

SCI7660C

CMOS DC/DC CONVERTER

T-57-11

DESCRIPTION

The SCI7660C CMOS DC/DC Converter features high operational performance with low power dissipation. The booster generates a doubled output voltage from the input. It is possible to drive the LSI that need another power supply than main power supply. (LCD drivers•Analog LSI etc.) Its very low power requirement makes it ideal to supply handy equipments with power.

FEATURES

- ① High performance with low power dissipation
- ② Simple conversion of $V_{DD}(+5V)$ to $-V_i(-5V)$, $+2V_i(+10V)$
- ③ Output current30mA Max ($V_{DD}=5V$)
- ④ Power conversion efficiency95% Typ
- ⑤ Cascade connection (two device connected $V_{DD}=5V$, $V_o = -10V$)
- ⑥ Low power.....Ideal for dry cell battery
- ⑦ On-chip CR oscillator
- ⑧ Package.....8 pin DIP (plastic)

BLOCK DIAGRAM

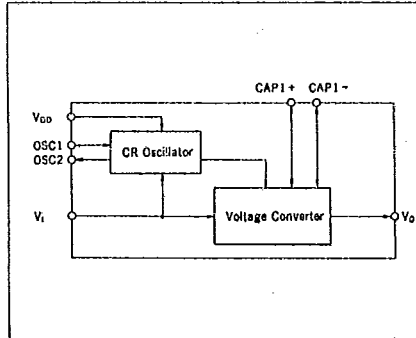

VOLTAGE RELATIONS

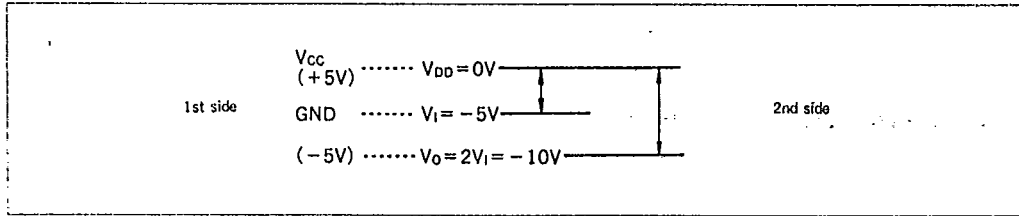

PIN CONFIGURATION

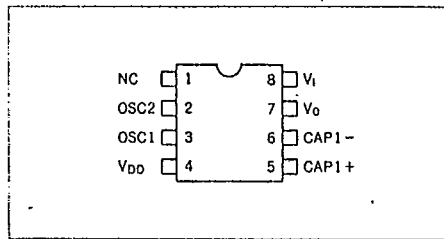

PIN DESCRIPTION

Pin Name	Pin No.	Functions
OSC1	3	Oscillation resistor connection terminal
OSC2	2	
VDD	4	Power supply terminal (positive, system supply Vcc)
CAP1+	5	Terminal for connection of capacitor for booster (positive)
CAP1-	6	Terminal for connection of capacitor for booster (negative)
Vo	7	Output terminal at doubling
Vi	8	Power supply terminal (negative, system supply GND)

■ ABSOLUTE MAXIMUM RATINGS

(V_{DD}=0V, T_a=25°C)

Parameter	Symbol	Ratings	Unit
Input voltage	V _I	-10.0 to 0.5	V
Output voltage	V _O	-20.0 to V _I	V
Power dissipation	P _D	300	mW
Operating temperature	T _{opr}	-30 to 85	°C
Storage temperature	T _{stg}	-65 to 150	°C
Soldering temperature and time	T _{sol}	260°C, 10s (at lead)	—

■ ELECTRICAL CHARACTERISTICS

(V_{DD}=0V, T_a=-30 to 85°C)

Parameter	Symbol	Conditions	Min	Typ	Max	Unit
Input voltage	V _I		-8.0	—	-1.2	V
Output voltage	V _O		-16.0	—	—	V
Booster current consumption	I _{opr}	R _L =∞, R _{osc} =1MΩ, V _I =-5V	—	40	70	μA
Stationary current	I _Q	R _L =∞, V _I =-8V	—	—	2.0	μA
Output impedance	R _O	I _O =10mA, V _I =-5V	—	80	120	Ω
Booster power conversion efficiency	P _{eff}	I _O =5mA, V _I =-5V	90	95	—	%
Input leakage current	I _{LI}	OSC1 terminal, V _I =-8V	—	—	2.0	μA
Oscillation frequency	f _{osc}	R _{osc} =1MΩ, V _I =-5V	16	20	24	kHz

■ RECOMMENDED OPERATING CONDITIONS

(V_{DD}=0V, T_a=-30 to 85°C)

Parameter	Symbol	Conditions	Min	Typ	Max	Unit
Booster start voltage	V _{STA1}	R _{osc} =1MΩ, C _L /C ₂ ≤1/20 *1 C ₂ ≥10μF T _a =-20 to 85°C	—	—	-1.2	V
	V _{STA2}	R _{osc} =1MΩ	—	—	-2.2	V
Booster stop voltage	V _{STP}	R _{osc} =1MΩ	-1.2	—	—	V
Output load resistance	R _L		R _L min *2	—	—	Ω
Output current	I _O		—	—	30	mA
Oscillation frequency	f _{osc}		10	—	30	kHz
External resistance for oscillation	R _{osc}		680	—	2000	kΩ
Capacitor for booster	C ₁ , C ₂ , C ₃		3.3	—	—	μF

*1 Recommended circuitry in low voltage operation is shown below.

*2 R_L min depends on input voltage as shown below.

Recommended circuit in low voltage operation

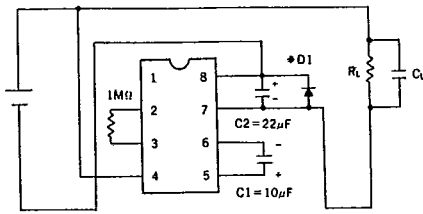

*D1 (VF(1F=1mA) ≤ 0.6V)

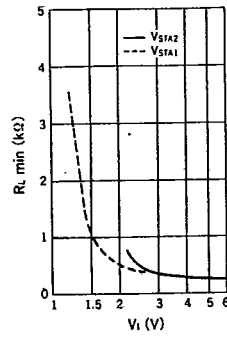

■ TYPICAL PERFORMANCE CHARACTERISTICS

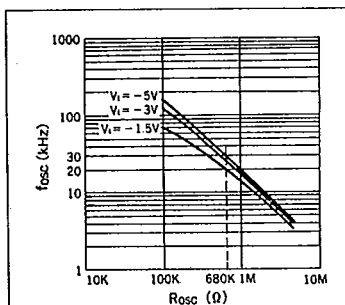

Fig. 1 Oscillation Frequency (f_{osc}) vs. External-Resistance (R_{osc})

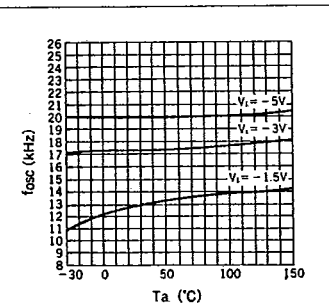

Fig. 2 Oscillation Frequency (f_{osc}) vs. Temperature (T_a)

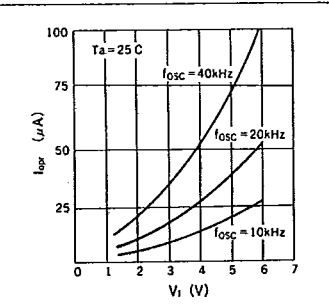

Fig. 3 Booster Current Consumption (I_{opr}) vs. Input Voltage (V_i)

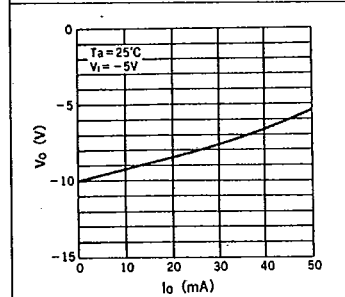

Fig. 4 Output Voltage (V_o) vs. Output Current (I_o)

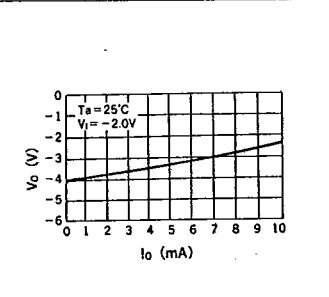

Fig. 5 Output Voltage (V_o) vs. Output Current (I_o)

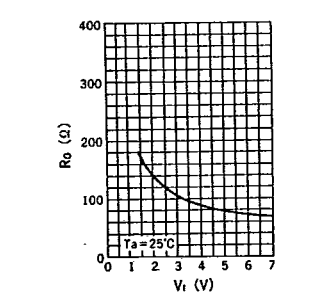

Fig. 6 Output Impedance (R_o) vs. Input Voltage (V_i)

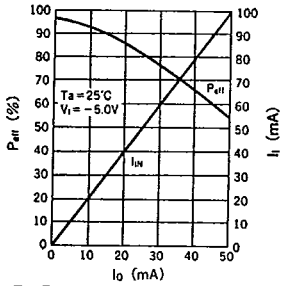

Fig. 7 Power Conversion Efficiency (P_{eff})/Input Current (I_i) vs. Output Current (I_o)

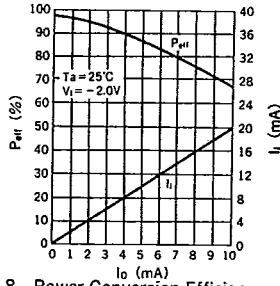

Fig. 8 Power Conversion Efficiency (P_{eff})/Input Current (I_i) vs. Output Current (I_o)

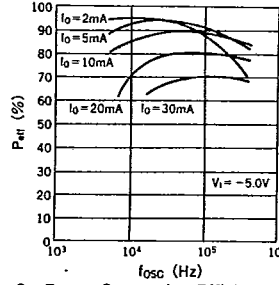

Fig. 9 Power Conversion Efficiency (P_{eff}) vs. Oscillation Frequency (f_{osc})

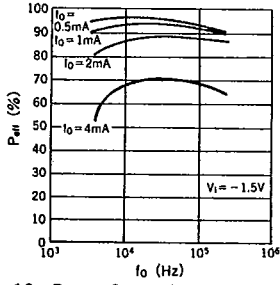
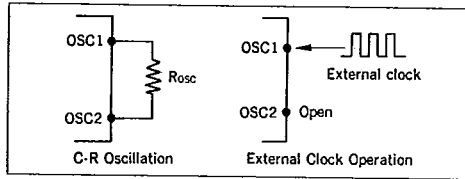

Fig. 10 Power Conversion Efficiency (P_{eff}) vs. Oscillation Frequency (f_{osc})

CIRCUIT DESCRIPTION

C-R Oscillator

The SC17660C contains a C-R oscillator for internal oscillation. It consists of an external resistor R_{osc} connected between the OSC1 pin and OSC2 pin.



Voltage Converters

The voltage converters double the input supply voltage (V_i) using clocks generated by the C-R oscillator. A doubled voltage can be obtained with a booster capacitor between CAP+ and CAP-, and with an external smoothing capacitor between V_i and V_o .

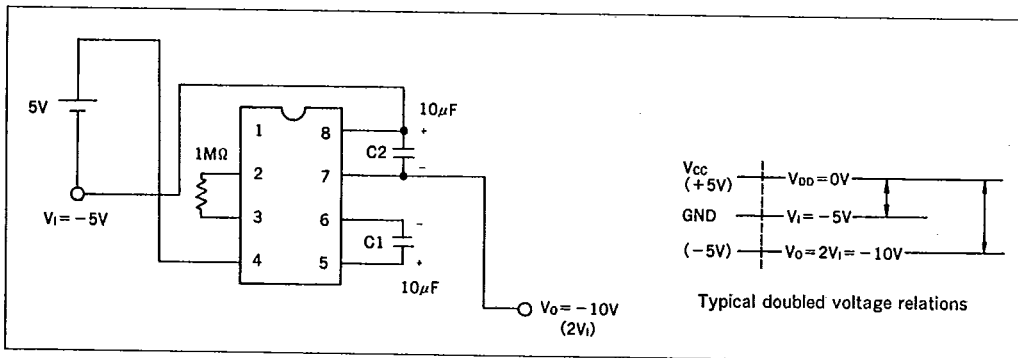

EXAMPLE OF APPLICATIONS

- Parallel Connection (Output impedance can be reduced by parallel connections.)

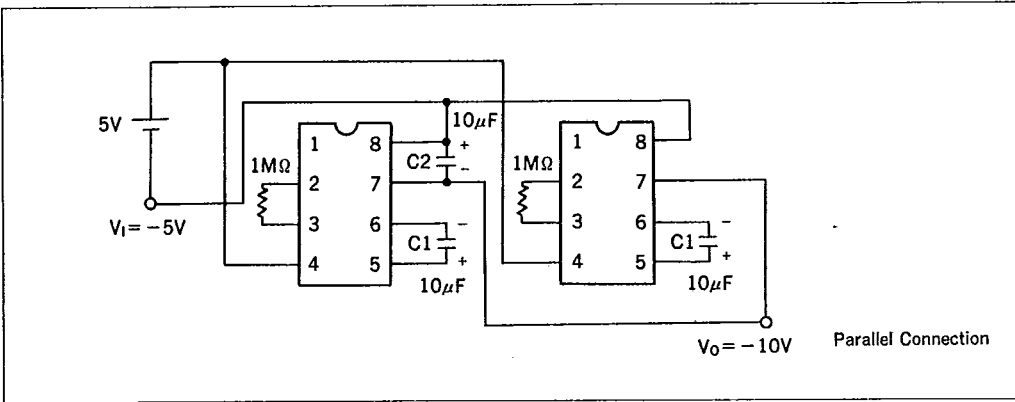

- Positive Voltage Conversion (Input voltage can be doubled toward the positive side with diode.)

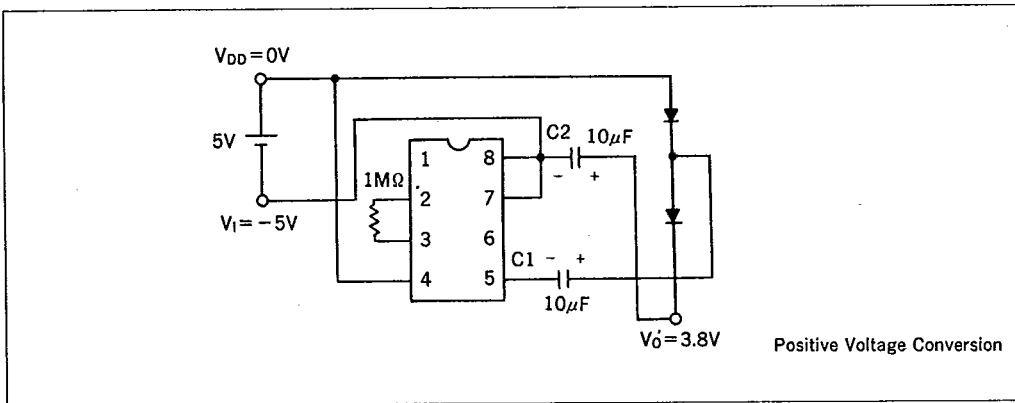

- Cascade Connection (Cascade connection of SC17660C further increase the output voltage. Note, however, that the cascade connection increase the output impedance.)

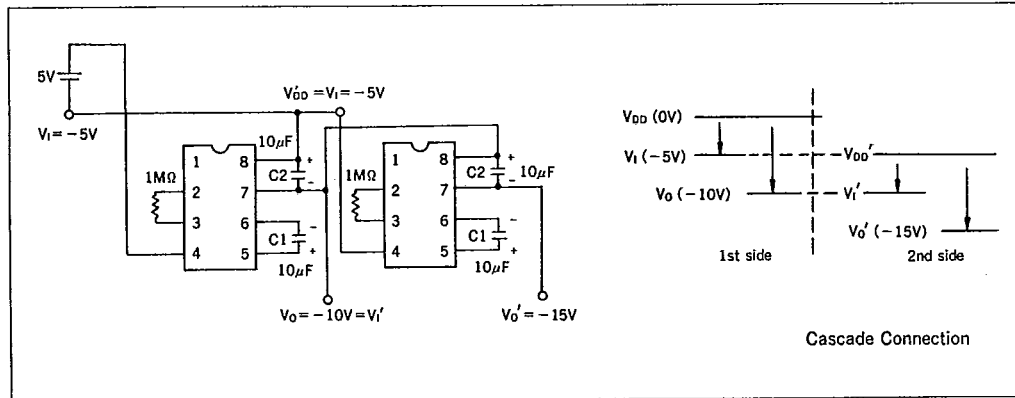

● Negative Voltage Conversion+Positive Voltage Conversion (This circuit produces outputs of -10V and +3.8V from the -5V input by combination of voltage doubler circuit and positive voltage conversion circuit.)

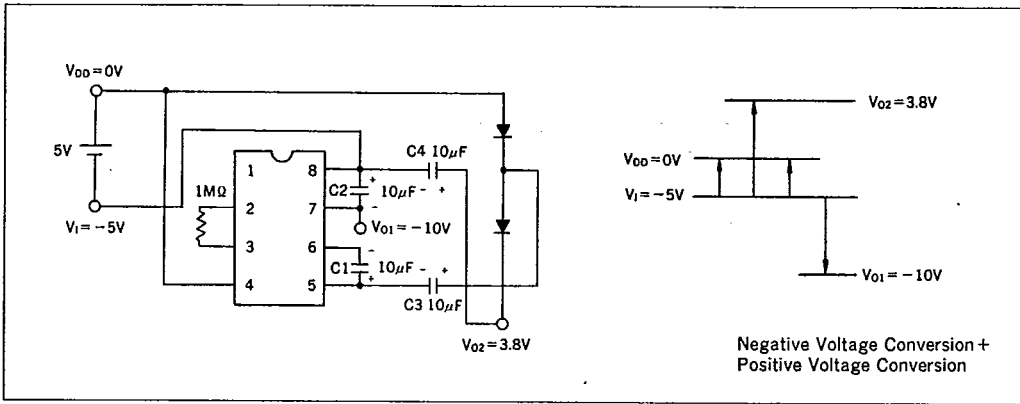

■ PACKAGE DIMENSIONS

