



Dual N-Channel Enhancement Mode Field Effect Transistor

PRODUCT SUMMARY		
V _{DSS}	I _D	R _{DS(ON)} (mΩ) Max
30V	7A	30 @ V _{GS} = 10V 50 @ V _{GS} = 4.5V

FEATURES

- Super high dense cell design for low R_{DS(ON)}.
- Rugged and reliable.
- Surface Mount Package.

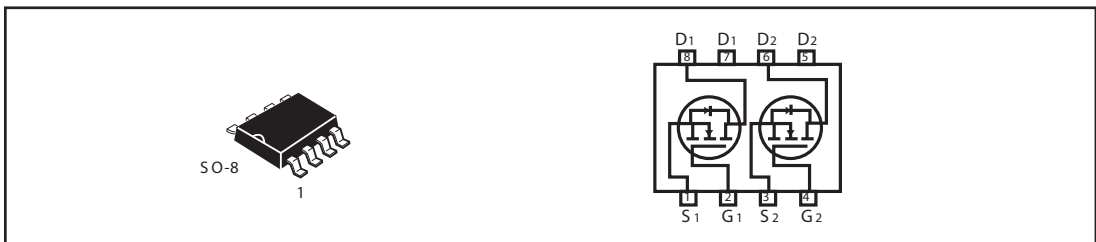

ABSOLUTE MAXIMUM RATINGS (T_A=25 °C unless otherwise noted)

Parameter	Symbol	Limit	Unit
Drain-Source Voltage	V _{DS}	30	V
Gate-Source Voltage	V _{GS}	±20	V
Drain Current-Continuous ^a @ T _J =125 °C -Pulsed ^b (300us Pulse Width)	I _D	7.0	A
	I _{DM}	28	A
Drain-Source Diode Forward Current ^a	I _S	2.8	A
Maximum Power Dissipation ^a	P _D	2.5	W
Operating Junction and Storage Temperature Range	T _J , T _{STG}	-55 to 150	°C

THERMAL CHARACTERISTICS

Thermal Resistance, Junction-to-Ambient ^a	R _{θJA}	50	°C/W
--	------------------	----	------

S DM6912

N-Channel ELECTRICAL CHARACTERISTICS (T_A=25°C unless otherwise noted)

Parameter	Symbol	Condition	Min	Typ ^c	Max	Unit
OFF CHARACTERISTICS						
Drain-Source Breakdown Voltage	BV _{DSS}	V _{GS} =0V, I _D =250uA	30			V
Zero Gate Voltage Drain Current	I _{DSS}	V _{DS} =24V, V _{GS} =0V			1	uA
Gate-Body Leakage	I _{GSS}	V _{GS} = ±20V, V _{DS} =0V			±100	nA
ON CHARACTERISTICS^b						
Gate Threshold Voltage	V _{GS(th)}	V _{DS} =V _{GS} , I _D = 250uA	1	1.8	3	V
Drain-Source On-State Resistance	R _{DS(ON)}	V _{GS} =10V, I _D = 6.0A			30	m ohm
		V _{GS} = 4.5V, I _D = 5.0A			50	m ohm
On-State Drain Current	I _{D(ON)}	V _{DS} = 5V, V _{GS} =10V	30			A
Forward Transconductance	g _{FS}	V _{DS} = 5V, I _D = 6.0A		16		S
DYNAMIC CHARACTERISTICS^c						
Input Capacitance	C _{ISS}	V _{DS} =15V, V _{GS} = 0V f=1.0MHz		510		pF
Output Capacitance	C _{OSS}			235		pF
Reverse Transfer Capacitance	C _{RSS}			56		pF
SWITCHING CHARACTERISTICS^c						
Turn-On Delay Time	t _{D(ON)}	V _{DD} = 15V, I _D = 1A, V _{GEN} = 10V, R _L = 15 Ω R _{GEN} = 10 Ω		21	40	ns
Rise Time	t _r			20	40	ns
Turn-Off Delay Time	t _{D(OFF)}			27	55	ns
Fall Time	t _f			115	230	ns
Total Gate Charge	Q _g	V _{DS} =15V, I _D = 1A, V _{GS} =10V		13	20	nC
		V _{DS} =15V, I _D = 1A, V _{GS} =4.5V		6	10	nC
Gate-Source Charge	Q _{gs}	V _{DS} =15V, I _D = 1A, V _{GS} =10V		2.1		nC
Gate-Drain Charge	Q _{gd}			2		nC

S DM6912

ELECTRICAL CHARACTERISTICS ($T_A=25^\circ\text{C}$ unless otherwise noted)

Parameter	Symbol	Condition	Min	Typ ^c	Max	Unit
DRAIN-SOURCE DIODE CHARACTERISTICS^b						
Diode Forward Voltage	V_{SD}	$V_{GS} = 0V, I_s = 5.0A$		0.76	1.1	V

Notes

- a. Surface Mounted on FR4 Board, $t \leq 10\text{sec}$.
- b. Pulse Test: Pulse Width $\leq 300\mu\text{s}$, Duty Cycle $\leq 2\%$.
- c. Guaranteed by design, not subject to production testing.

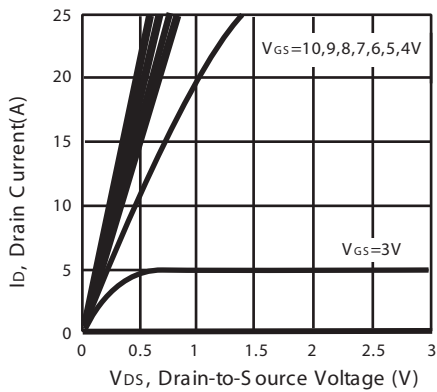

Figure 1. Output Characteristics

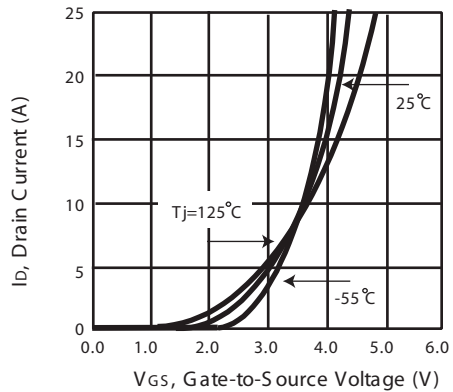

Figure 2. Transfer Characteristics

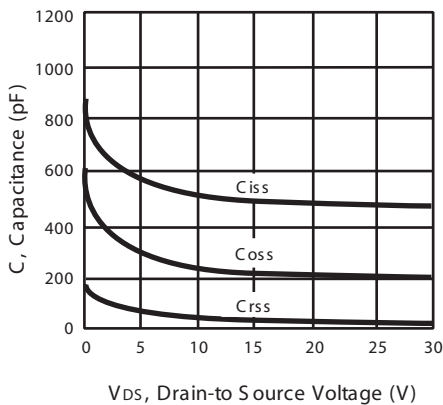

Figure 3. Capacitance

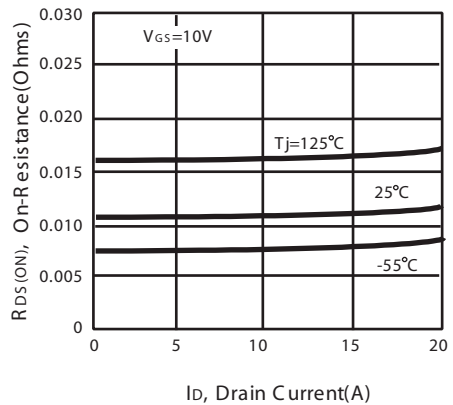

Figure 4. On-Resistance Variation with Drain Current and Temperature

S DM6912

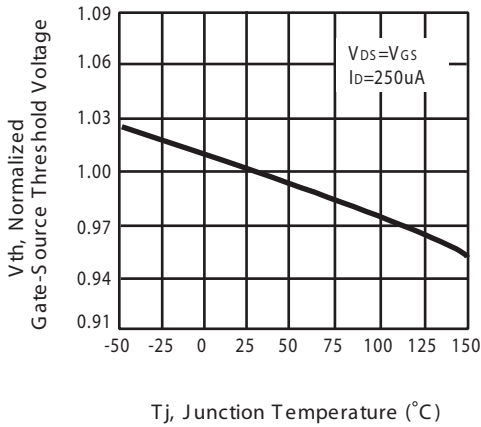

Figure 5. Gate Threshold Variation with Temperature

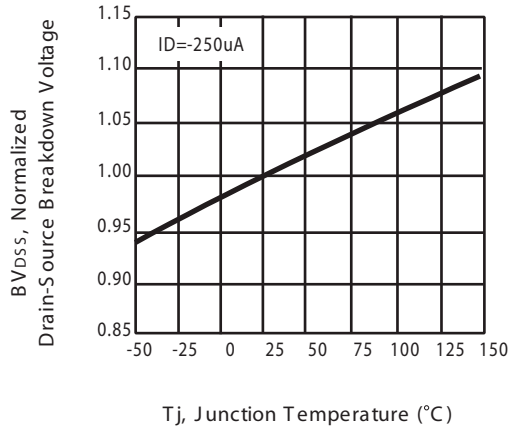

Figure 6. Breakdown Voltage Variation with Temperature

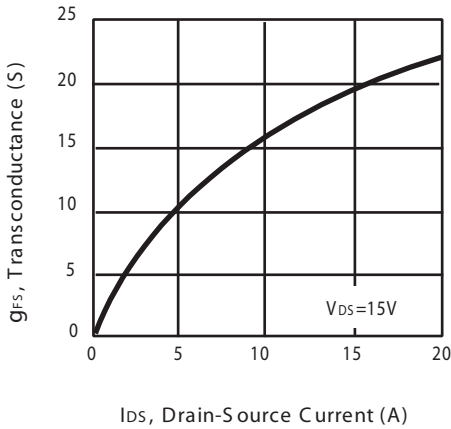

Figure 7. Transconductance Variation with Drain Current

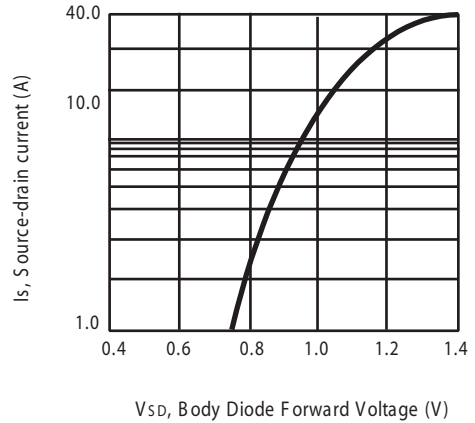

Figure 8. Body Diode Forward Voltage Variation with Source Current

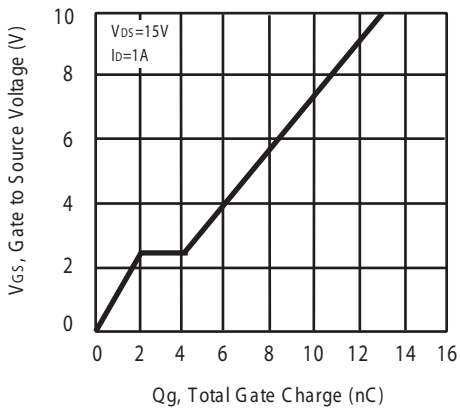

Figure 9. Gate Charge

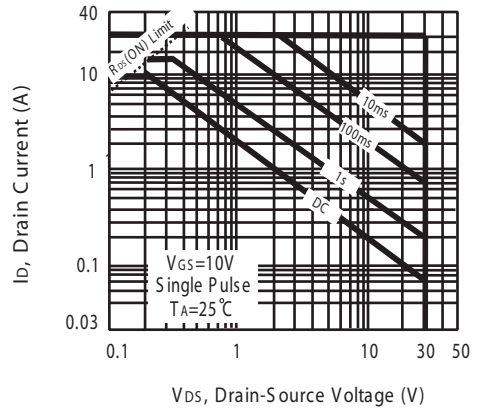

Figure 10. Maximum Safe Operating Area

SDM6912

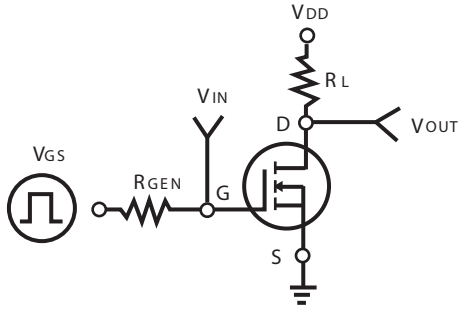

Figure 11. Switching Test Circuit

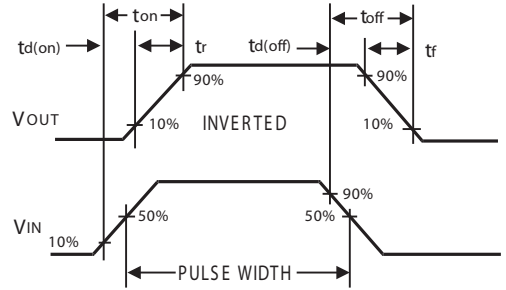

Figure 12. Switching Waveforms

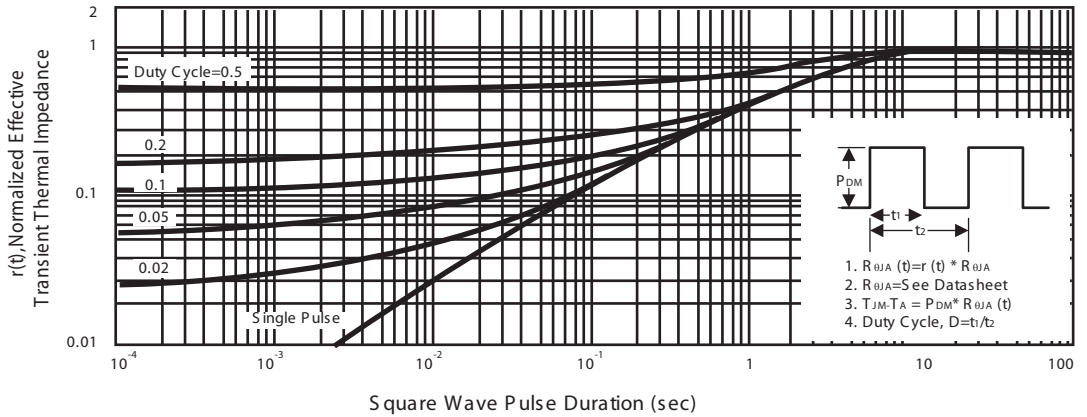

Figure 13. Normalized Thermal Transient Impedance Curve