

FM IF SYSTEM (DIFFERENTIAL PEAK DETECTION)

TA7411AP is an IC designed for car tuner, and is provided with the flexible muting function and station detection function which allow the features realized conforming to the specification of the tuner.

- . Differential 6-stage IF limiter amplifier
- . Signal meter output
- . Differential peak detector
- . Station detection
- . Bands muting
- . Signal strength muting
- . Effective against multi-path distortion with adoption of differential peak detector.
- . Low distortion ratio can be realized with single tuning coil. (Typically 0.05% at 1kHz \pm 75kHz dev.)
- . Sensitivity and attenuation of signal strength muting, and sensitivity and band of stop signal can freely be set with the external resistance.
- . Signal meter output proportional to input signal strength can be obtained.
- . Excellent S/N
- . Operating power supply voltage : $V_{opr}=7\sim 16V$ ($T_a=25^\circ C$)

MAXIMUM RATINGS ($T_a=25^\circ C$)

CHARACTERISTIC	SYMBOL	RATING	UNIT
Supply Voltage	V_{CC}	16	V
Power Dissipation	PD	750	mW
Operating Temperature	T_{opr}	-30~85	$^\circ C$
Storage Temperature	T_{stg}	-55~150	$^\circ C$
Tuning Indication Current	$I_{7 \max}$	20	mA
External Overflow Current	$I_{13 \max}$	5	mA

Note: Derated above $T_a=25^\circ C$ in the proportion of 6mW/ $^\circ C$.

Unit in mm

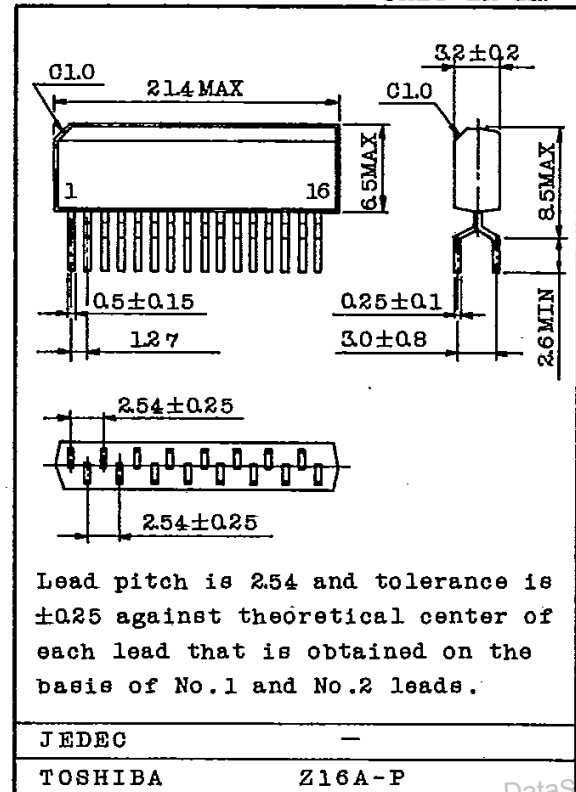

Lead pitch is 2.54 and tolerance is ± 0.25 against theoretical center of each lead that is obtained on the basis of No.1 and No.2 leads.

Weight : 0.99g

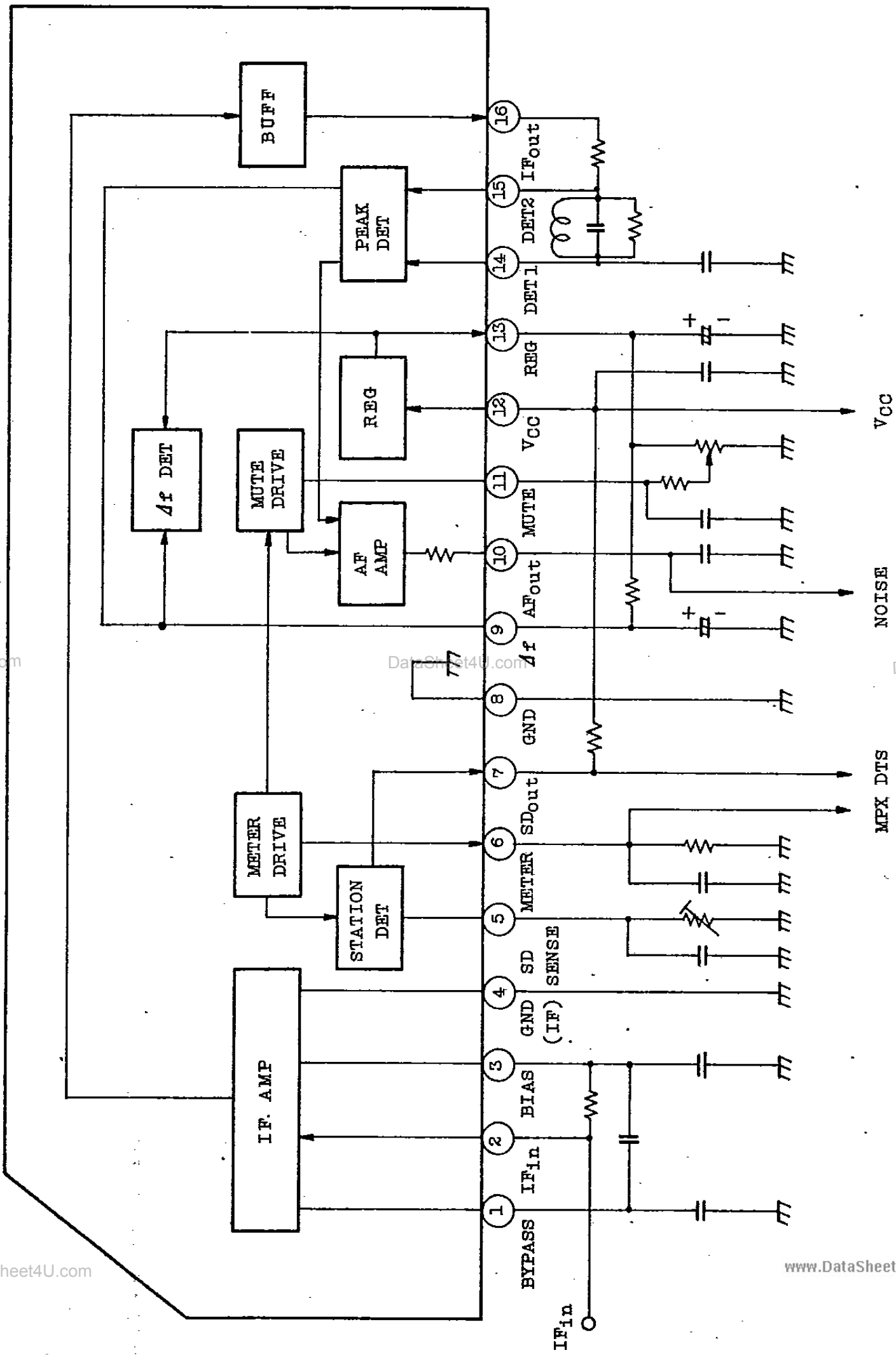

NOISE
CANCELLER
TA7409F

MPX DTS
TA7413AP

et4U.com

DataSheet4U.com

DataShee

ELECTRICAL CHARACTERISTICS

(Unless otherwise specified, $V_{CC}=8.5V$, $f_i=10.7MHz$, $Dev=\pm 75kHz$, $f_m=400Hz$, $V_i=80dB\mu$
 $SW1=D$ (Mute off), $SW2=off$)

CHARACTERISTIC	SYMBOL	TEST CIR-CUIT	TEST CONDITION	MIN.	TYP.	MAX.	UNIT
Quiescent Supply Current	ICCQ		$V_i=0$, $SW1=C$	10	13.5	19	mA
Limiting Sensitivity	$V_i(lim)$			-	33	35	dB μ
Detection Output	VOD			350	430	550	mV _{rms}
Total Harmonic Distortion Ratio 1	THD1		$Dev=\pm 22.5kHz$, $R_D=1.3k\Omega$	-	0.04	0.5	%
Total Harmonic Distortion Ratio 2	THD2		Adjust R_D to optimum value. ($R_D=1.3k\Omega+500\Omega VR$)	-	0.05	-	%
Signal to Noise Ratio	S/N			71	78	-	dB
AM Rejection Ratio	AMR		AM=30%	-	55	-	dB
Signal Meter Output	VSM1		$V_i=0dB\mu$	-	0	0.3	V
	VSM2		$V_i=50dB\mu$	0.5	1.5	2.5	
	VSM3		$V_i=70dB\mu$	2.6	3.8	5.1	
	VSM4		$V_i=100dB\mu$	5.4	6.5	6.8	
Soft Muting Attenuation	ATT1		$SW1=A$	35	40	45	dB
	ATT2		$SW1=B$	4	7	11	
Soft Muting Driving Voltage	VMD1		$V_i=50dB\mu$	-	3.5	-	V
	VMD2		$V_i=80dB\mu$				
Detuning Attenuation	ATT3		$\Delta f=\pm 200kHz$	18	24	30	dB
Muting Band	BW(M)		$RBW=12k\Omega$ $VOD=-3dB$	-	± 70	-	kHz
Station Detection Sensitivity	VSS		POINT: $SW2=ON$, $V_{SD}=L \rightarrow H$	0.8	1	1.2	V
Station Detection Control Voltage	VSC1		$V_i=50dB\mu$	-	1.5	-	V
	VSC2		$V_i=80dB\mu$				
Station Detection Band	BW(S)		$RBW=12k\Omega$	-	± 45	-	kHz
AF Output Resistance	R_O			-	5	-	k Ω

DIFFERENTIAL PEAK DETECTION

Differential peak detection method is for detecting each peak of the voltage variation of e_1 and e_2 when the input frequency varies and for obtaining the detection output by means of subtracting and amplifying the DC voltage with the differential amplifier. The levels of e_1 and e_2 for the input frequency are shown in Fig. 2. The point at which e_1 becomes minimum is the point at which Z_1 becomes minimum, here Z_1 is the input impedance of the following stage.

The impedance Z_1 is obtained as follows:

$$Z_1 = \frac{1+S^2 L(C_1+C_2)}{SC^2(1+S^2LC_1)} \dots\dots (1)$$

(Provided $S=jw$.)

f_L is obtained by the expression (2) as follows.

$$f_L = \frac{1}{2\pi\sqrt{L(C_1+C_2)}} \dots\dots (2)$$

Since the point at which e_2 becomes minimum is the point at which L and C_1 resonate parallel, f_H is obtained by the expression (3) as follows.

$$f_H = \frac{1}{2\pi\sqrt{LC_1}} \dots\dots (3)$$

When the inductive susceptance of L and C_1 becomes the half of capacitive susceptance, the frequency f_0 is expressed by the following formula (4).

$$f_0 = \frac{1}{2\pi\sqrt{L(C_1+C_2/2)}} \dots\dots (4)$$

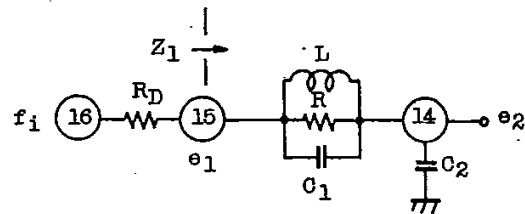

Fig. 1

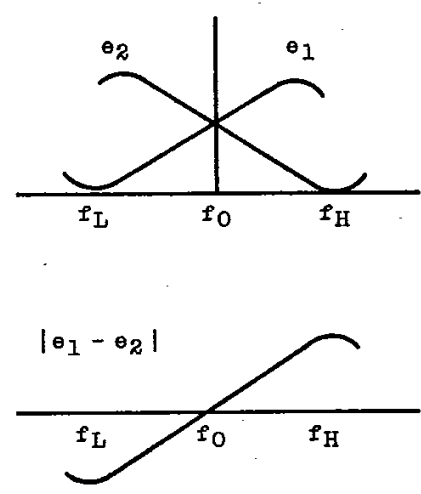

Fig. 2

The detection output is determined by the width of f_H-f_L . That is, the detection output is proportional to the ratio of C_1 to C_2 ... (C_1/C_2). Fig. 3 shows the variation of the detection output against C_2 as $C_1=15\text{pF}$. Take care for the fact when C_1/C_2 is reduced to reduce the detection output, the detection band is widened and S/N ratio is reduced to a certain degree. Therefore, for reducing the detection output with S/N kept high, supplement R to adjust the output.

In the conventional quadrature detection, for obtaining the low distortion ratio, multiple tuned coil is necessitated and resulting in the high cost and the complicated adjustment (to coincide f_0 with the minimum distortion value is rather difficult.)

In TA7411AP, since f_0 adjustment is performed with the coil and the distortion with R_D , not only the cost but also the adjusting time is reduced.

When R_D is made into the fixed resistance, $R_D=1.3\text{k}\Omega$ becomes the reference for the minimum distortion (in the condition of the test circuit).

As described above, the linearity of the S curve (distortion) is determined by R_D value. On the other hand, R_D value is necessary to be varied also with the value of C_1 and C_2 in order to make the distortion minimum and especially the influence on C_2 is the greatest.

Set R_2 against C_1 and C_2 referring to the graph in Fig. 3.

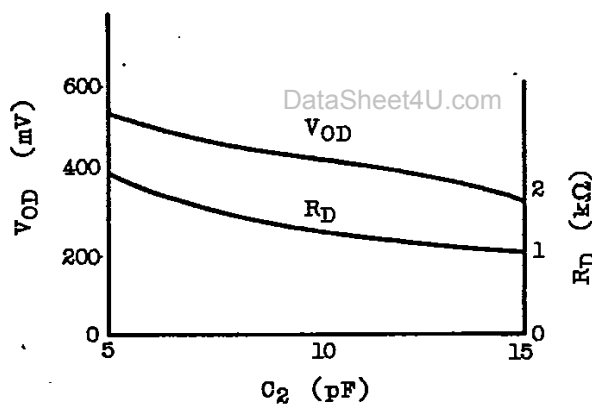

Fig. 3

Note: THD is adjusted to minimum with R_D .

SIGNAL STRENGTH MUTING CHARACTERISTICS

The muting of TA7411AP is composed of AF amplifier of which gain varies with the control voltage and the control voltage generating circuit (Mute Drive), of which voltage is proportional to the signal meter output.

Fig. 4 shows the outline of the muting circuit. The signal meter output is converted into the current I by $10k\Omega$ externally attached to 8 pin, and $1/3 I$ current is output to 11 pin through 1:1/3 current mirror circuit. This current is converted into the control voltage by the externally connected V_M and RMS.

Since the output current at 11 pin is about 0, the attenuation at quiescent state is determined almost by the value of V_M . By means of connecting the volume R_{MD} of about $10k\Omega$ to the constant voltage output of $4.8V$ (13 pin), V_M is set by the volume output. The variation ratio (gradient) of attenuation of the detection output is determined by input signal level, that is by the ratio of the variation of 11 pin voltage V_{MD} to the variation of the signal meter voltage. Therefore, the larger RMS grows, the sharper the gradient becomes. Usually, the value of RMS is considered satisfactory with $33k\Omega$.

The muting amount against 11 pin voltage V_{MD} is shown in Fig. 4.

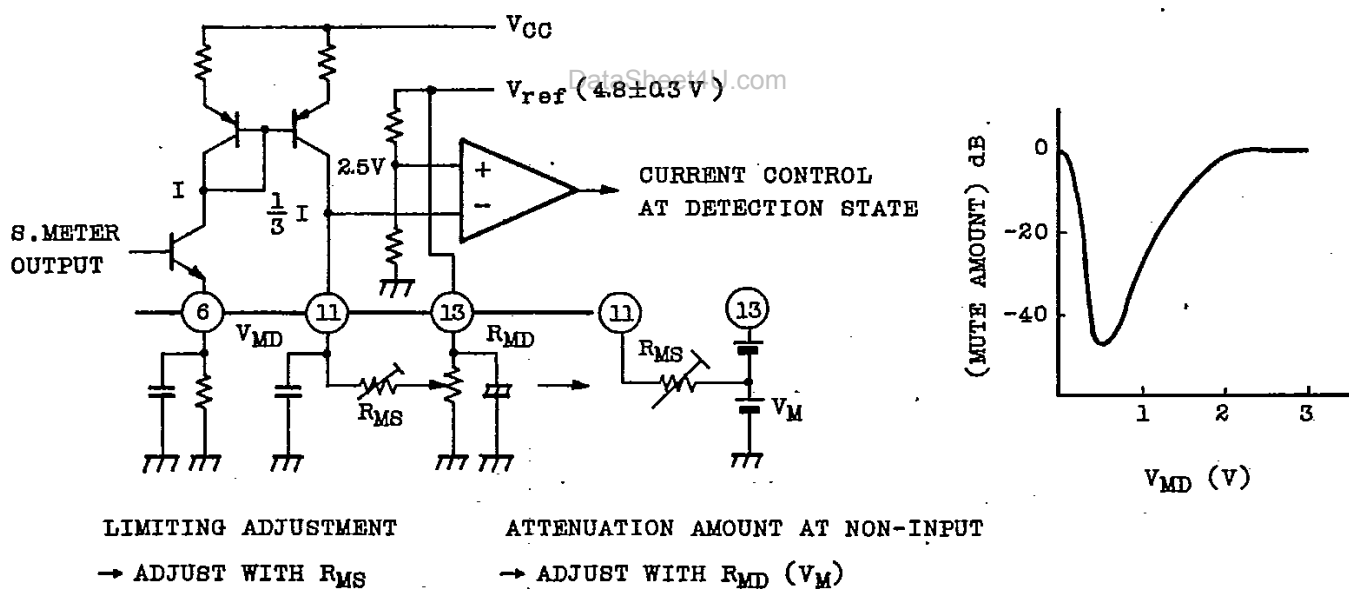

Fig. 4

DETUNED MUTING CHARACTERISTICS

The positive and negative currents proportional to S curve are generated at AFC terminal 9 pin.

The alternating current portion is smoothed by the external capacitor and the DC voltage is generated at 9 pin through R_{BW} connected to 13 pin. When the variation of DC voltage generated at R_{BW} exceeds about $\pm 0.7V$, Δf detection circuit (Δf Det) is operated, 11 pin voltage is made to about 1.5V and AF amplifier is attenuated by about 20dB.

The width of the detuning muting is determined by the resistance value of R_{BW} , however, since the width is varied by the detection output described above, set the value of R_{BW} after setting the detection output.

The muting characteristics when R_{BW} is changed in the test circuit condition is shown in Fig. 5.

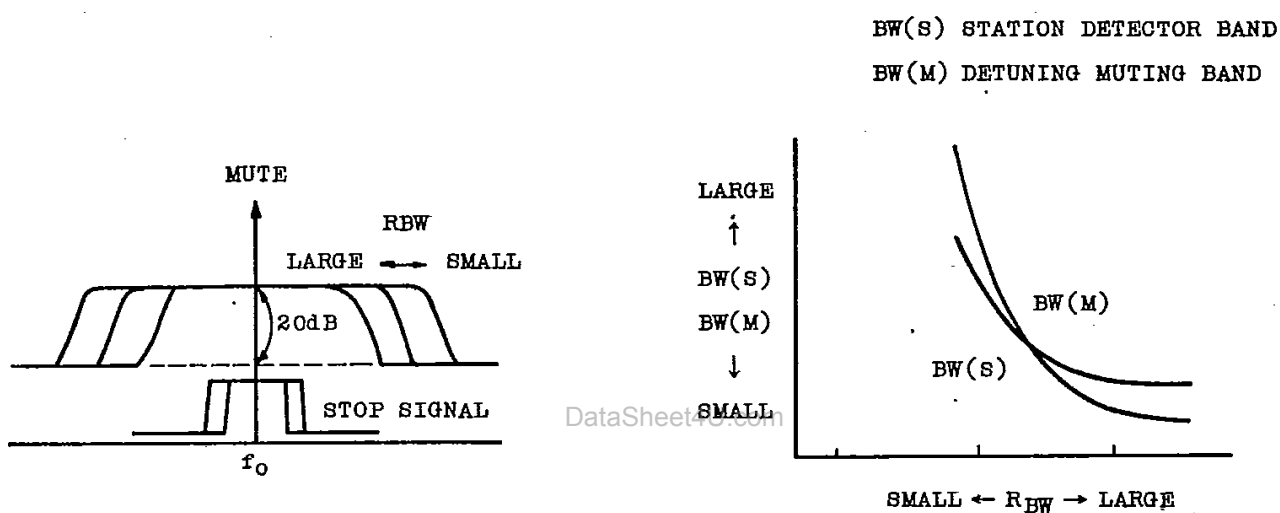

Fig. 5

The station detector (stop signal generator of DTS) detects the detuning frequency with the input signal strength and Δf detection circuit (Δf Det), and output it through the AND circuit.

As shown in Fig. 6, the signal meter output is converted into the current I by the $10k\Omega$ resistance connected to 6 pin, and the current I is output at 5 pin through the current mirror circuit.

This current is converted into voltage through R_{SS} . On the other hand, 5 pin is internally connected to the minus input of the comparator in which $1V$ is added to the plus input. Therefore, by means of changing R_{SS} value connected to 5 pin, the stop signal sensitivity can be adjusted.

The variable width of the stop signal sensitivity is about 40dB in IF input voltage (at $R_{SS}=2k\Omega \sim 10k\Omega$). The band width is varied by R_{BW} as shown in Fig. 5.

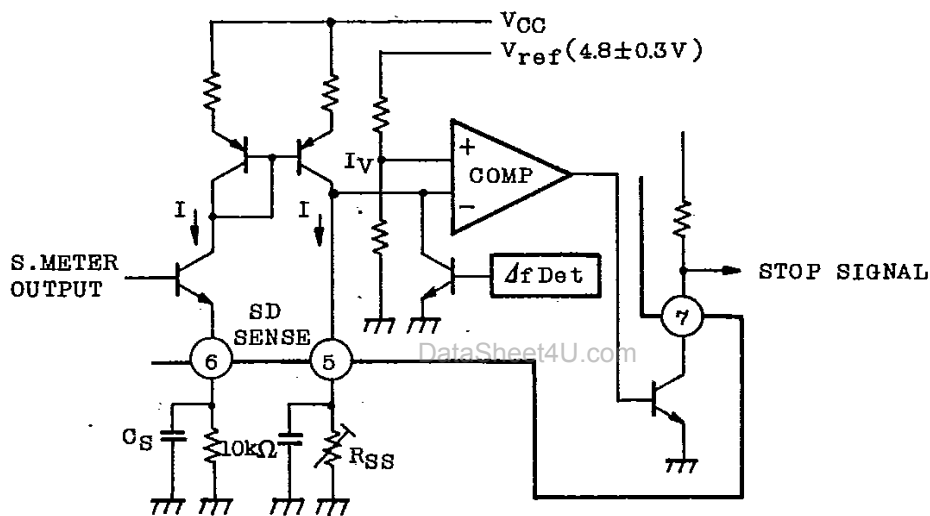

Fig. 6

ADJUSTING METHOD OF TA7411AP

- . Provide 10.7MHz, 80dB μ signal input.
- . Connect voltmeter between 9 pin and 13 pin.
- . Adjust T1 to set the voltmeter indication at about 0V.
- . Adjust R_D so as to make the detection distortion minimum.

CAUTION ON APPLICATION

- . When the capacity of the bypass capacitor C_S to be connected to S meter output 8 pin is considerably large, the audio signal depended on AM wave flows to make AMR characteristics deteriorated.

Application with 0.01 μ F or below is recommended.

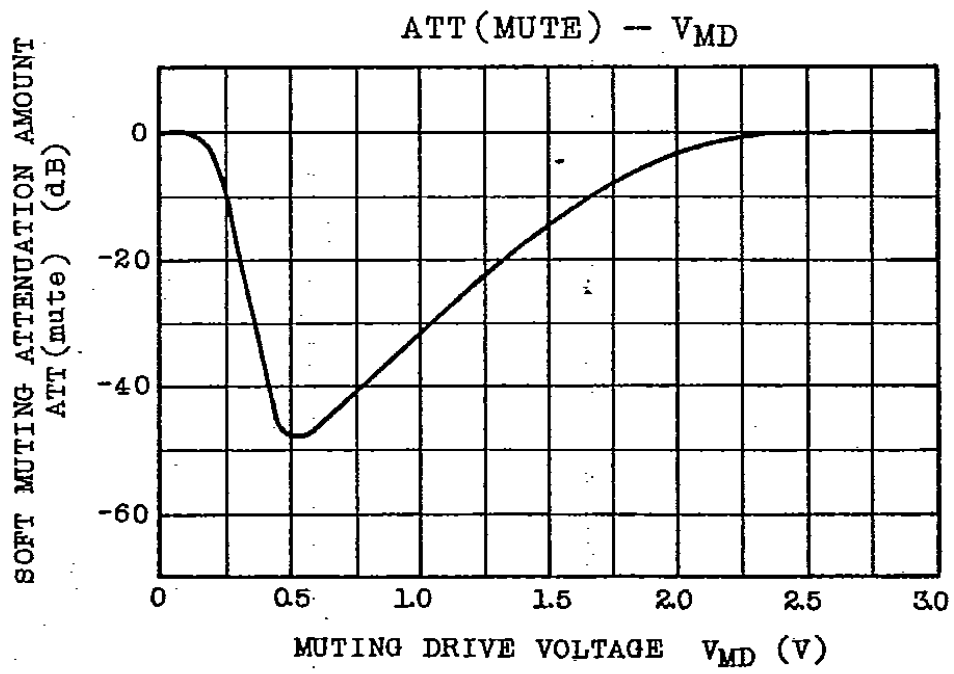
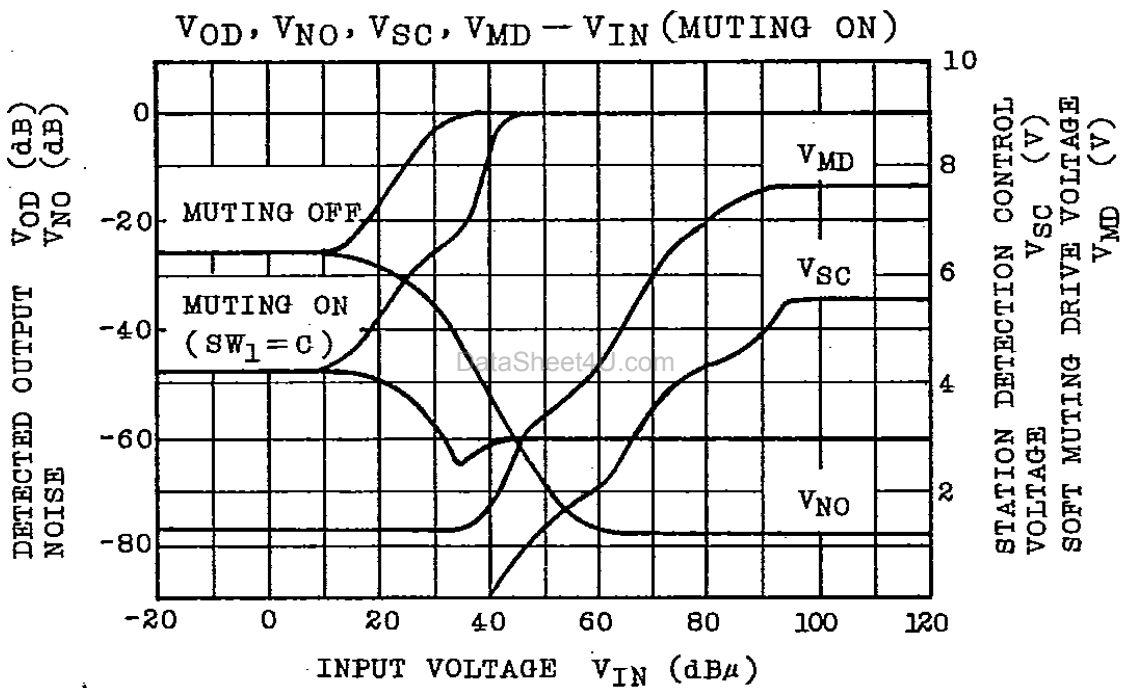
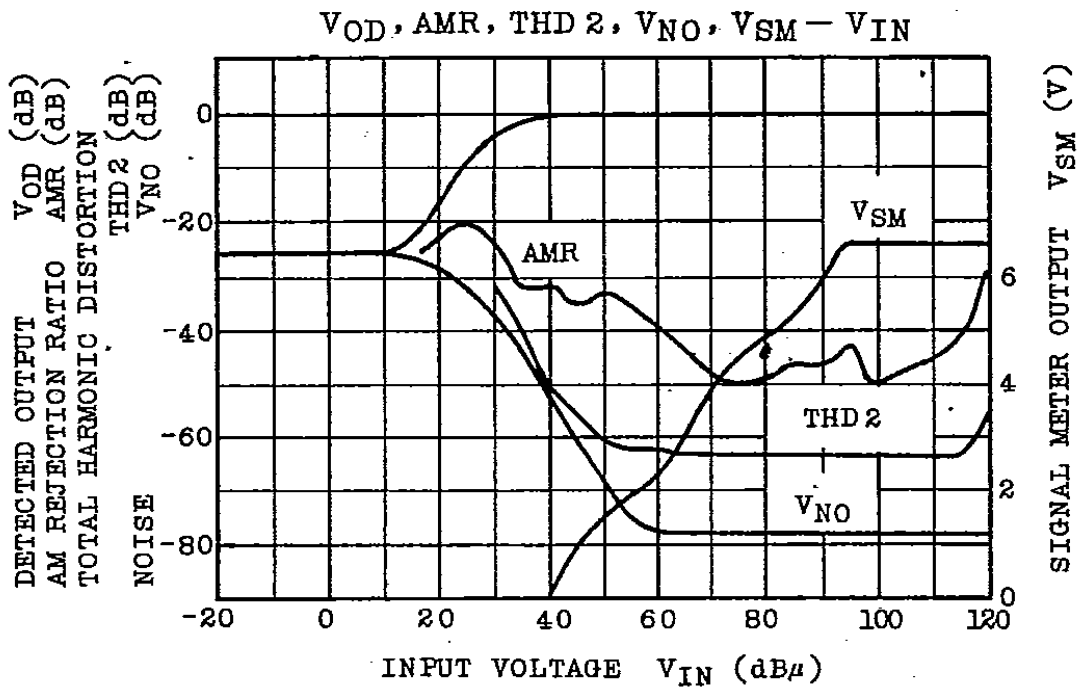

$V_{OD}, V_{NO} - V_{IN}$

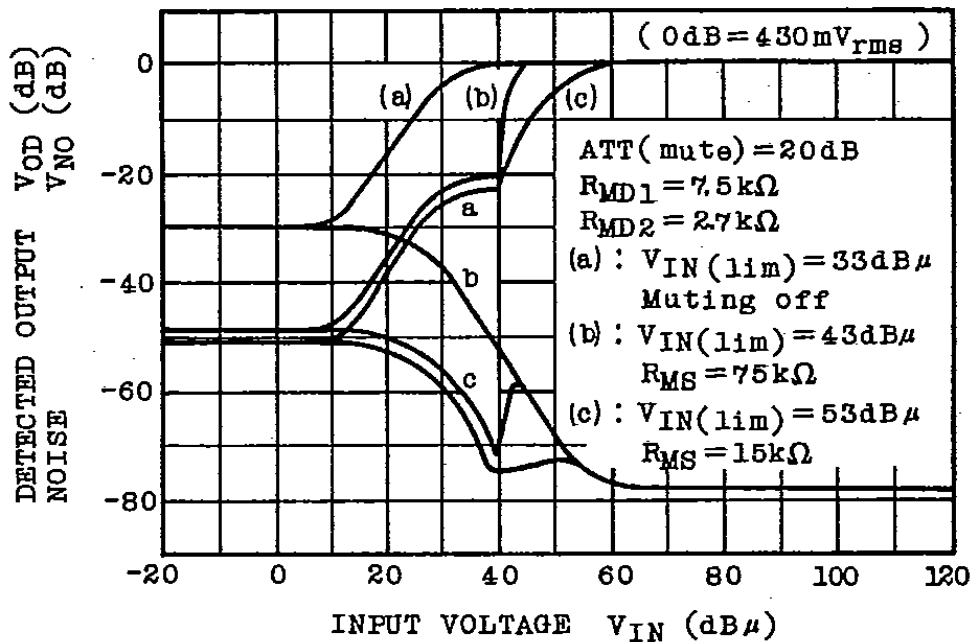

$V_{OD}, V_{NO} - V_{IN}$

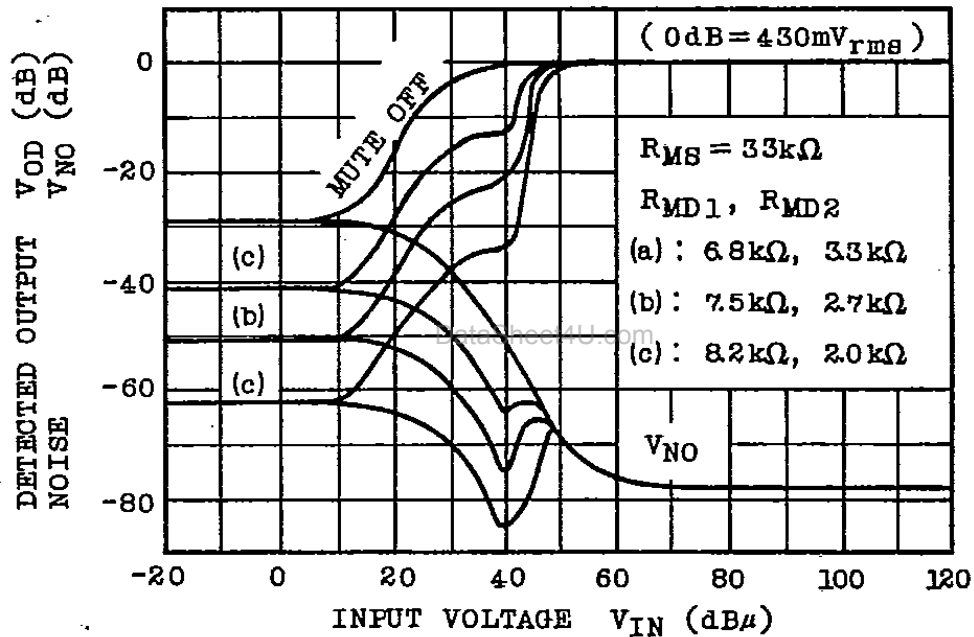

BW(M), BW(S) - R_{BW}

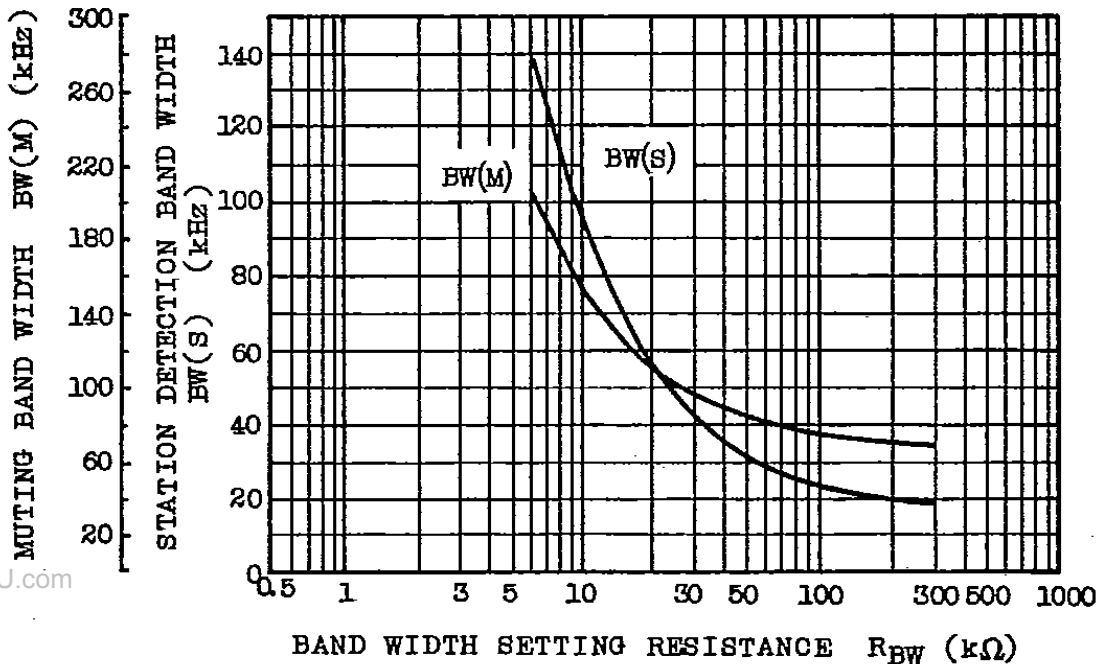

$V_{IN(lim)} - R_{MS}$

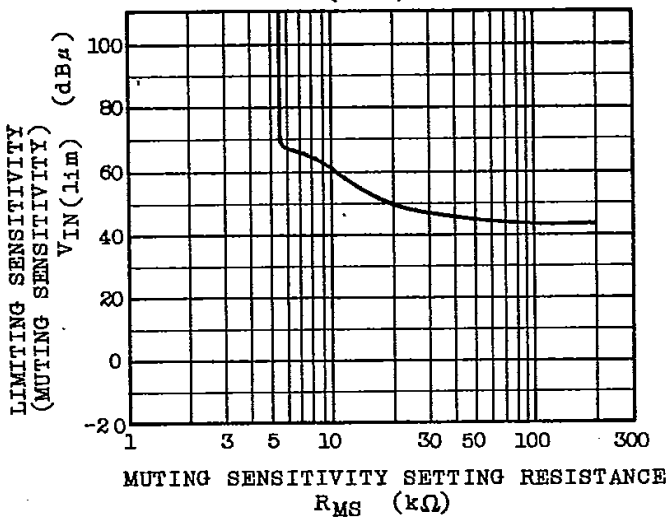

$V_{SS} - R_{SS}$

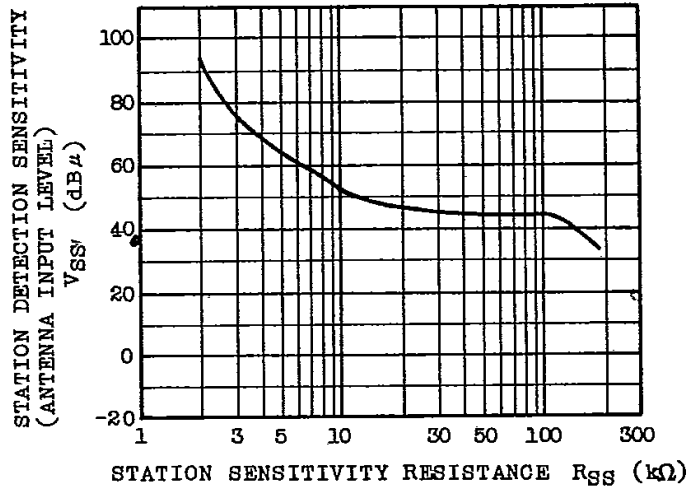

$V_{OD}, R_D - C_2$

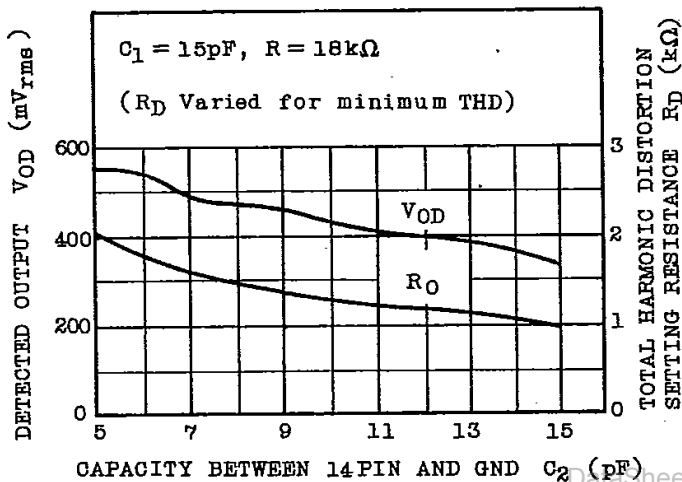

$V_{OD}, V_{SD} - f_i$

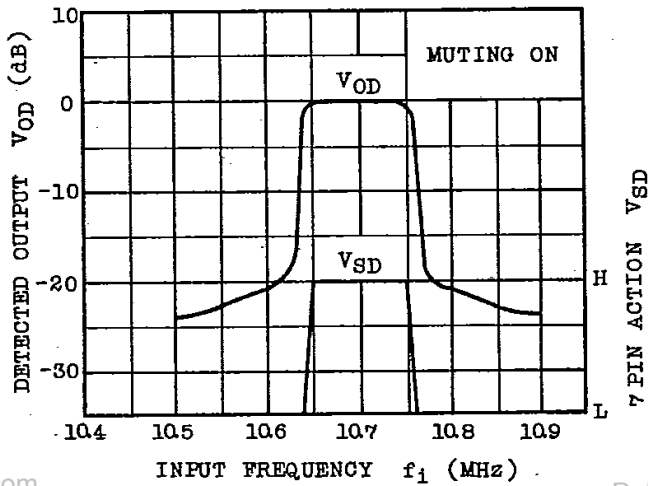

$V_{OD}, THD - V_{CC}$

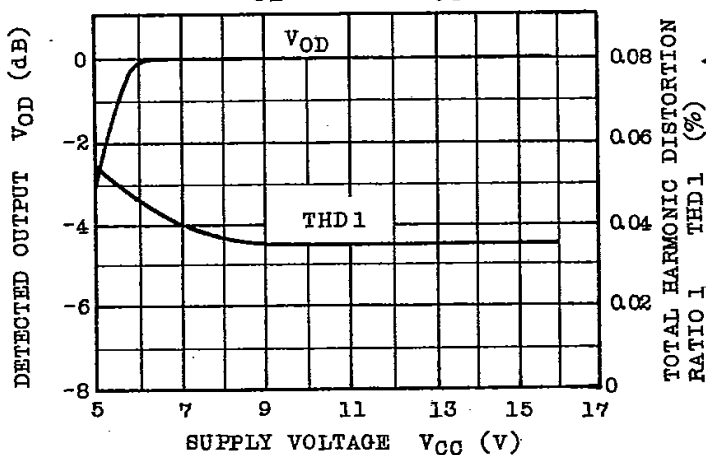

$AMR, V_{NO}, V_{IN(lim)} - V_{CC}$

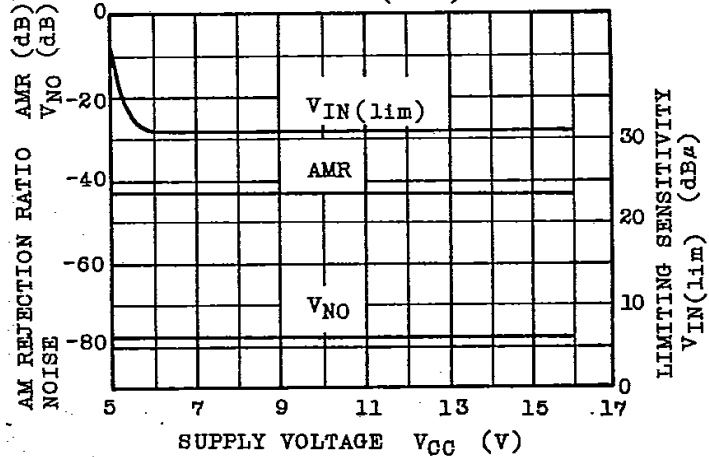

V_{AFC} - f₁

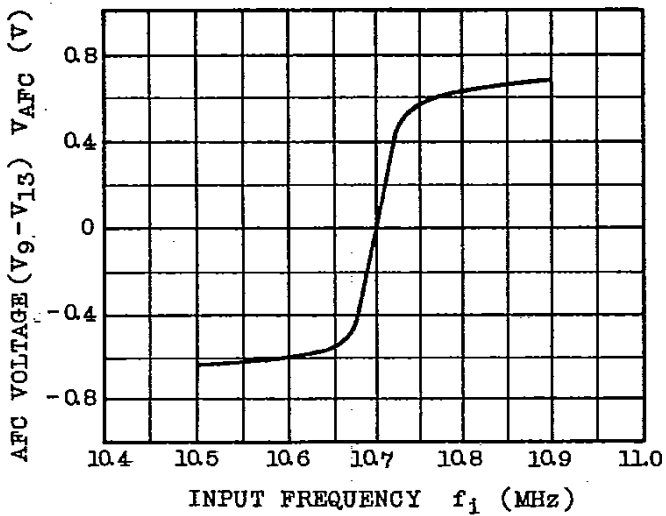

V_{AFC}, V_{ref} - V_{CC}

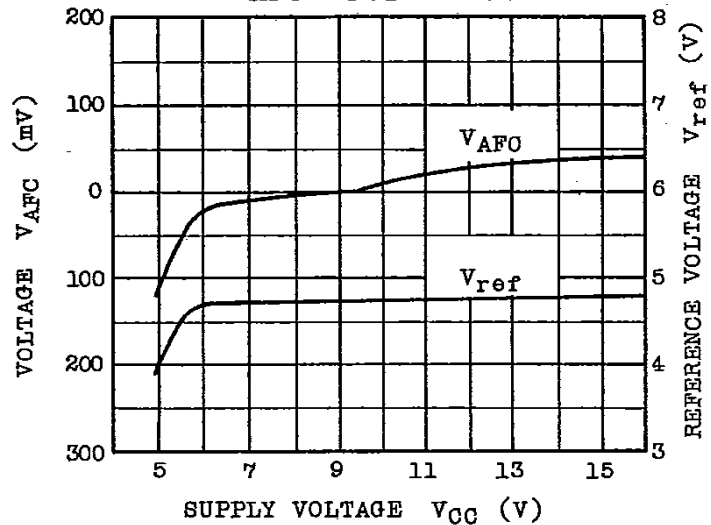

V_{SM} - V_{CC}

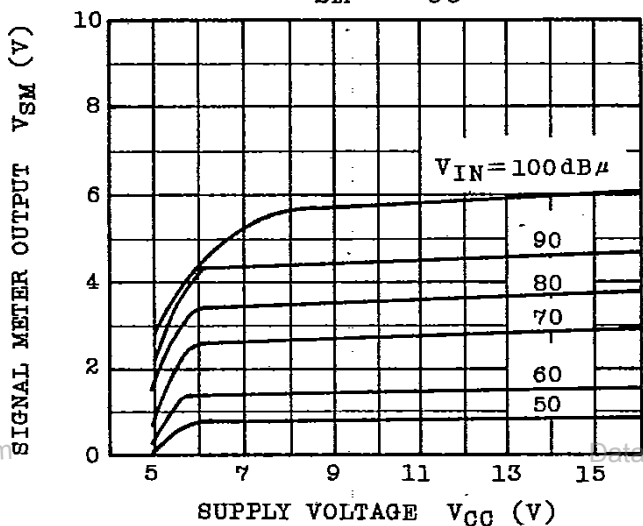

V_{IN(lim)} - T_a

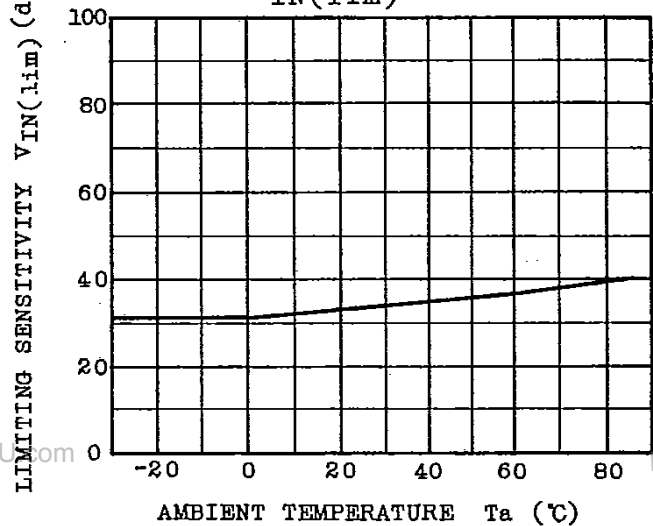

V_{OD} - T_a

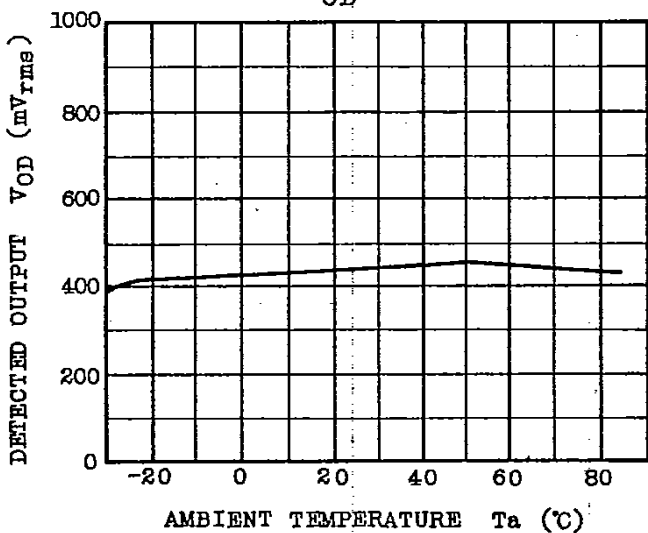

I_{CC} - T_a

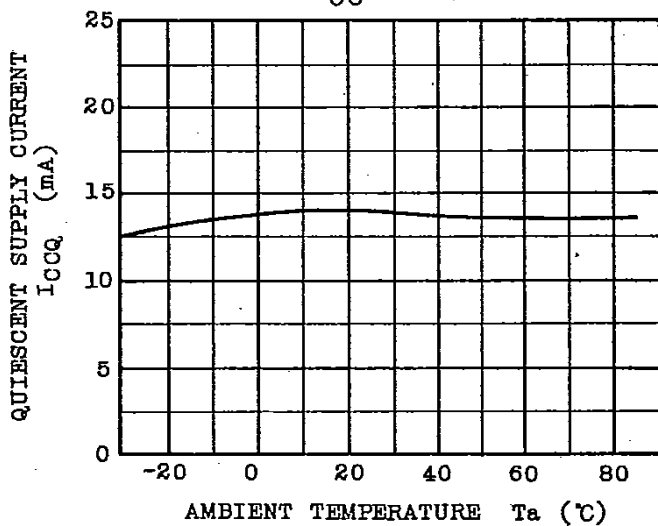

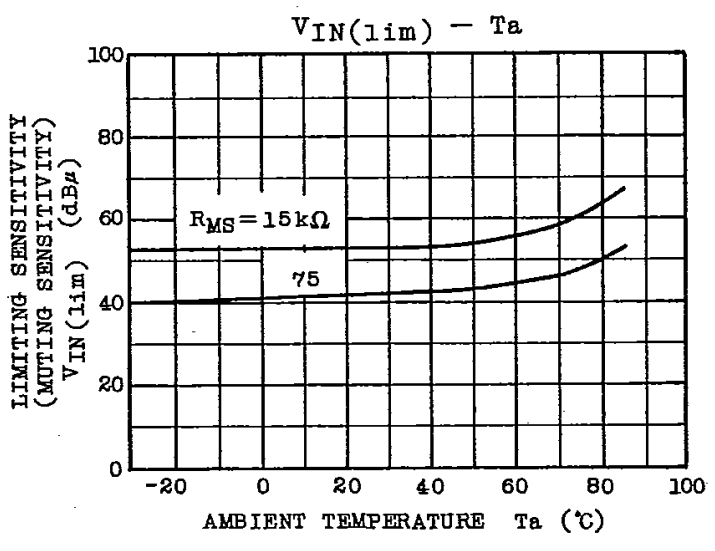
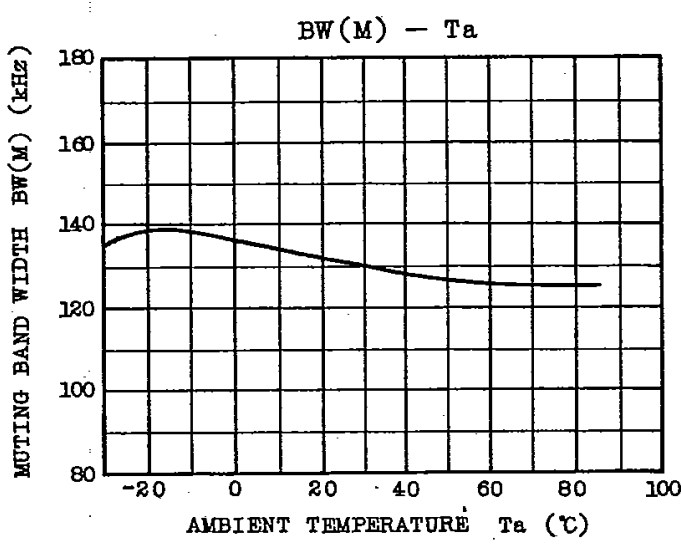
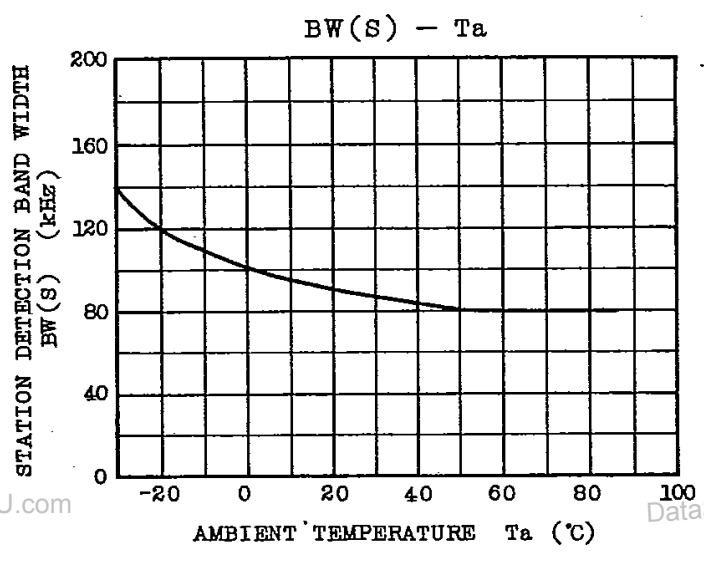
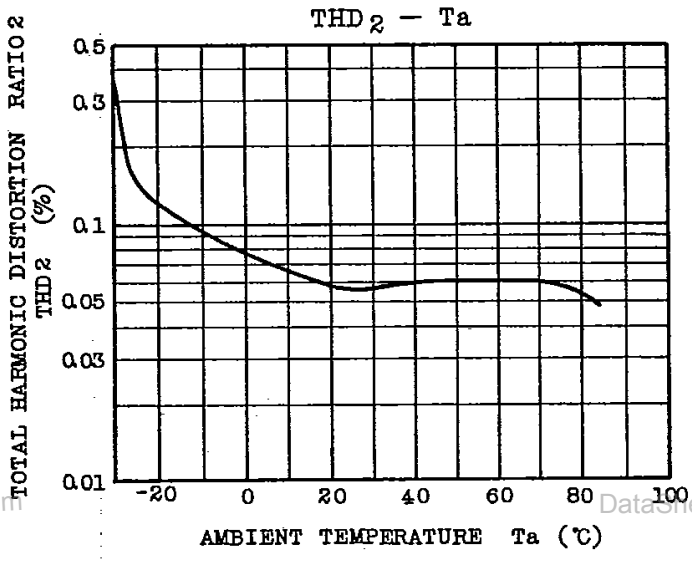
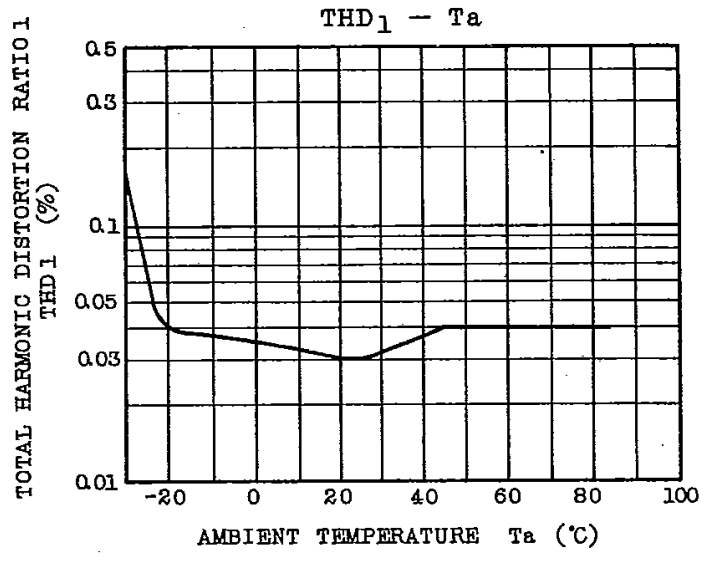
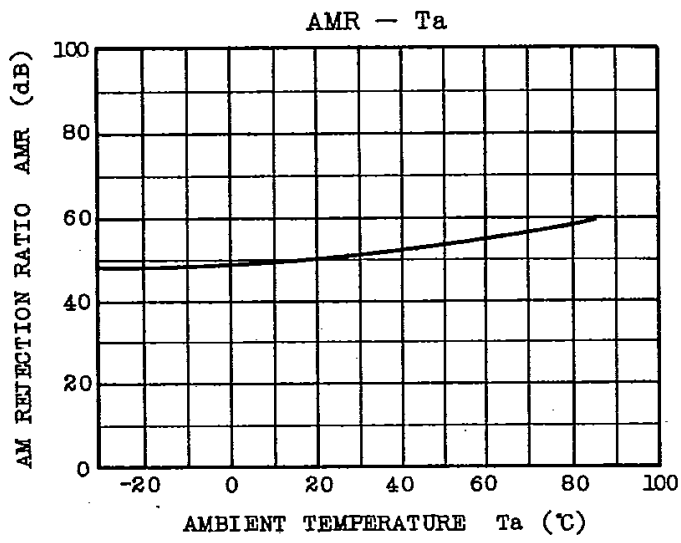

ATT₃ - Ta

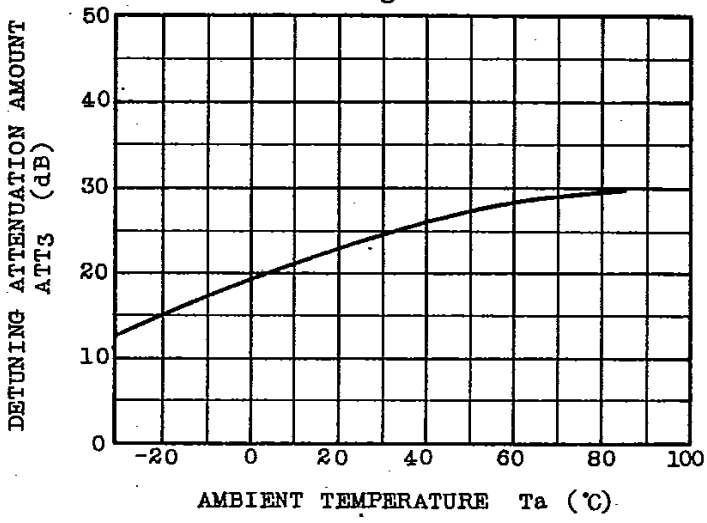

f₀ - Ta

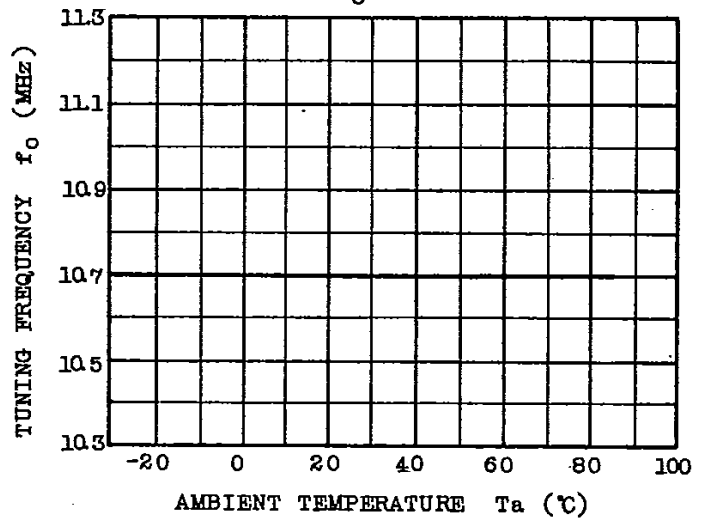

V_{SS} - Ta

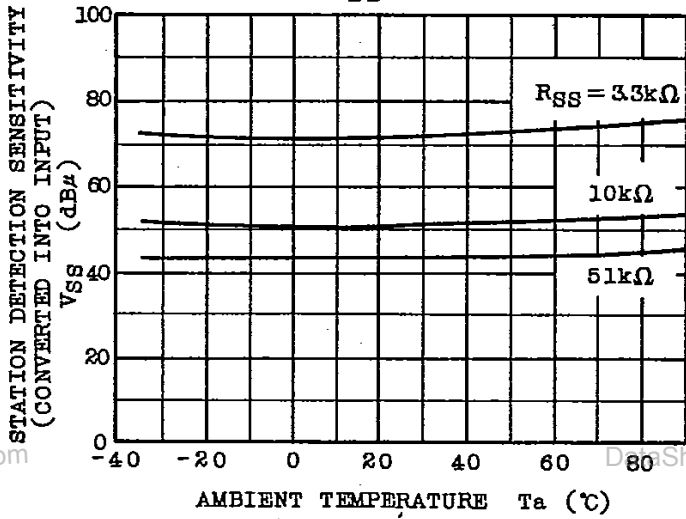

AMR, VOD, THD₂, V_{NO}, V_{SM} - V_{IN}

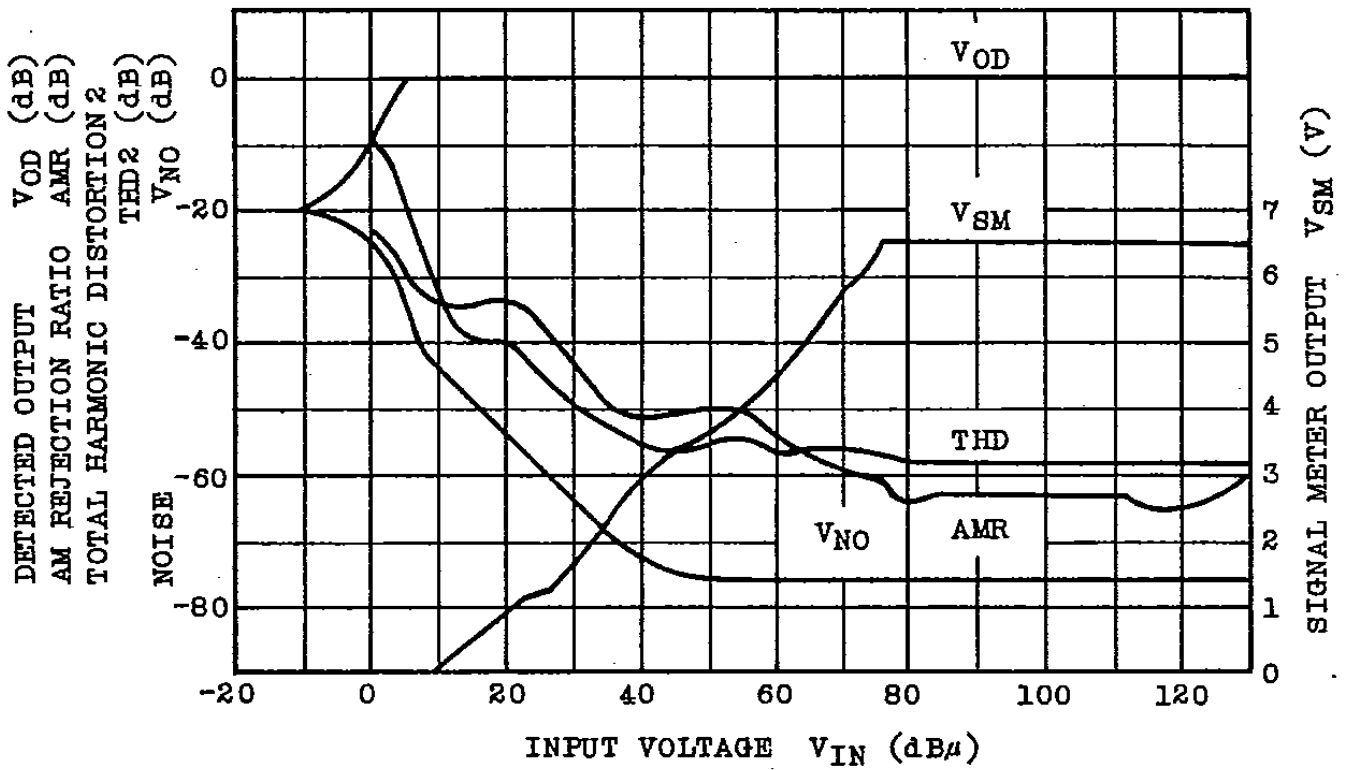

VOD, V_{NO} - V_{IN} (MUTING ON)

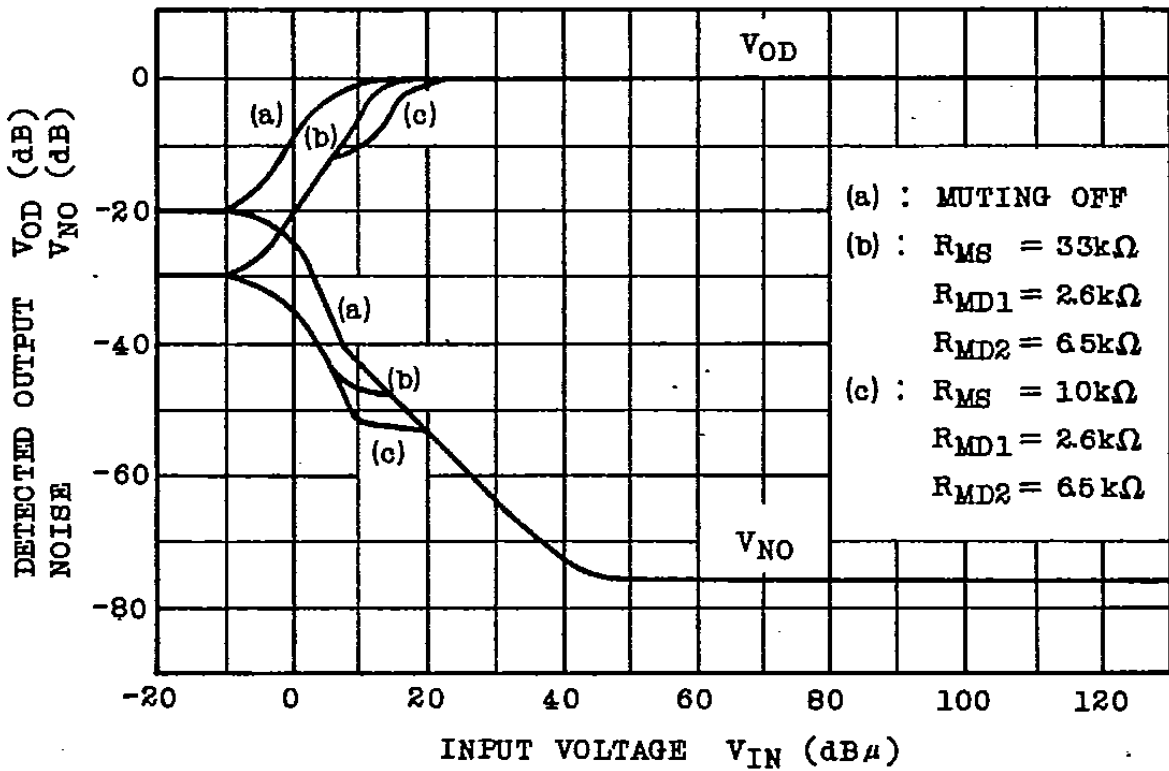

APPLICATION CIRCUIT (EXAMPLE) (High Cut and High Blend Action at the time of Multi-path) TA7411AP + TA7409P + TA7413AP

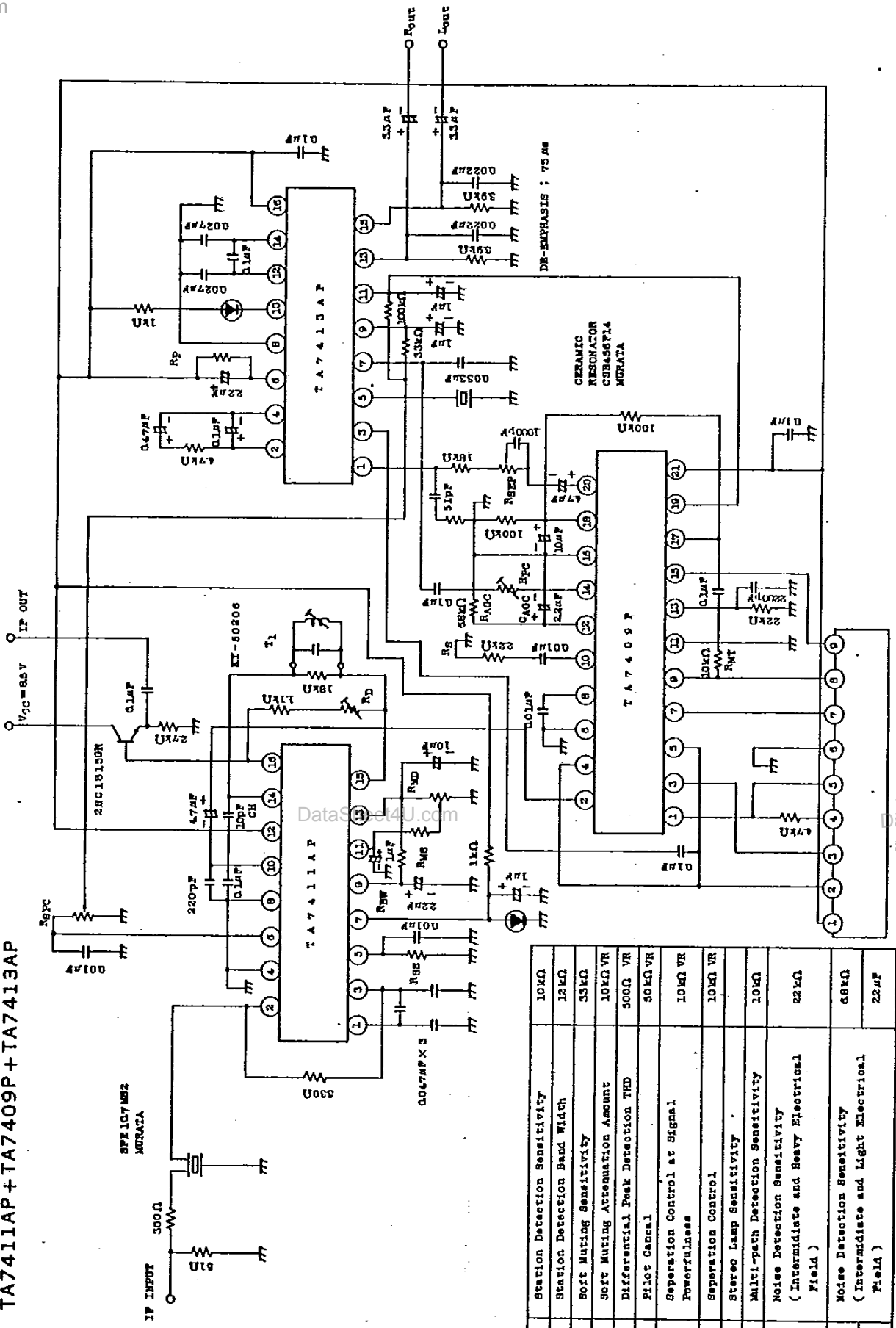

R _{gpc}	Station Detection Sensitivity	10kΩ
R _{gw}	Station Detection Band Width	12kΩ
R _{ms}	Soft Muting Sensitivity	33kΩ
R _{md}	Soft Muting Attenuation Amount	10kΩ VR
R _{pd}	Differential Peak Detection THD	500Ω VR
R _{pc}	Pilot Cancel	50kΩ VR
R _{spc}	Separation Control at Signal Powerfulness	10kΩ VR
R _{sef}	Separation Control	10kΩ VR
R _p	Stereo Lamp Sensitivity	
R _{wt}	Multi-path Detection Sensitivity	10kΩ
R _{ns}	Noise Detection Sensitivity (Intermediate and Heavy Electrical Field)	22kΩ
R _{noc}	Noise Detection Sensitivity (Intermediate and Light Electrical Field)	60kΩ
CA00		22μF

CR MODEL IN 1360B
MURATA

CR MODULE DN 1360B (MURATA)

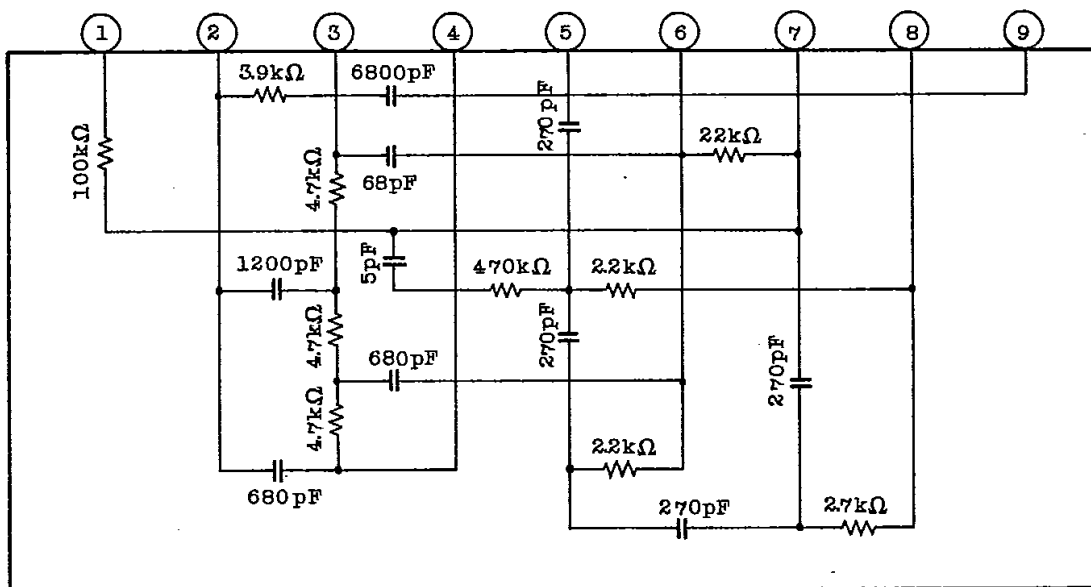

DATA OF COILS (TYP.)

COIL No.	STAGE	TEST FREQUENCY (MHz)	L (μH)	C ₀ (pF)	Q ₀	TURN				WIRE (mm)	NOTE
						1-2	2-3	1-3	4-6		
T1	DET	10.7		15	85				17	0.08 UEW	KY-50206 Temperature Coefficient of Tuning Frequency $f_{TC}=0\pm 60\text{ppm}$ MITSUMI