

## BSP 89

### SIPMOS® Small-Signal Transistor

- N channel
- Enhancement mode
- Logic Level
- $V_{GS(th)} = 0.8...2.0V$

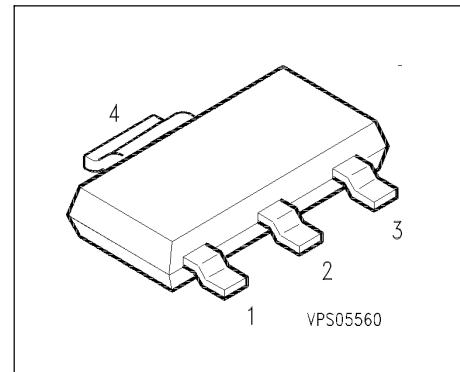

Pin 1	Pin 2	Pin 3	Pin 4
G	D	S	D

Type	$V_{DS}$	$I_D$	$R_{DS(on)}$	Package	Marking
BSP 89	240 V	0.36 A	6 $\Omega$	SOT-223	BSP 89
Type	Ordering Code		Tape and Reel Information		
BSP 89	Q67000-S652		E6327		

### Maximum Ratings

Parameter	Symbol	Values	Unit
Drain source voltage	$V_{DS}$	240	V
Drain-gate voltage	$V_{DGR}$	240	
$R_{GS} = 20 \text{ k}\Omega$			
Gate source voltage	$V_{GS}$	$\pm 20$	
ESD Sensitivity (HBM) as per MIL-STD 883		Class 1	
Continuous drain current	$I_D$	0.36	A
$T_A = 29 \text{ }^\circ\text{C}$			
DC drain current, pulsed	$I_{Dpuls}$	1.44	
$T_A = 25 \text{ }^\circ\text{C}$			
Power dissipation	$P_{tot}$	1.7	W
$T_A = 25 \text{ }^\circ\text{C}$			

**Maximum Ratings**

Parameter	Symbol	Values	Unit
Chip or operating temperature	$T_j$	-55 ... + 150	°C
Storage temperature	$T_{stg}$	-55 ... + 150	
Thermal resistance, chip to ambient air	$R_{thJA}$	≤ 72	K/W
Thermal resistance, junction-soldering point <sup>1)</sup>	$R_{thJS}$	≤ 12	
DIN humidity category, DIN 40 040		E	
IEC climatic category, DIN IEC 68-1		55 / 150 / 56	

1) Transistor on epoxy pcb 40 mm x 40 mm x 1,5 mm with 6 cm<sup>2</sup> copper area for drain connection

**Electrical Characteristics, at  $T_j = 25^\circ\text{C}$ , unless otherwise specified**

Parameter	Symbol	Values			Unit
		min.	typ.	max.	

**Static Characteristics**

Drain- source breakdown voltage $V_{GS} = 0\text{ V}, I_D = 0.25\text{ mA}, T_j = 25^\circ\text{C}$	$V_{(BR)DSS}$	240	-	-	V
Gate threshold voltage $V_{GS}=V_{DS}, I_D = 1\text{ mA}$	$V_{GS(th)}$	0.8	1.5	2	
Zero gate voltage drain current $V_{DS} = 240\text{ V}, V_{GS} = 0\text{ V}, T_j = 25^\circ\text{C}$ $V_{DS} = 240\text{ V}, V_{GS} = 0\text{ V}, T_j = 125^\circ\text{C}$ $V_{DS} = 60\text{ V}, V_{GS} = 0\text{ V}, T_j = 25^\circ\text{C}$	$I_{DSS}$	-	0.1 10 -	1 100 0.2	μA
Gate-source leakage current $V_{GS} = 20\text{ V}, V_{DS} = 0\text{ V}$	$I_{GSS}$	-	10	100	
Drain-Source on-state resistance $V_{GS} = 10\text{ V}, I_D = 0.36\text{ A}$ $V_{GS} = 4.5\text{ V}, I_D = 0.36\text{ A}$	$R_{DS(on)}$	-	3.5 4	6 10	Ω

**Electrical Characteristics, at  $T_j = 25^\circ\text{C}$ , unless otherwise specified**

Parameter	Symbol	Values			Unit
		min.	typ.	max.	
<b>Dynamic Characteristics</b>					
Transconductance $V_{DS} \geq 2 * I_D * R_{DS(on)max}$ , $I_D = 0.36\text{ A}$	$g_{fs}$	0.14	0.36	-	S
Input capacitance $V_{GS} = 0\text{ V}$ , $V_{DS} = 25\text{ V}$ , $f = 1\text{ MHz}$	$C_{iss}$	-	80	110	pF
Output capacitance $V_{GS} = 0\text{ V}$ , $V_{DS} = 25\text{ V}$ , $f = 1\text{ MHz}$	$C_{oss}$	-	15	25	
Reverse transfer capacitance $V_{GS} = 0\text{ V}$ , $V_{DS} = 25\text{ V}$ , $f = 1\text{ MHz}$	$C_{rss}$	-	8	12	
Turn-on delay time $V_{DD} = 30\text{ V}$ , $V_{GS} = 10\text{ V}$ , $I_D = 0.28\text{ A}$ $R_{GS} = 50\ \Omega$	$t_{d(on)}$	-	5	8	ns
Rise time $V_{DD} = 30\text{ V}$ , $V_{GS} = 10\text{ V}$ , $I_D = 0.28\text{ A}$ $R_{GS} = 50\ \Omega$	$t_r$	-	10	15	
Turn-off delay time $V_{DD} = 30\text{ V}$ , $V_{GS} = 10\text{ V}$ , $I_D = 0.28\text{ A}$ $R_{GS} = 50\ \Omega$	$t_{d(off)}$	-	30	40	
Fall time $V_{DD} = 30\text{ V}$ , $V_{GS} = 10\text{ V}$ , $I_D = 0.28\text{ A}$ $R_{GS} = 50\ \Omega$	$t_f$	-	20	27	

**Electrical Characteristics, at  $T_j = 25^\circ\text{C}$ , unless otherwise specified**

Parameter	Symbol	Values			Unit
		min.	typ.	max.	

**Reverse Diode**

Inverse diode continuous forward current $T_A = 25^\circ\text{C}$	$I_S$	-	-	0.36	A
Inverse diode direct current,pulsed $T_A = 25^\circ\text{C}$	$I_{SM}$	-	-	1.44	
Inverse diode forward voltage $V_{GS} = 0\text{ V}, I_F = 0.72\text{ A}, T_j = 25^\circ\text{C}$	$V_{SD}$	-	1.1	1.4	V

**Power dissipation**

$P_{tot} = f(T_A)$

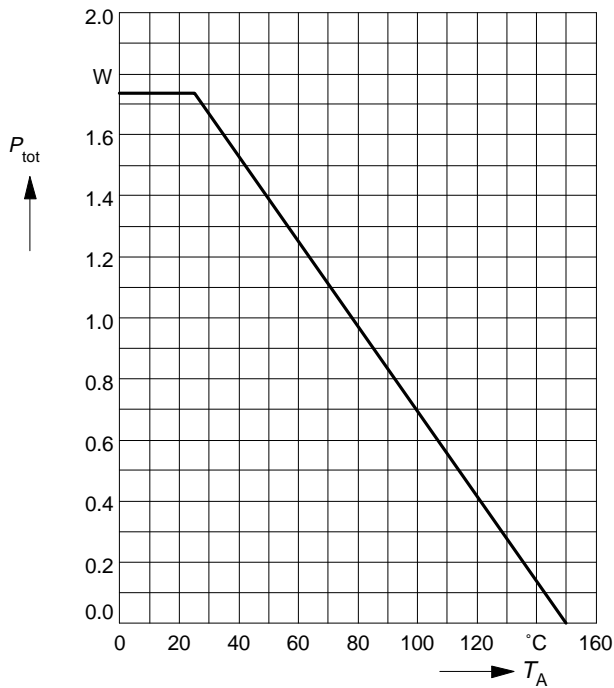

**Drain current**

$I_D = f(T_A)$

parameter:  $V_{GS} \geq 10\text{ V}$

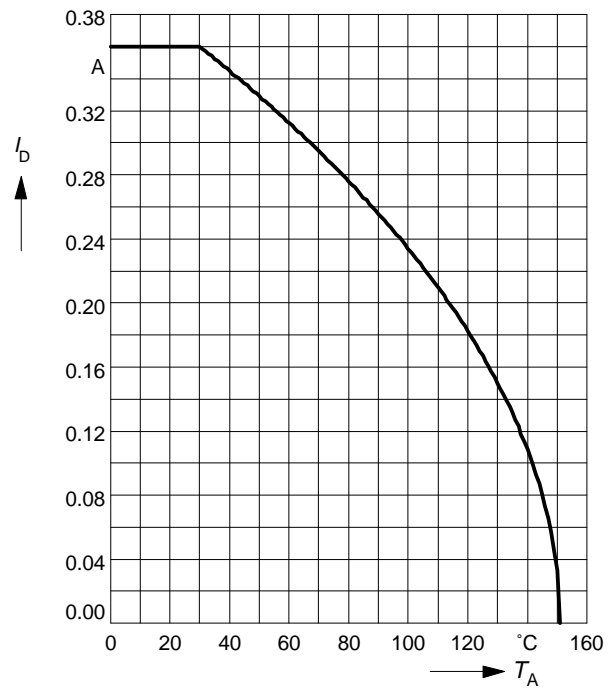

**Safe operating area  $I_D = f(V_{DS})$**

parameter :  $D = 0, T_C = 25^\circ\text{C}$

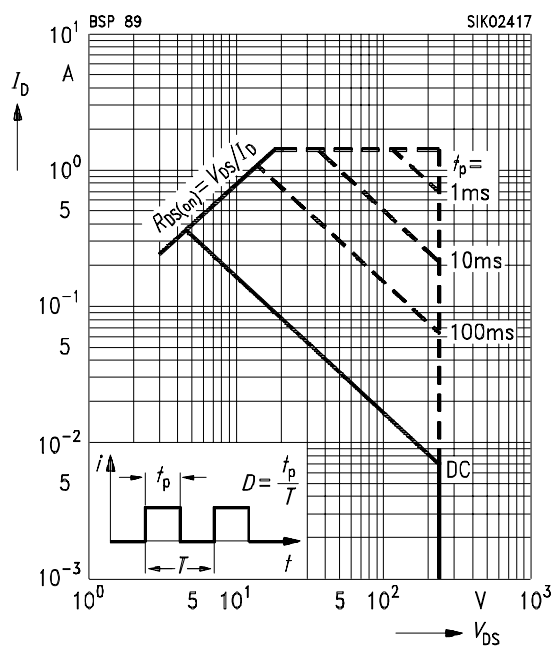

**Transient thermal impedance**

$Z_{thJA} = f(t_p)$

parameter:  $D = t_p / T$

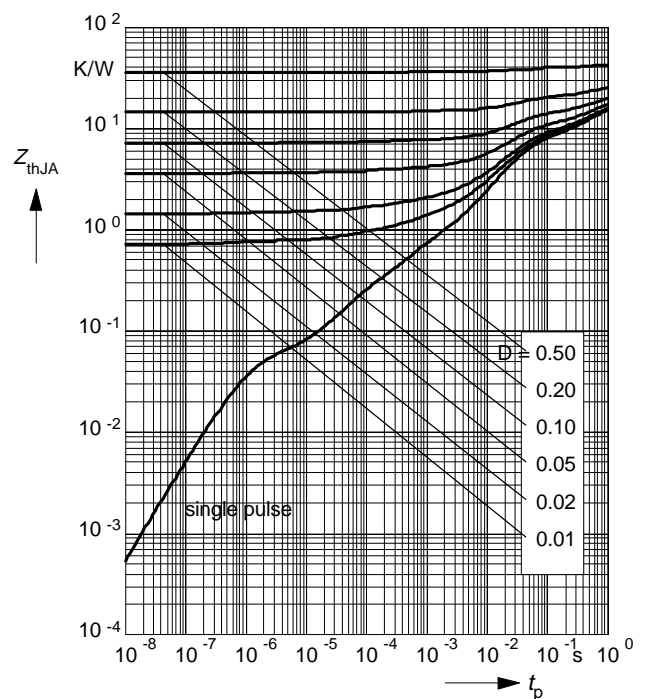

**Typ. output characteristics**

$I_D = f(V_{DS})$

parameter:  $t_p = 80 \mu s$

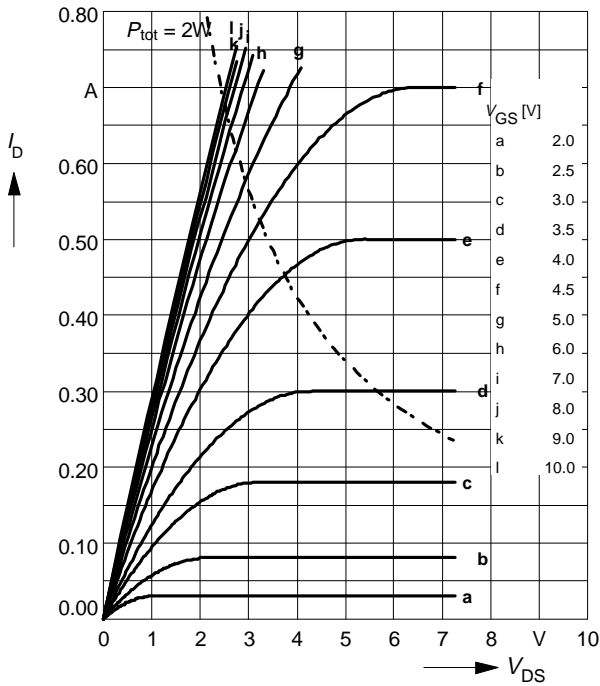

**Typ. drain-source on-resistance**

$R_{DS(on)} = f(I_D)$

parameter:  $t_p = 80 \mu s, T_j = 25^\circ C$

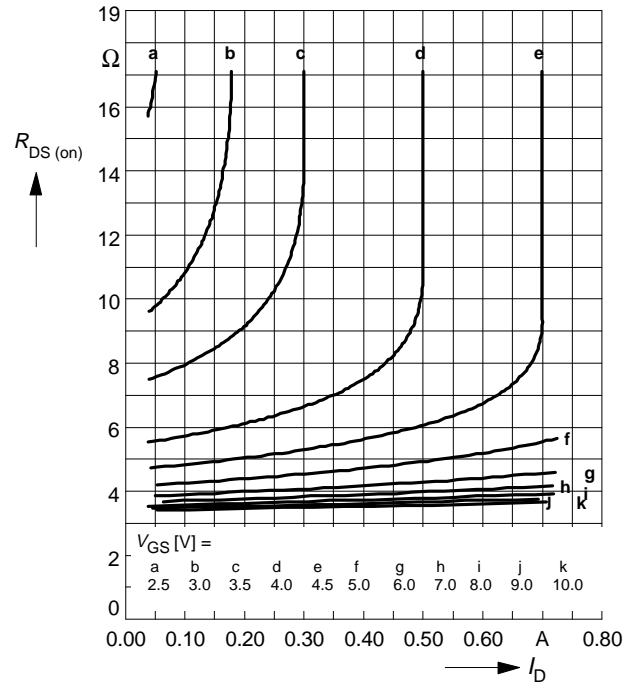

**Typ. transfer characteristics  $I_D = f(V_{GS})$**

parameter:  $t_p = 80 \mu s$

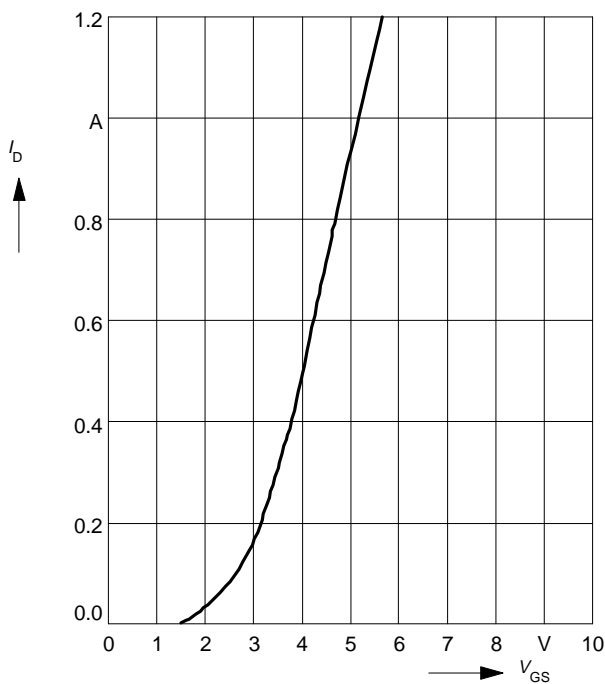

**Typ. forward transconductance  $g_{fs} = f(I_D)$**

parameter:  $t_p = 80 \mu s,$

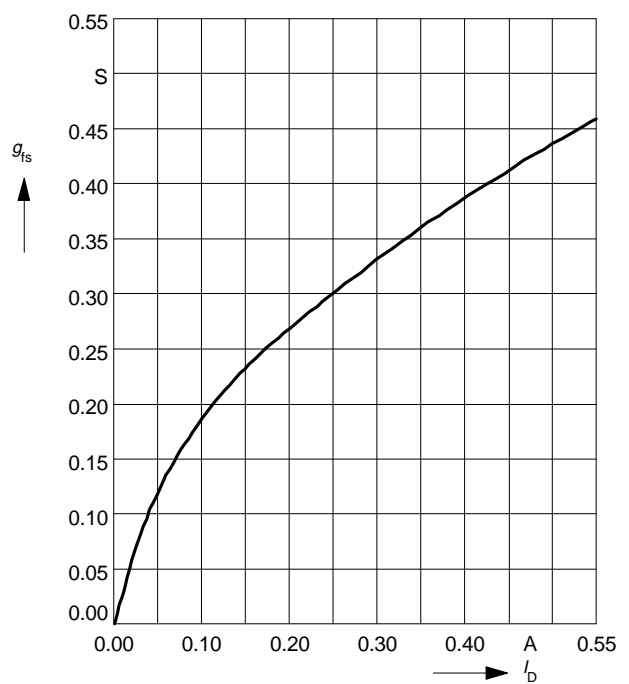

**Drain-source on-resistance**

$$R_{DS(on)} = f(T_j)$$

parameter:  $I_D = 0.36\text{ A}$ ,  $V_{GS} = 10\text{ V}$

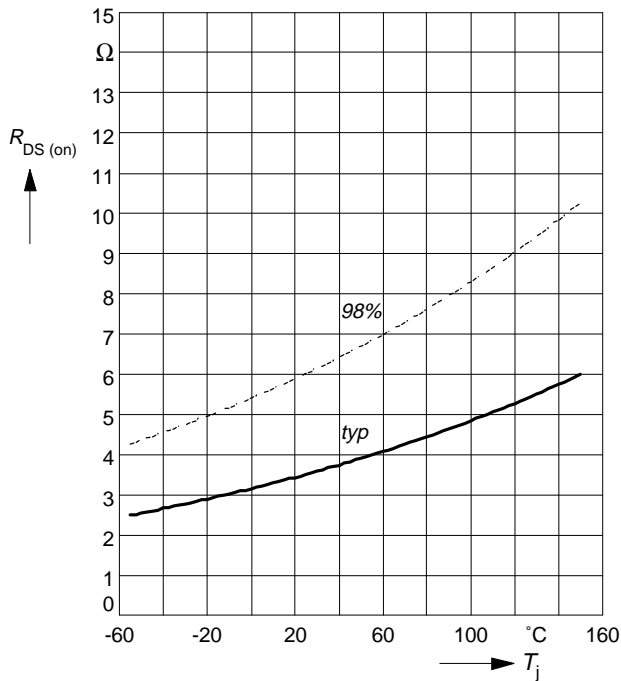

**Gate threshold voltage**

$$V_{GS(th)} = f(T_j)$$

parameter:  $V_{GS} = V_{DS}$ ,  $I_D = 1\text{ mA}$

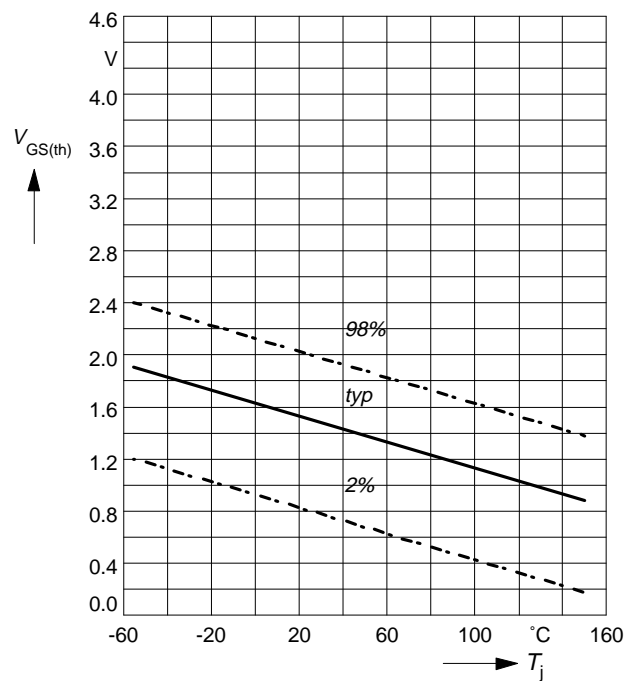

**Typ. capacitances**

$$C = f(V_{DS})$$

parameter:  $V_{GS} = 0\text{ V}$ ,  $f = 1\text{ MHz}$

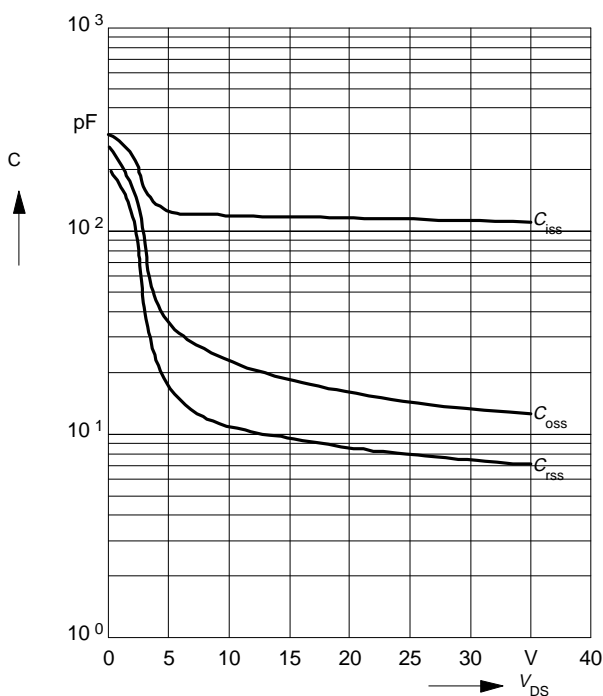

**Forward characteristics of reverse diode**

$$I_F = f(V_{SD})$$

parameter:  $T_j, t_p = 80\text{ }\mu\text{s}$

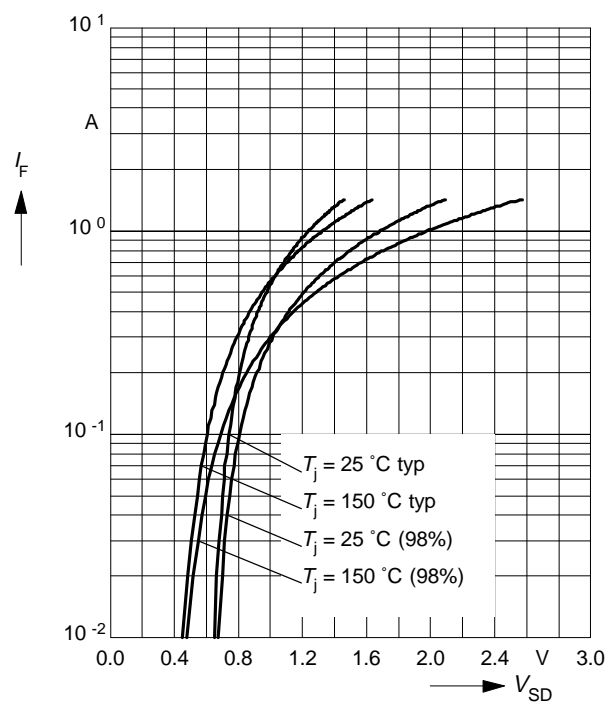

**Drain-source breakdown voltage**

$$V_{(BR)DSS} = f(T_j)$$

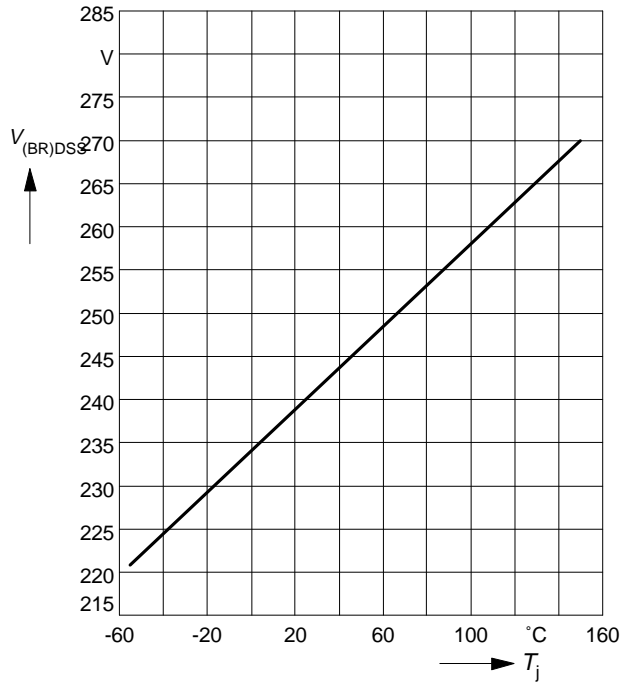

**Safe operating area  $I_D=f(V_{DS})$**

parameter :  $D = 0.01$ ,  $T_C = 25^\circ\text{C}$

