

## Optocoupler, Phototransistor Output, with Base Connection, High $BV_{CER}$ Voltage

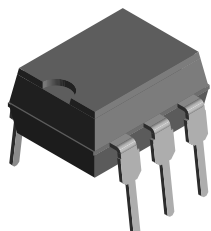

H179004

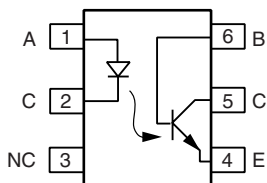

### DESCRIPTION

The H11D1, H11D2, H11D3, H11D4 are optocouplers with very high  $BV_{CER}$ . They are intended for telecommunications applications or any DC application requiring a high blocking voltage.

The H11D1, H11D2 are identical and the H11D3, H11D4 are identical.

### FEATURES

- CTR at  $I_F = 10 \text{ mA}$ ,  $BV_{CER} = 10 \text{ V}$ :  $\geq 20 \%$
- Good CTR linearly with forward current
- Low CTR degradation
- Very high collector emitter breakdown voltage
  - H11D1/H11D2,  $BV_{CER} = 300 \text{ V}$
  - H11D3/H11D4,  $BV_{CER} = 200 \text{ V}$
- Isolation test voltage:  $5300 \text{ V}_{RMS}$
- Low coupling capacitance
- High common mode transient immunity
- Package with base connection
- Lead (Pb)-free component
- Component in accordance to RoHS 2002/95/EC and WEEE 2002/96/EC



**RoHS**  
COMPLIANT

### AGENCY APPROVALS

- UL1577, file no. E52744 system code H or J, double protection
- DIN EN 60747-5-5 (VDE 0884) available with option 1
- BSI IEC 60950; IEC 60065
- FIMKO

### APPLICATIONS

- Telecommunications
- Replace relays

ORDER INFORMATION	
PART	REMARKS
H11D1	CTR > 20 %, DIP-6
H11D2	CTR > 20 %, DIP-6
H11D3	CTR > 20 %, DIP-6
H11D4	CTR > 20 %, DIP-6
H11D1-X007	CTR > 20 %, SMD-6 (option 7)
H11D1-X009	CTR > 20 %, SMD-6 (option 9)
H11D2-X007	CTR > 20 %, SMD-6 (option 7)
H11D3-X007	CTR > 20 %, SMD-6 (option 7)

#### Note

For additional information on the available options refer to option information.

ABSOLUTE MAXIMUM RATINGS					
PARAMETER	TEST CONDITION	PART	SYMBOL	VALUE	UNIT
<b>INPUT</b>					
Reverse voltage			$V_R$	6	V
DC forward current			$I_F$	60	mA
Surge forward current	$t \leq 10 \mu\text{s}$		$I_{FSM}$	2.5	A
Power dissipation			$P_{diss}$	100	mW



# H11D1, H11D2, H11D3, H11D4

Optocoupler, Phototransistor Output, with Base Connection, High  $BV_{CER}$  Voltage Vishay Semiconductors

ABSOLUTE MAXIMUM RATINGS					
PARAMETER	TEST CONDITION	PART	SYMBOL	VALUE	UNIT
<b>OUTPUT</b>					
Collector emitter voltage		H11D1	$V_{CE}$	300	V
		H11D2	$V_{CE}$	300	V
		H11D3	$V_{CE}$	200	V
		H11D4	$V_{CE}$	200	V
Collector base voltage		H11D1	$V_{CBO}$	300	V
		H11D2	$V_{CBO}$	300	V
		H11D3	$V_{CBO}$	200	V
		H11D4	$V_{CBO}$	200	V
Emitter base voltage			$V_{BEO}$	7	V
Collector current			$I_C$	100	mA
Power dissipation			$P_{diss}$	300	mW
<b>COUPLER</b>					
Isolation test voltage between emitter and detector			$V_{ISO}$	5300	$V_{RMS}$
Insulation thickness between emitter and detector				$\geq 0.4$	mm
Creepage distance				$\geq 7$	mm
Clearance distance				$\geq 7$	mm
Comparative tracking index	per DIN IEC 112/VDE 0303, part 1			175	
Isolation resistance	$V_{IO} = 500\text{ V}, T_{amb} = 25\text{ }^\circ\text{C}$		$R_{IO}$	$\geq 10^{12}$	$\Omega$
	$V_{IO} = 500\text{ V}, T_{amb} = 100\text{ }^\circ\text{C}$		$R_{IO}$	$\geq 10^{11}$	$\Omega$
Storage temperature range			$T_{stg}$	- 55 to + 150	$^\circ\text{C}$
Operating temperature range			$T_{amb}$	- 55 to + 100	$^\circ\text{C}$
Junction temperature			$T_j$	100	$^\circ\text{C}$
Soldering temperature	max. 10 s, dip soldering: distance to seating plane $\geq 1.5\text{ mm}$		$T_{sld}$	260	$^\circ\text{C}$

### Note

$T_{amb} = 25\text{ }^\circ\text{C}$ , unless otherwise specified.

Stresses in excess of the absolute maximum ratings can cause permanent damage to the device. Functional operation of the device is not implied at these or any other conditions in excess of those given in the operational sections of this document. Exposure to absolute maximum ratings for extended periods of the time can adversely affect reliability.

ELECTRICAL CHARACTERISTICS							
PARAMETER	TEST CONDITION	PART	SYMBOL	MIN.	TYP.	MAX.	UNIT
<b>INPUT</b>							
Forward voltage	$I_F = 10\text{ mA}$		$V_F$		1.1	1.5	V
Reverse voltage	$I_R = 10\text{ }\mu\text{A}$		$V_R$	6			V
Reverse current	$V_R = 6\text{ V}$		$I_R$		0.01	10	$\mu\text{A}$
Capacitance	$V_R = 0\text{ V}, f = 1\text{ MHz}$		$C_O$		25		pF
Thermal resistance			$R_{thJA}$		750		K/W

# H11D1, H11D2, H11D3, H11D4



Vishay Semiconductors Optocoupler, Phototransistor  
Output, with Base Connection,  
High  $BV_{CER}$  Voltage

ELECTRICAL CHARACTERISTICS								
PARAMETER	TEST CONDITION	PART	SYMBOL	MIN.	TYP.	MAX.	UNIT	
<b>OUTPUT</b>								
Collector emitter breakdown voltage	$I_{CE} = 1 \text{ mA}$ , $R_{BE} = 1 \text{ M}\Omega$	H11D1	$BV_{CER}$	300			V	
		H11D2	$BV_{CER}$	300			V	
		H11D3	$BV_{CER}$	200			V	
		H11D4	$BV_{CER}$	200			V	
Emitter base breakdown voltage	$I_{EB} = 100 \mu\text{A}$		$BV_{EBO}$	7			V	
Collector emitter capacitance	$V_{CE} = 10 \text{ V}$ , $f = 1 \text{ MHz}$		$C_{CE}$		7		pF	
Collector base capacitance	$V_{CB} = 10 \text{ V}$ , $f = 1 \text{ MHz}$		$C_{CB}$		8		pF	
Emitter base capacitance	$V_{EB} = 5 \text{ V}$ , $f = 1 \text{ MHz}$		$C_{EB}$		38		pF	
Thermal resistance			$R_{th}$		250		K/W	
<b>COUPLER</b>								
Coupling capacitance			$C_C$		0.6		pF	
Current transfer ratio	$I_F = 10 \text{ mA}$ , $V_{CE} = 10 \text{ V}$ , $R_{BE} = 1 \text{ M}\Omega$		$I_C/I_F$	20			%	
Collector emitter, saturation voltage	$I_F = 10 \text{ mA}$ , $I_C = 0.5 \text{ mA}$ , $R_{BE} = 1 \text{ M}\Omega$		$V_{CEsat}$		0.25	0.4	V	
Collector emitter, leakage current	$V_{CE} = 200 \text{ V}$ , $R_{BE} = 1 \text{ M}\Omega$	H11D1	$I_{CER}$			100	nA	
		H11D2	$I_{CER}$			100	nA	
	$V_{CE} = 300 \text{ V}$ , $R_{BE} = 1 \text{ M}\Omega$ , $T_{amb} = 100 \text{ }^\circ\text{C}$	H11D1	$I_{CER}$				250	$\mu\text{A}$
		H11D2	$I_{CER}$				250	$\mu\text{A}$

## Note

$T_{amb} = 25 \text{ }^\circ\text{C}$ , unless otherwise specified.

Minimum and maximum values were tested requirements. Typical values are characteristics of the device and are the result of engineering evaluations. Typical values are for information only and are not part of the testing requirements.

CURRENT TRANSFER RATIO							
PARAMETER	TEST CONDITION	PART	SYMBOL	MIN.	TYP.	MAX.	UNIT
Current transfer ratio	$I_F = 10 \text{ mA}$ , $V_{CE} = 10 \text{ V}$ , $R_{BE} = 1 \text{ M}\Omega$		CTR	20			%

SWITCHING CHARACTERISTICS							
PARAMETER	TEST CONDITION	SYMBOL	MIN.	TYP.	MAX.	UNIT	
Turn-on time	$I_C = 2 \text{ mA}$ (to be adjusted by varying $I_F$ ), $R_L = 100 \Omega$ , $V_{CC} = 10 \text{ V}$	$t_{on}$		5		$\mu\text{s}$	
Rise time	$I_C = 2 \text{ mA}$ (to be adjusted by varying $I_F$ ), $R_L = 100 \Omega$ , $V_{CC} = 10 \text{ V}$	$t_r$		2.5		$\mu\text{s}$	
Turn-off time	$I_C = 2 \text{ mA}$ (to be adjusted by varying $I_F$ ), $R_L = 100 \Omega$ , $V_{CC} = 10 \text{ V}$	$t_{off}$		6		$\mu\text{s}$	
Fall time	$I_C = 2 \text{ mA}$ (to be adjusted by varying $I_F$ ), $R_L = 100 \Omega$ , $V_{CC} = 10 \text{ V}$	$t_f$		5.5		$\mu\text{s}$	

## Note

Switching times measurement-test circuit and waveforms



## TYPICAL CHARACTERISTICS

$T_{amb} = 25\text{ }^{\circ}\text{C}$ , unless otherwise specified

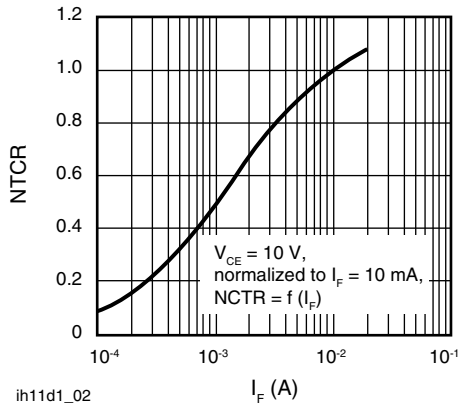

Fig. 1 - Current Transfer Ratio (typ.)

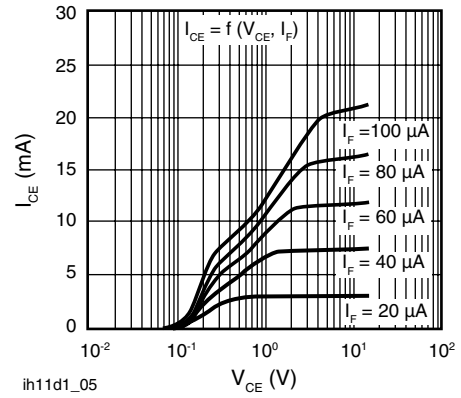

Fig. 4 - Output Characteristics

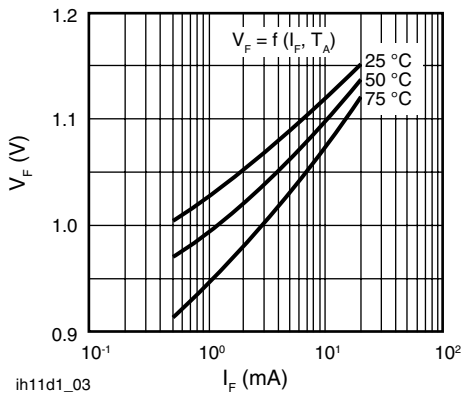

Fig. 2 - Diode Forward Voltage (typ.)

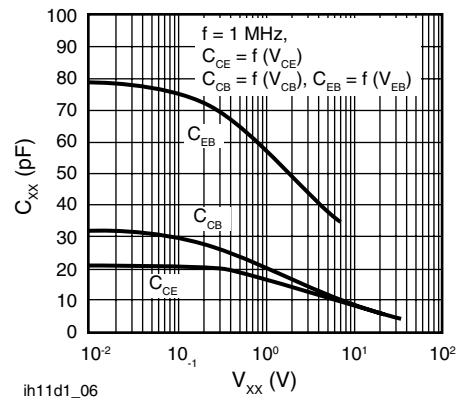

Fig. 5 - Transistor Capacitances (Typ.)

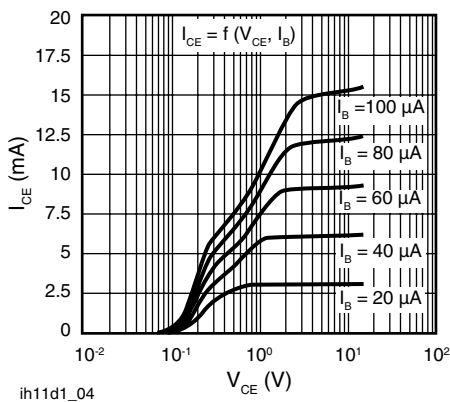

Fig. 3 - Output Characteristics

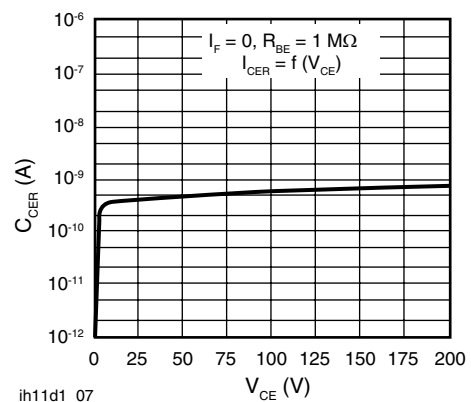
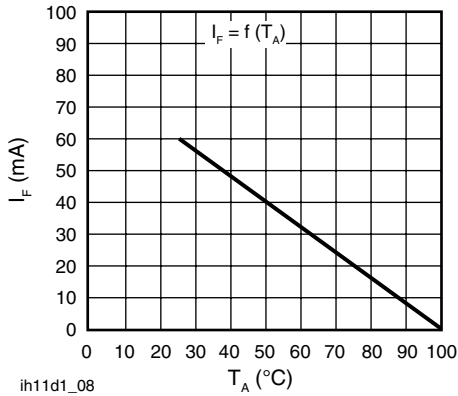

Fig. 6 - Collector Emitter Leakage Current (Typ.)

# H11D1, H11D2, H11D3, H11D4



Vishay Semiconductors Optocoupler, Phototransistor  
Output, with Base Connection,  
High  $V_{CER}$  Voltage



ih11d1\_08

Fig. 7 - Permissible Loss Diode

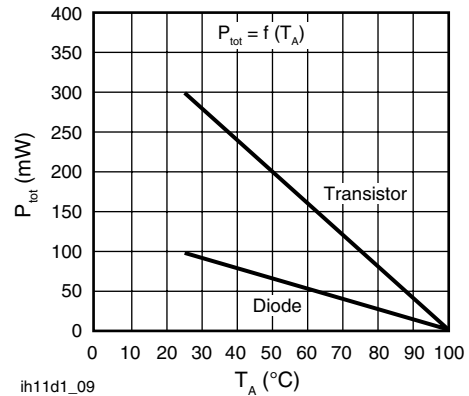

ih11d1\_09

Fig. 8 - Permissible Power Dissipation

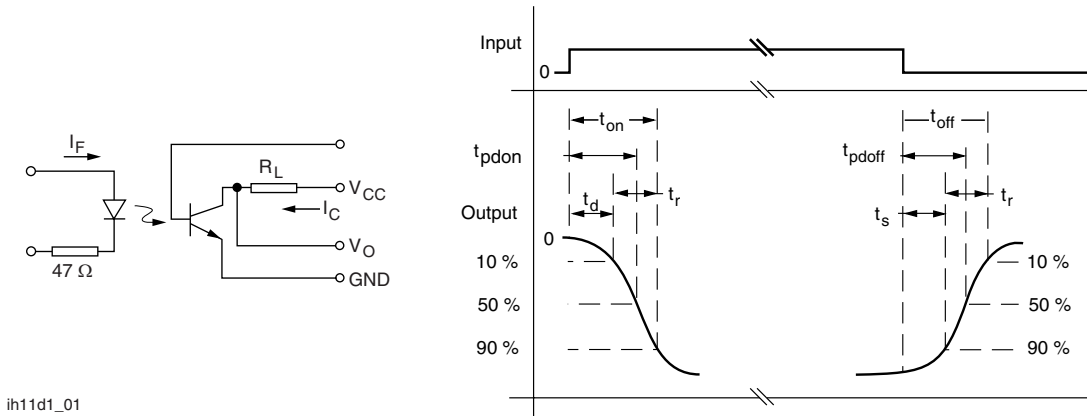

ih11d1\_01

Fig. 9 - Switching Times Measurement-Test Circuit and Waveform

## PACKAGE DIMENSIONS in inches (millimeters)

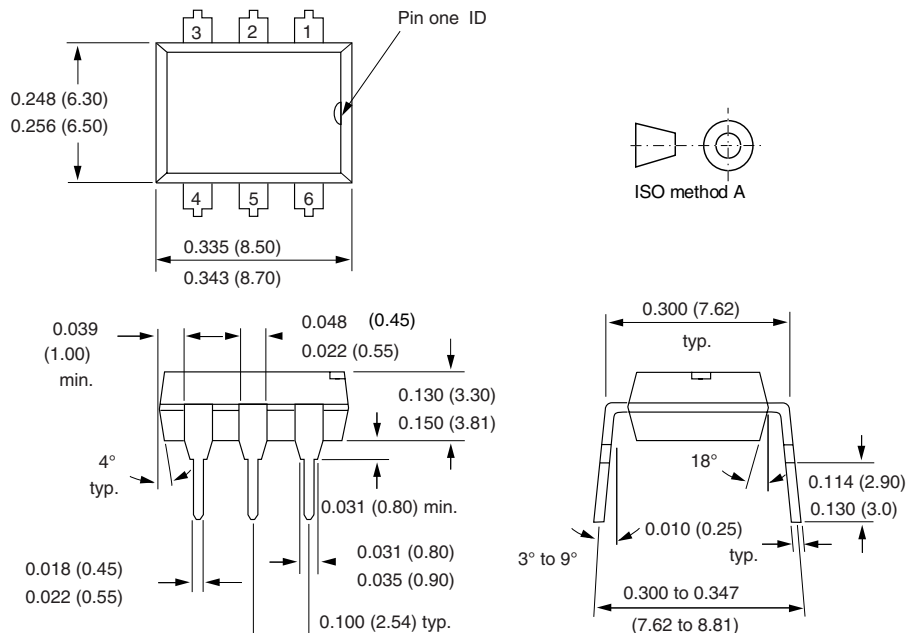

i178004



# H11D1, H11D2, H11D3, H11D4

Optocoupler, Phototransistor Output, with Base Connection,  
High  $BV_{CER}$  Voltage

**Option 7**

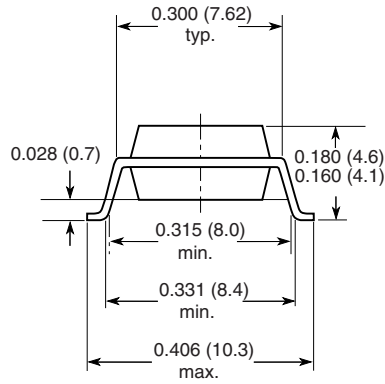

**Option 9**

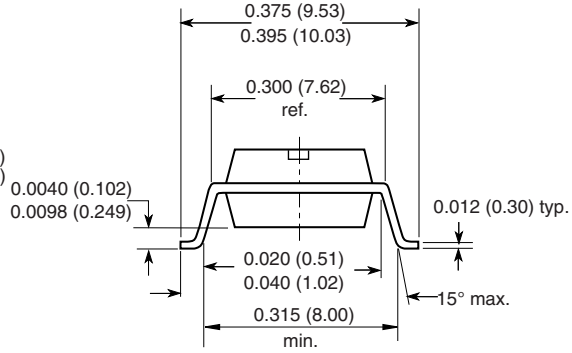

18494



Vishay Semiconductors    Optocoupler, Phototransistor  
Output, with Base Connection,  
High  $BV_{CER}$  Voltage

## **OZONE DEPLETING SUBSTANCES POLICY STATEMENT**

It is the policy of Vishay Semiconductor GmbH to

1. Meet all present and future national and international statutory requirements.
2. Regularly and continuously improve the performance of our products, processes, distribution and operating systems with respect to their impact on the health and safety of our employees and the public, as well as their impact on the environment.

It is particular concern to control or eliminate releases of those substances into the atmosphere which are known as ozone depleting substances (ODSs).

The Montreal Protocol (1987) and its London Amendments (1990) intend to severely restrict the use of ODSs and forbid their use within the next ten years. Various national and international initiatives are pressing for an earlier ban on these substances.

Vishay Semiconductor GmbH has been able to use its policy of continuous improvements to eliminate the use of ODSs listed in the following documents.

1. Annex A, B and list of transitional substances of the Montreal Protocol and the London Amendments respectively.
2. Class I and II ozone depleting substances in the Clean Air Act Amendments of 1990 by the Environmental Protection Agency (EPA) in the USA
3. Council Decision 88/540/EEC and 91/690/EEC Annex A, B and C (transitional substances) respectively.

Vishay Semiconductor GmbH can certify that our semiconductors are not manufactured with ozone depleting substances and do not contain such substances.

We reserve the right to make changes to improve technical design  
and may do so without further notice.

Parameters can vary in different applications. All operating parameters must be validated for each customer application by the customer. Should the buyer use Vishay Semiconductors products for any unintended or unauthorized application, the buyer shall indemnify Vishay Semiconductors against all claims, costs, damages, and expenses, arising out of, directly or indirectly, any claim of personal damage, injury or death associated with such unintended or unauthorized use.

Vishay Semiconductor GmbH, P.O.B. 3535, D-74025 Heilbronn, Germany



## Disclaimer

All product specifications and data are subject to change without notice.

Vishay Intertechnology, Inc., its affiliates, agents, and employees, and all persons acting on its or their behalf (collectively, "Vishay"), disclaim any and all liability for any errors, inaccuracies or incompleteness contained herein or in any other disclosure relating to any product.

Vishay disclaims any and all liability arising out of the use or application of any product described herein or of any information provided herein to the maximum extent permitted by law. The product specifications do not expand or otherwise modify Vishay's terms and conditions of purchase, including but not limited to the warranty expressed therein, which apply to these products.

No license, express or implied, by estoppel or otherwise, to any intellectual property rights is granted by this document or by any conduct of Vishay.

The products shown herein are not designed for use in medical, life-saving, or life-sustaining applications unless otherwise expressly indicated. Customers using or selling Vishay products not expressly indicated for use in such applications do so entirely at their own risk and agree to fully indemnify Vishay for any damages arising or resulting from such use or sale. Please contact authorized Vishay personnel to obtain written terms and conditions regarding products designed for such applications.

Product names and markings noted herein may be trademarks of their respective owners.