

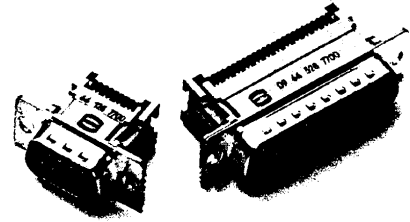

Number of contacts

9-37

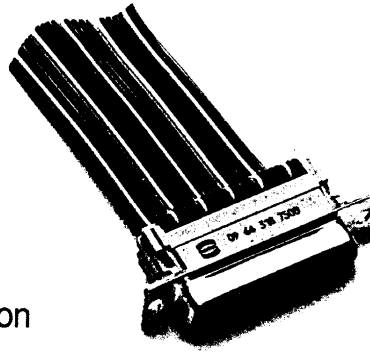

Insulation displacement termination

Identification	No. of contacts	Part No.
Performance levels Explanations page 6 Other contact surfaces on request		Performance level 3 Preferred types
Male connector – insulation displacement termination pitch 1.27 mm tinned metal shell and dimples	9 15 25 37	09 66 128 7700 09 66 228 7700 09 66 328 7700 09 66 428 7700
Female connector – insulation displacement termination pitch 1.27 mm tinned metal shell	9 15 25 37	09 66 118 7500 09 66 218 7500 09 66 318 7500 09 66 418 7500
Strain relief clamp corrosion resistant steel for male and female connectors	9 15 25 37	09 66 108 0000 09 66 208 0000 09 66 308 0000 09 66 408 0000
Performance level 2		09 66 128 6700 09 66 228 6700 09 66 328 6700 09 66 428 6700

Dimensions

Dimensions in mm

Male connector

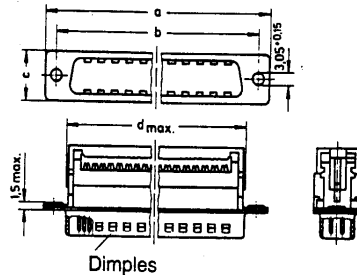

	a-076	b	c-076	d
9	31,19	25	12,93	18,6
15	39,52	33,3	12,93	26,9
25	53,42	47	12,93	40,6
37	69,7	63,5	12,93	57,1

Female connector

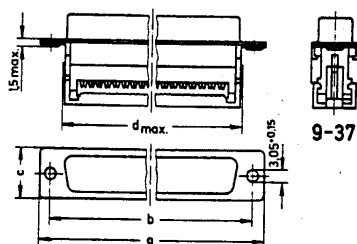

Specified conductors
 stranded wires AWG 28/7
 AWG 26/7
 solid wires AWG 30/1
 AWG 28/1

Strain relief clamp

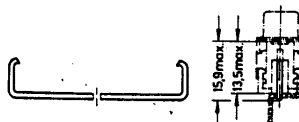

Technical characteristics



Number of contacts 9, 15, 25, 37, 50

Working current

see current carrying capacity chart
 Turned contacts 7.5 A max.
 Stamped contacts 6.5 A max.
 Insulation displacement 2 A max.

Test voltage $U_{r.m.s}$ 1 kV

Clearance and creepage ≥ 1.0 mm
 ≥ 0.7 mm (insulation displacement)

Contact resistance ≤ 10 m Ω

Insulation resistance $\geq 10^{10}$ Ω

Temperature range -55°C + 125°C

The higher temperature limit includes the local ambient and heating effect of the contacts under load

Terminations

- Solder buckets max. 0.5 mm²
- Solder pins \varnothing 0.6 mm for PC.B. holes \varnothing 0.8/1 mm
- Solder pins, angled 90° \varnothing 0.6 mm for PC.B. holes \varnothing 1 mm
- Wrap posts 0.6 x 0.6 mm diagonal 0.8-0.86 mm length 13 mm
- Crimp contacts 0.09-0.56 mm² AWG 28-20
- Insulation displacement AWG 28/7 and AWG 26/7 AWG 28/1 and AWG 30/1

Materials

Mouldings and hoods Thermoplastic resin, glass-fibre filled (PBTP) UL 94-VO

Contacts Copper alloy
 Contact versions
 Part No. 09 66 ...
 Male : solid
 Female : stamped
 Insulation displacement : stamped
 Part No. 09 67 ...
 Male and female : turned
 also stamped versions,
 for details see following pages

Contact surface¹⁾ Contact zone: selectively gold-plated according to performance level¹⁾
 Termination zone: tinned

Metal shell Steel
 Surface
 a) tinned
 b) zinc-plated and yellow chromated

Insertion and withdrawal force
 9 way ≥ 30 N
 15 way ≥ 50 N
 25 way ≥ 83 N
 37 way ≥ 123 N
 50 way ≥ 167 N

¹⁾ Performance Level 3 as per DIN 41 652, part 2
 ≥ 50 mating cycles
 no gas test

¹⁾ Performance Level 2 as per DIN 41 652, part 2
 ≥ 200 mating cycles
 4 day gas test using 10 ppm SO₂

Other contact surfaces on request

Current carrying capacity

The current carrying capacity is limited by maximum temperature of materials for inserts and contacts including terminals. The current capacity-curve is valid for continuous, not interrupted current-loaded contacts of connectors when simultaneous power on all contacts is given, without exceeding the maximum temperature.

Control and test procedures according to DIN 41 640, part 3.

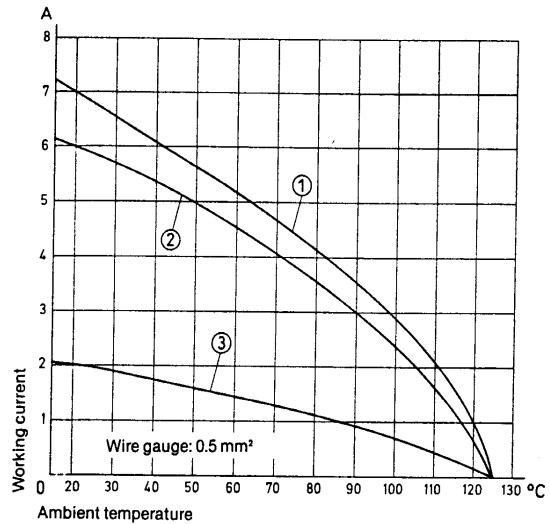

Example: 25 way connector

- Turned contacts
- Stamped contacts
- Insulation displacement contacts

Contact arrangement View from termination side

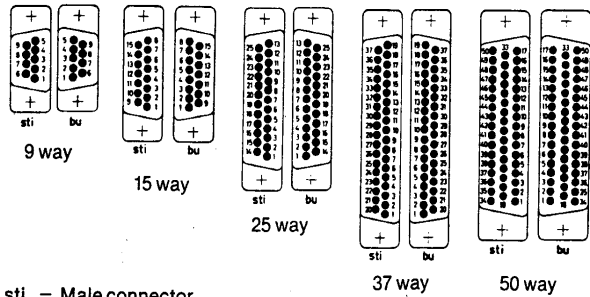

sti = Male connector
 bu = Female connector

Mating conditions as per DIN 41 652

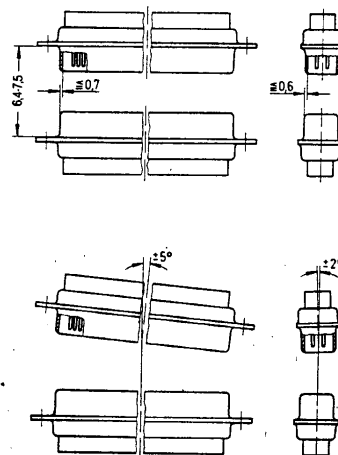



Identification

Drawing

Dimensions in mm

Low Profile Versions

Mounting height 3.6 mm
9-37 way
for front panel
3 units of width (TE)

Mounting height 6.2 mm
50 way
for front panel
4 units of width (TE)

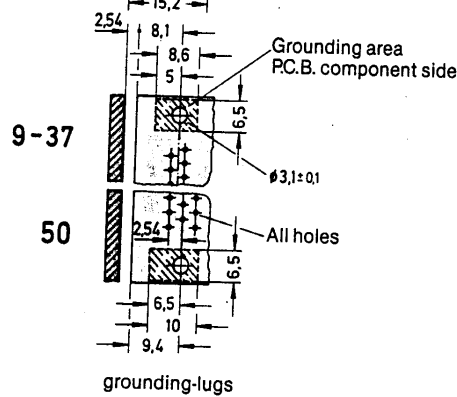
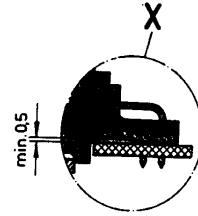
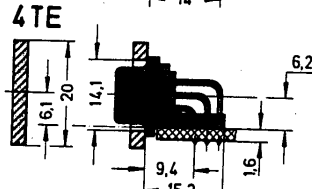
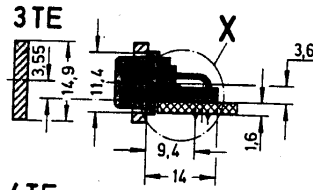

When flow soldering protect the mating face of the connector with adhesive tape e.g. Tesaband 4657 grey.

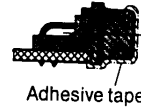

for connectors page 12-13

Standard Versions

Mounting height 7.3 mm
9-37 way
for front panel
4 units of width (TE)

Mounting height 8.7 mm
50 way
for front panel
5 units of width (TE)

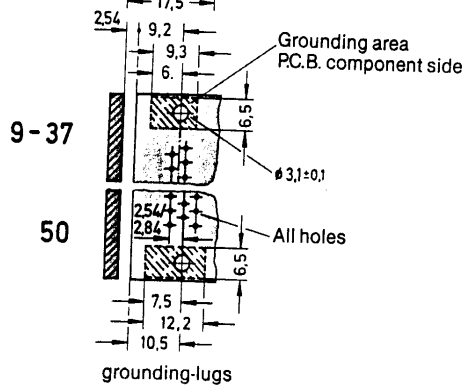
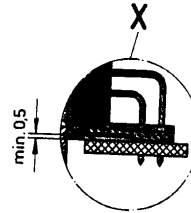
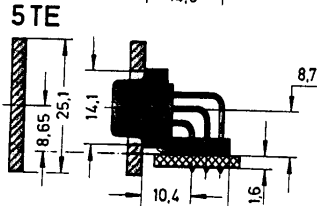
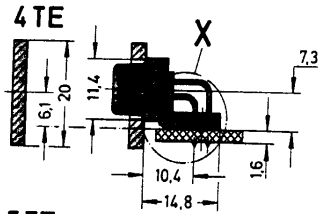

for connectors page 14-16

Panel cut out for front panel

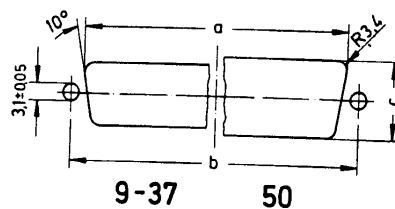

	a	b±0.1	c
9	20.5	25	11.4
15	28.8	33.3	11.4
25	42.5	47	11.4
37	59.1	63.5	11.4
50	56.3	61.1	14.1

Cables and tools

Identification	Part No. Preferred types	Dimensions in mm
----------------	-----------------------------	------------------

Flat cable

AWG 28/7

9 way	09 18 009 700
15 way	09 18 015 700
25 way	09 18 025 700
37 way	09 18 037 700

grey	30.48 m	3
grey	152.40 m	4
colourcoded	30.48 m	5

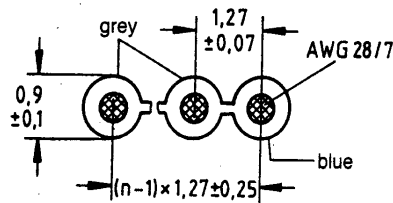

Wire (tinned) Cu
 Gauge AWG 28/7 0.089 mm²
 Insulation material PVC
 as per UL 2651

Important:
 always store reels vertically

Round flat cable

AWG 28/7

9 way	09 18 009 700
15 way	09 18 015 700
25 way	09 18 025 700
37 way	09 18 037 700

with screening	7
without screening	8

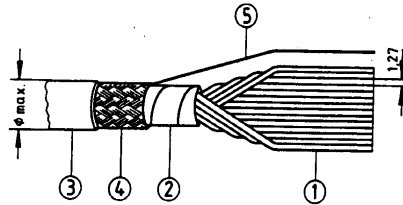

Part No.	No. of contacts*			
	Ø max.			
	9	15	25	37
09 18 ... 7007	8,3	9,1	10,2	11,2
09 18 ... 7008	7,7	8,6	9,7	10,6

*Others sizes on request

Length per reel 30.48 m (100 feet)

- ① Flat cable, grey AWG 28/7
- ② Barrier tape
- ③ Outer insulation PVC, grey
- ④ Tinned copper screen (shielded version)
- ⑤ Drain Wire AWG 28 (shielded version)

Cable cutter

for flat cables

09 99 000 0116

Spare parts

Blade

09 99 000 0179

Cutting plate

09 99 000 0180

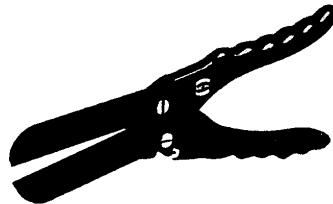

Bench press

for termination of insulation displacement connectors and assembly of hoods

09 99 000 0114

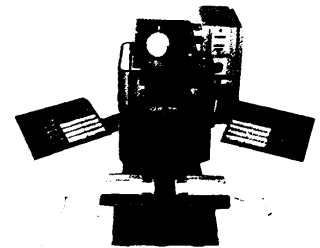

Harnessing work station and test equipment for flat cable assembly available on request.

Base plate

for termination of flat cables

09 99 000 0135

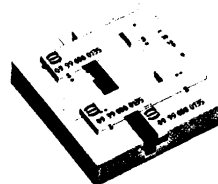

Hand tool with base plates

(included in tool kit)

for termination of insulation displacement connectors

09 99 000 0149

