

NEW

1.5, 1.8 & 2.5 Volt Models



Single Output A-Series, UWR Models

High-Density, 2" x 1"
1-6 Amp, 9-15 Watt DC/DC's

A-SERIES

Features

- 1.5/1.8/2.5V_{OUT} models source 6 Amps
- 3.3V_{OUT} models source 4.25 Amps
- 5/12/15V_{OUT} models deliver full 15 Watts
- 310kHz synchronous-rectifier topologies
- Guaranteed efficiencies to 86%
- Choice of 3 input voltage ranges:
10-18V, 18-36V, 36-75V
- -40 to +60/70°C ambient w/o derating
- Fully isolated (1500Vdc); I/O protected
- UL1950/EN60950 certified
- CE mark (75V_{IN} models)
- Standard 2" x 1" packages and pinouts
- Optional V_{OUT} trim, sync, on/off control
- Pin compatible with Lucent LC/LW Series

The new 1.5V, 1.8V and 2.5V models in DATEL's flagship 9-15 Watt A-Series can source a continuous 6 Amps. This is the most "low-voltage" current available from a standard 1" x 2" package, and these power converters exemplify DATEL's relentless drive to bring you more power/current, from standard packages, without compromising reliability or resorting to thermal specmanship.

By combining a high-frequency (310kHz), high-efficiency (to 88%), synchronous-rectifier topology with the newest components and time-tested, fully automated, SMT-on-pcb construction, these UWR Models are able to bring you 9-15W (@ up to 6A) in the standard 2" x 1" package from which most competitors can only get 5-10W (@ 3-4A). All UWR's deliver their full output power over ambient temperature ranges from -40°C to as high as +70°C (model and input voltage dependent) without heat sinks or supplemental forced-air cooling. Devices derate to +100°C.

Output voltages are 1.5, 1.8, 2.5, 3.3, 5, 12 or 15 Volts. Input voltage ranges are 10-18V ("D12" models), 18-36V ("D24" models) or 36-75V ("D48") models. All models feature input pi filters, input undervoltage and overvoltage lockout, input reverse-polarity protection, output overvoltage protection, output current limiting, and continuous short-circuit protection. On/off control, sync, and output-trim functions are optional (see Optional Functions). All models are certified to IEC950, UL1950 and EN60950 safety requirements for OPERATIONAL insulation. "D48" models (36-75V inputs) are CE marked.

UWR 9-15W DC/DC's are packaged in low-cost, light-weight, diallyl phthalate (UL94V-0 rated) plastic packages with standoffs. EMC compliance is achieved via a low-noise design rather than through expensive metal shielding.

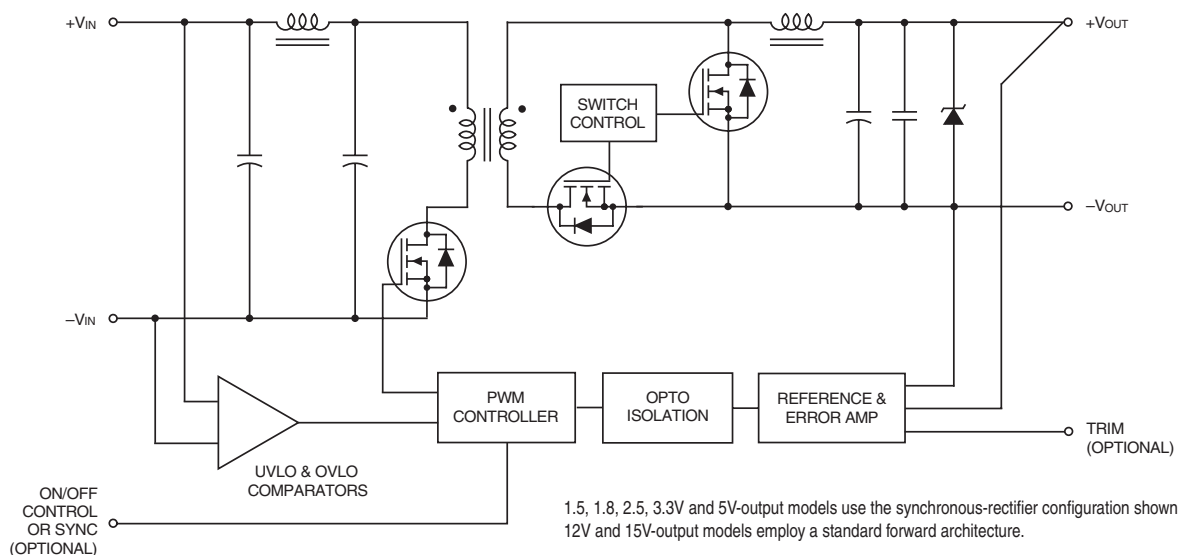

Figure 1. Simplified Schematic

Performance Specifications and Ordering Guide ①

Model	Output						Input			Efficiency		Package (Case, Pinout)
	V _{OUT} (Volts)	I _{OUT} (mA)	R/N (mVp-p) ②		Regulation (Max.)		V _{IN} Nom. (Volts)	Range (Volts)	I _{IN} ④ (mA)	Min.	Typ.	
			Typ.	Max.	Line	Load ③						
UWR-1.5/6000-D12A	1.5	6000	45	65	±0.2%	±0.3%	12	10-18	85/914	TBD	82%	C14, P22
UWR-1.5/6000-D24A	1.5	6000	45	65	±0.2%	±0.3%	24	18-36	50/454	TBD	82.5%	C14, P22
UWR-1.5/6000-D48A	1.5	6000	45	65	±0.2%	±0.3%	48	36-75	40/226	TBD	83%	C14, P22
UWR-1.8/6000-D12A	1.8	6000	50	70	±0.2%	±0.3%	12	10-18	85/1084	TBD	83%	C14, P22
UWR-1.8/6000-D24A	1.8	6000	50	70	±0.2%	±0.3%	24	18-36	50/539	TBD	83.5%	C14, P22
UWR-1.8/6000-D48A	1.8	6000	50	70	±0.2%	±0.3%	48	36-75	40/268	TBD	84%	C14, P22
UWR-2.5/6000-D12A	2.5	6000	60	80	±0.2%	±0.3%	12	10-18	80/1489	TBD	84%	C14, P22
UWR-2.5/6000-D24A	2.5	6000	60	80	±0.2%	±0.3%	24	18-36	45/740	TBD	84.5%	C14, P22
UWR-2.5/6000-D48A	2.5	6000	60	80	±0.2%	±0.3%	48	36-75	35/367	TBD	85%	C14, P22
UWR-3.3/4250-D12A	3.3	4250	85	100	±0.2%	±0.5%	12	10-18	80/1375	83%	85%	C14, P22
UWR-3.3/4250-D24A	3.3	4250	85	100	±0.2%	±0.5%	24	18-36	45/672	84.5%	87%	C14, P22
UWR-3.3/4250-D48A	3.3	4250	85	100	±0.2%	±0.5%	48	36-75	35/336	85%	87%	C14, P22
UWR-5/3000-D12A	5	3000	85	100	±0.2%	±0.3%	12	10-18	110/1471	83%	85%	C14, P22
UWR-5/3000-D24A	5	3000	85	100	±0.2%	±0.3%	24	18-36	55/710	85.5%	88%	C14, P22
UWR-5/3000-D48A	5	3000	85	100	±0.2%	±0.3%	48	36-75	35/355	85.5%	88%	C14, P22
UWR-12/1250-D12A	12	1250	85	100	±0.2%	±0.3%	12	10-18	20/1471	82.5%	85%	C14, P22
UWR-12/1250-D24A	12	1250	85	100	±0.2%	±0.3%	24	18-36	20/718	85%	87%	C14, P22
UWR-12/1250-D48A	12	1250	85	100	±0.2%	±0.3%	48	36-75	20/359	85%	87%	C14, P22
UWR-15/1000-D12A	15	1000	85	100	±0.2%	±0.3%	12	10-18	20/1471	82.5%	85%	C14, P22
UWR-15/1000-D24A	15	1000	85	100	±0.2%	±0.3%	24	18-36	20/718	85%	87%	C14, P22
UWR-15/1000-D48A	15	1000	85	100	±0.2%	±0.3%	48	36-75	20/359	85%	87%	C14, P22

PRELIMINARY

① Typical at T_A = +25°C under nominal line voltage and full-load conditions, unless otherwise noted.
 ② Ripple/Noise (R/N) is tested/specified over a 20MHz bandwidth. All models are specified with two external 0.47µF multi-layer ceramic capacitors installed across their output pins.

③ Load regulation is specified over 10%-100% load conditions. 1.5-5V models are stable and regulate under no-load conditions. 12/15V models have minimum loading requirements. See Performance/Functional Specifications.
 ④ Nominal line voltage, no-load/full-load conditions.

PART NUMBER STRUCTURE

UWR-5/3000-D48ACTLX

Output Configuration:
 U = Unipolar

Wide Range Input

Nominal Output Voltage:
 1.5, 1.8, 2.5, 3.3, 5, 12 or 15 Volts

Maximum Output Current
 in mA

Pin Length Option:
 L1 = 0.110"
 L2 = 0.145"

Optional Functions
 See Below

A-Series
 High Reliability

Input Voltage Range:
 D12 = 10-18 Volts (12V nominal)
 D24 = 18-36 Volts (24V nominal)
 D48 = 36-75 Volts (48V nominal)

Optional Functions

- T** Trim function on pin 5. No pin 3.
- C** On/Off Control function (positive polarity) on pin 3. No pin 5.
- CT** On/Off Control function (positive polarity) on pin 3. Trim function on pin 5.
- L1** Pin length: 0.110 in. (2.79mm) ±0.010
- L2** Pin length: 0.145 in. (3.68mm) ±0.010
- N** On/Off Control function (negative polarity) on pin 3. No pin 5.
- NT** On/Off Control function (negative polarity) on pin 3. Trim function on pin 5.
- S** Sync function on pin 3. No pin 5.
- ST** Sync function on pin 3. Trim function on pin 5.
- Blank** -- No Trim function. No On/Off Control function.

MECHANICAL SPECIFICATIONS

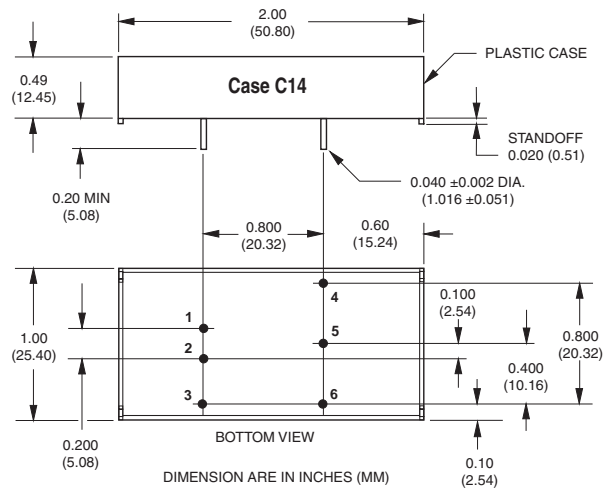

I/O Connections	
Pin	Function P22
1	+Input
2	-Input
3	On/Off Control*
4	+Output
5	Trim*
6	Common

* Pins 3 and 5 are optional. See Optional Functions and Technical Notes for details.

Performance/Functional Specifications

Typical @ T_A = +25°C under nominal line voltage and full-load conditions, unless noted. ① ②

Input	
Input Voltage Range:	
D12A Models	10-18 Volts (12V nominal)
D24A Models	18-36 Volts (24V nominal)
D48A Models	36-75 Volts (48V nominal)
Overvoltage Shutdown:	
D12A Models	18.5-21 Volts (20V typical)
D24A Models	37-40 Volts (38V typical)
D48A Models	77-81 Volts (78.5V typical)
Start-Up Threshold: ③	
D12A Models	9.4-9.8 Volts (9.6V typical)
D24A Models	16.5-18 Volts (17V typical)
D48A Models	34-36 Volts (35V typical)
Undervoltage Shutdown: ③	
D12A Models	7.5-8.5 Volts (8V typical)
D24A Models	16-17 Volts (16.5V typical)
D48A Models	32.5-35.5 Volts (34V typical)
Input Current:	
Normal Operating Conditions	See Ordering Guide
Standby Mode (Off, OV, UV)	5mA
Input Filter Type	Pi
Reverse-Polarity Protection	Brief duration, 10A maximum
On/Off Control (Optional, Pin 3): ④ ⑤	
D12AC, D24AC, & D48AC Models	On = open or 13V - +V _{IN} , I _{IN} = 50µA max. Off = 0-0.8V, I _{IN} = 1mA max.
D12AN, D24AN, & D48AN Models	On = 0-0.8V, I _{IN} = 2.6mA max. Off = open or 3.3-5.5V, I _{IN} = 1mA max.
Sync (Optional, Pin 3) ③ ④	
Input Threshold (Rising edge active)	1-2.7 Volts
Input Voltage Low	0-0.9 Volts
Input Voltage High	2.8-5 Volts
Input Resistance	35kΩ minimum
Output High Voltage (100µA load)	3.5-4.8 Volts
Output Drive Current	35mA
Input/Output Pulse Width	160-360nsec
Output	
V_{OUT} Accuracy (50% load):	
1.5V/1.8V/2.5V/3.3V Outputs	±1.5%, maximum
5/12/15V Outputs	±1%, maximum
Minimum Loading for Specification: ②	
1.5V/1.8V/2.5V/3.3V/5V Outputs	No load
12V/15V Outputs	10% of I _{OUT} max.
Minimum Loading for Stability: ②	
1.5V/1.8V/2.5V/3.3V/5V Outputs	No load
12V/15V Outputs	25mA
Ripple/Noise (20MHz BW) ① ⑥	See Ordering Guide
Line/Load Regulation	See Ordering Guide
Efficiency	See Ordering Guide
Isolation Voltage:	
Input-to-Output	1500Vdc minimum
Isolation Capacitance	470pF
Isolation Resistance	100MΩ
Current Limiting:	
1.5V/1.8V/2.5V/3.3V/5V Outputs	Hiccup technique, auto-recovery
12V/15V Outputs	Power-limiting technique, auto-recovery
Overvoltage Protection	Zener/transorb clamp, magnetic feedback
Temperature Coefficient	±0.04% per °C.

Dynamic Characteristics	
Transient Response (50% load step)	200µsec max. to ±1.5% of final value
Start-Up Time: ③	
V _{IN} to V _{OUT}	50msec
On/Off to V _{OUT}	30msec
Switching Frequency	310kHz (±30kHz)
Environmental	
Operating Temperature (Ambient):	
Without Derating ⑦	-40 to +60/70°C
With Derating	to +100°C (See Derating Curves)
Case Temperature:	
Maximum Allowable	+100°C
Storage Temperature	-40 to +105°C
Physical	
Dimensions	2" x 1" x 0.49" (51 x 25 x 12.45mm)
Shielding	None
Case Material	Diallyl phthalate, UL94V-0 rated
Pin Material	Brass, solder coated
Weight	1.4 ounces (39.7 grams)

- ① All models are specified with two external 0.47µF multi-layer ceramic capacitors installed across their output pins.
- ② See Minimum Output Loading Requirements under Technical Notes.
- ③ See Technical Notes for details.
- ④ The On/Off Control, Sync and Trim functions are optional and must be installed by DATEL. See Optional Functions or contact DATEL for details.
- ⑤ The On/Off Control is designed to be driven with open-collector logic or the application of appropriate voltages (referenced to -Input (Pin 2)). Applying a voltage to the On/Off Control pin when no input voltage is applied to the converter may cause permanent damage. See Technical Notes.
- ⑥ Output noise maybe further reduced with the addition of additional external output capacitors. See Technical Notes.
- ⑦ Operating temperature range without derating is model and input-voltage dependent. See Temperature Derating.

Absolute Maximum Ratings	
Input Voltage:	
Continuous:	
D12 Models	22 Volts
D24 Models	44 Volts
D48 Models	88 Volts
Transient (100msec):	
D12 Models	50 Volts
D24 Models	50 Volts
D48 Models	100 Volts
Input Reverse-Polarity Protection	Current must be <10 Amps. Brief duration only. Fusing recommended.
Output Overvoltage Protection:	
1.5/1.8V Outputs	TBD/TBD Volts, unlimited duration
2.5V/3.3V Outputs	TBD/4.5 Volts, unlimited duration
5V/12V/15V Outputs	6.8/15/18 Volts, unlimited duration
Output Current	Current limited. Devices can withstand sustained output short circuits without damage.
Case Temperature	+100°C
Storage Temperature	-40 to +105°C
Lead Temperature (soldering, 10 sec.)	+300°C
These are stress ratings. Exposure of devices to any of these conditions may adversely affect long-term reliability. Proper operation under conditions other than those listed in the Performance/Functional Specifications Table is not implied.	

TECHNICAL NOTES

Floating Outputs

Since these are isolated DC/DC converters, their outputs are "floating." Designers will usually use the output Common (pin 6) as the ground/return of the load circuit. You can, however, use the +Output (pin 4) as ground/return to effectively reverse the output polarity.

Minimum Output Loading Requirements

1.5-5V models employ a synchronous-rectifier design topology. All models regulate within spec and are stable under no-load conditions. 12/15V models employ a traditional forward architecture and require 10% loading (125mA for 12V models, 100mA for 15V models) to achieve their listed regulation specs. 12/15V models also have a minimum-load-for-stability requirement (25mA). For 12/15V models, operation between 25mA and 10% loading will result in stable operation but regulation may degrade. Operation under no-load conditions will not damage the 12/15V devices; however they may not meet all listed specifications.

Filtering and Noise Reduction

All A-Series UWR 9-15 Watt DC/DC Converters achieve their rated ripple and noise specifications using the external input and output capacitors specified in the Performance/Functional Specifications table. In critical applications, input/output noise may be further reduced by installing additional external I/O caps. Input capacitors should be selected for bulk capacitance, low ESR and high rms-ripple-current ratings. Output capacitors should be selected for low ESR and appropriate frequency response. All caps should have appropriate voltage ratings and be mounted as close to the converters as possible.

The most effective combination of external I/O capacitors will be a function of your particular load and layout conditions. Our Applications Engineers will be happy to recommend potential solutions and can discuss the possibility of our modifying a given device's internal filtering to meet your specific requirements. Contact our Applications Engineering Group for additional details.

Input Fusing

Certain applications and/or safety agencies may require the installation of fuses at the inputs of power conversion components. Fuses should also be used if the possibility of sustained, non-current-limited, input-voltage polarity reversals exists. For DATEL A-Series UWR 9-15 Watt DC/DC Converters, you should use slow-blow type fuses with values no greater than the following.

V _{IN} Range	Fuse Value
"D12A" Models	3 Amps
"D24A" Models	2 Amps
"D48A" Models	1 Amp

Trimming Output Voltages

These converters have a trim capability (pin 5) that allows users to adjust the output voltage ±5%. Adjustments to the output voltage can be accomplished via a trim pot, Figure 2, or a single fixed resistor as shown in Figures 3 and 4. A single fixed resistor can increase or decrease the output voltage depending on its connection. Fixed resistors should have an absolute TCR less than 100ppm/°C to minimize sensitivity to changes in temperature.

A single resistor connected from the Trim (pin 5) to the +Output (pin 4), see Figure 3, will decrease the output voltage. A resistor connected from the Trim (pin 5) to Output Common (pin 6) will increase the output voltage.

Trim adjustment greater than 5% can have an adverse effect on the converter's performance and is not recommended.

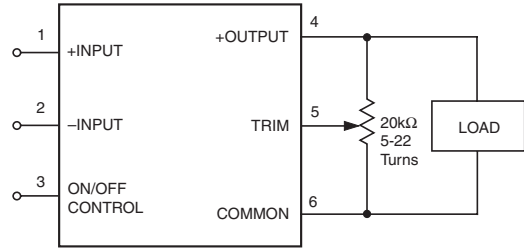

Figure 2. Trim Connections Using A Trim Pot

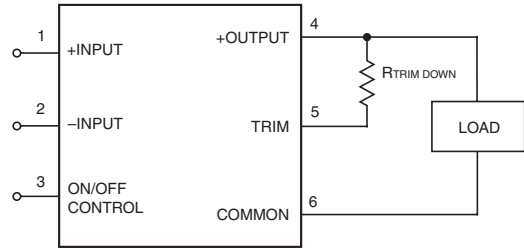

Figure 3. Trim Connections To Decrease Output Voltage Using Fixed Resistors

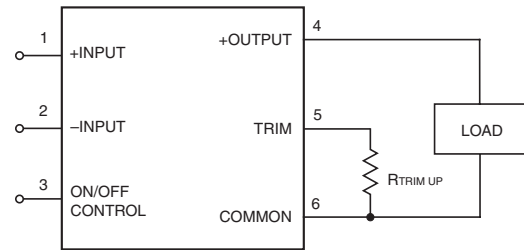

Figure 4. Trim Connections To Increase Output Voltage Using Fixed Resistors

Model	Trim Equation
UWR-3.3/4250-D12A UWR-3.3/4250-D24A UWR-3.3/4250-D48A	$R_{T_{DOWN}} (k\Omega) = \frac{2.49(V_O - 1.27)}{3.3 - V_O} - 16.9$ $R_{T_{UP}} (k\Omega) = \frac{3.16}{V_O - 3.3} - 16.9$
UWR-5/3000-D12A UWR-5/3000-D24A UWR-5/3000-D48A	$R_{T_{DOWN}} (k\Omega) = \frac{2.49(V_O - 2.527)}{5 - V_O} - 15$ $R_{T_{UP}} (k\Omega) = \frac{6.292}{V_O - 5} - 15$
UWR-12/1250-D12A UWR-12/1250-D24A UWR-12/1250-D48A	$R_{T_{DOWN}} (k\Omega) = \frac{6.34(V_O - 5.714)}{12 - V_O} - 49.9$ $R_{T_{UP}} (k\Omega) = \frac{36.23}{V_O - 12} - 49.9$
UWR-15/1000-D12A UWR-15/1000-D24A UWR-15/1000-D48A	$R_{T_{DOWN}} (k\Omega) = \frac{7.87(V_O - 7.136)}{15 - V_O} - 63.4$ $R_{T_{UP}} (k\Omega) = \frac{56.16}{V_O - 15} - 63.4$

Accuracy of adjustment is subject to tolerances or resistor values and factory-adjusted output accuracy. V_O = desired output voltage.

Start-Up Threshold and Undervoltage Shutdown

Under normal start-up conditions, devices will not begin to regulate until the ramping-up input voltage exceeds the Start-Up Threshold Voltage (35V for "D48A" models). Once operating, devices will not turn off until the input voltage drops below the Undervoltage Shutdown/Lockout limit (34V for "D48A" models). Subsequent re-start will not occur until the input is brought back up to the Start-Up Threshold. This built-in hysteresis obviously avoids any indeterminate on/off situations at a single voltage.

Start-Up Time

The V_{IN} to V_{OUT} Start-Up Time is the interval between the time at which a ramping input voltage crosses the turn-on threshold point and the fully-loaded output voltage enters and remains within its specified accuracy band. Actual measured times will vary with input source impedance, external input capacitance, and the slew rate and final value of the input voltage as it appears to the converter.

The On/Off to V_{OUT} Start-Up Time assumes the converter is turned off via the On/Off Control with the nominal input voltage already applied to the converter. The specification defines the interval between the time at which the converter is turned on and the fully-loaded output voltage enters and remains within its specified accuracy band.

TEMPERATURE DERATING

The thermal performance of A-Series UWR 15 Watt DC/DC Converters is depicted in the derating curves shown below. All devices, when operated at full load, in still ambient air, over their full specified input voltage range, can safely operate to +60°C. All models, other than the D12A models (10-18 Volt input range), can operate at higher ambient temperatures if the input range is narrowed. For example, model UWR-5/3000-D48A can operate safely to +70°C if the input range is kept between 36 and 48 Volts. Contact DATEL's Applications Engineering Group if you need additional details.

D24A Temperature Derating Curves for 5V, 12V and 15V Output Models

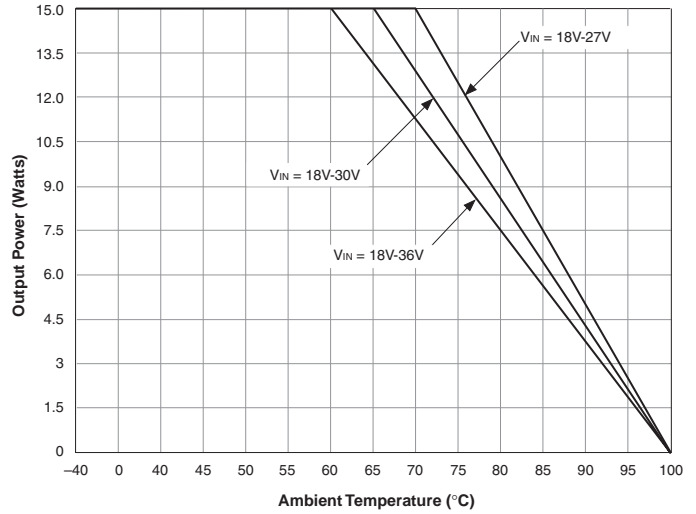

D24A and D48A Temperature Derating Curves for 3.3V Output Models

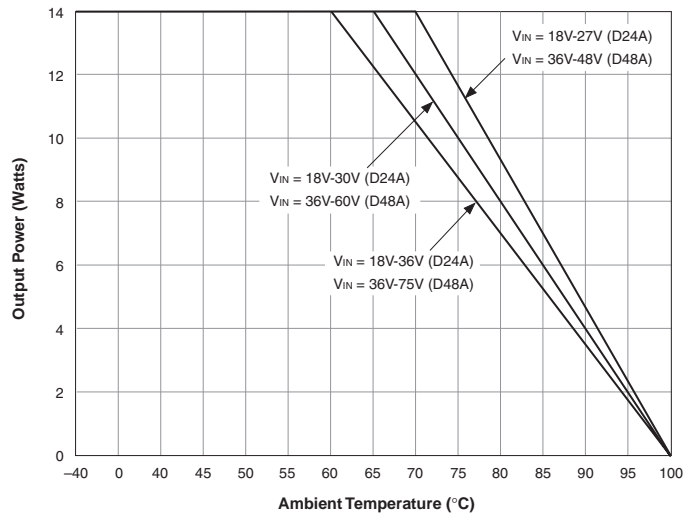

D12A (10-18V) Temperature Derating Curves

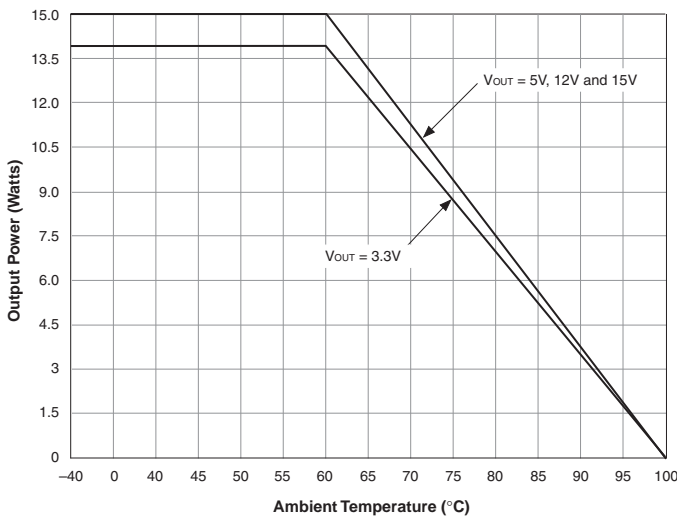

D48A Temperature Derating Curves for 5V, 12V and 15V Output Models

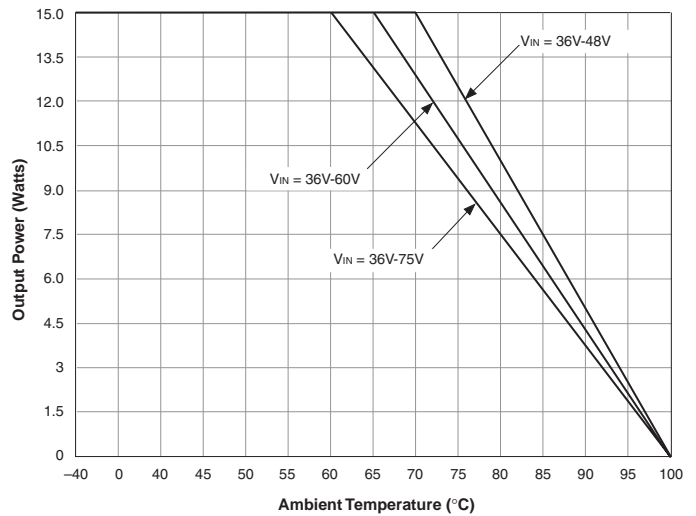

EFFICIENCY VS. LINE AND LOAD

UWR-3.3/4250-D12A Efficiency vs. Line and Load

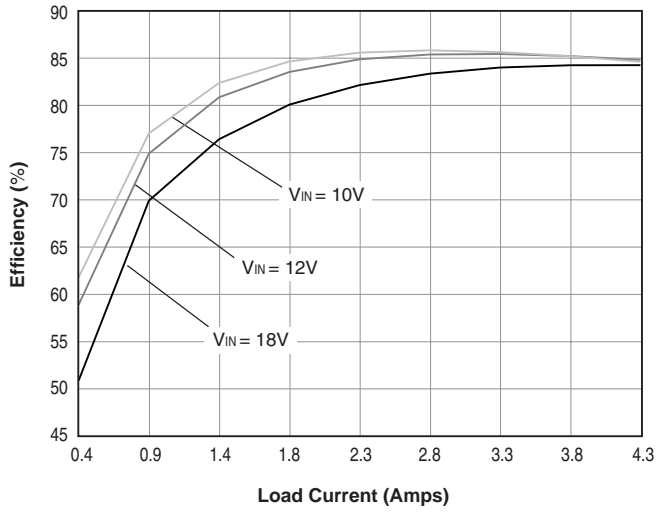

UWR-5/3000-D12A Efficiency vs. Line and Load

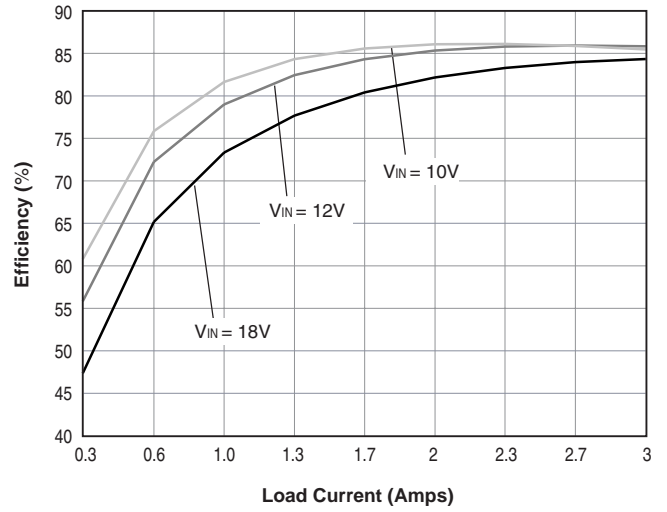

UWR-3.3/4250-D24A Efficiency vs. Line and Load

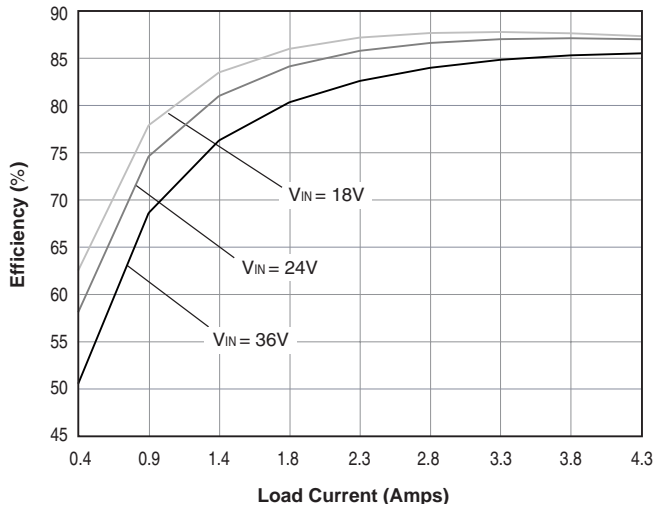

UWR-5/3000-D24A Efficiency vs. Line and Load

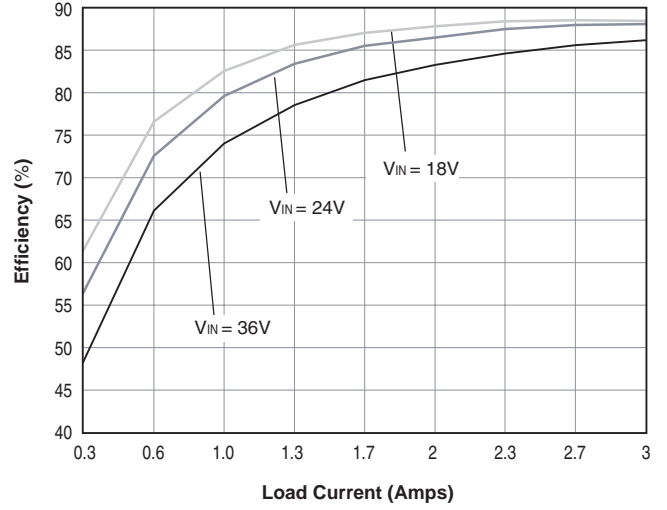

UWR-3.3/4250-D48A Efficiency vs. Line and Load

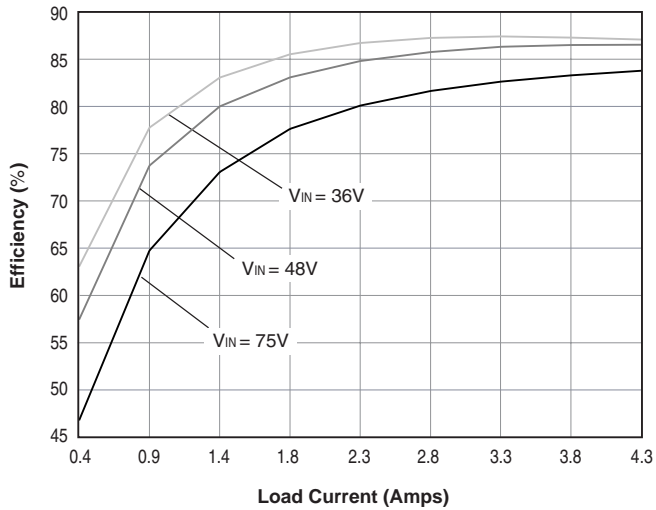

UWR-5/3000-D48A Efficiency vs. Line and Load

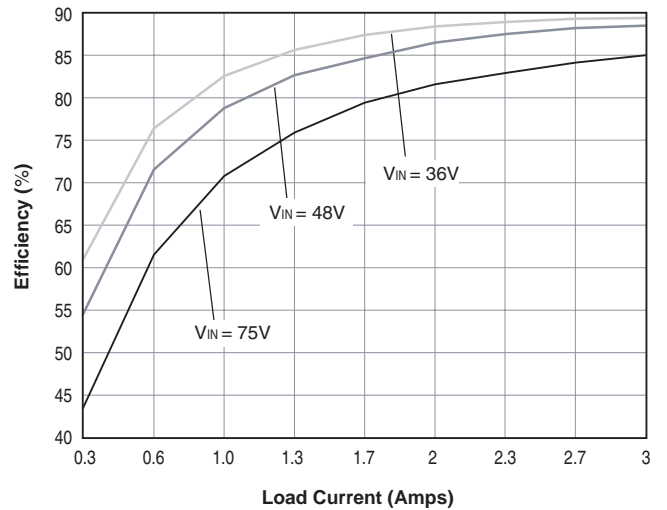

EFFICIENCY VS. LINE AND LOAD

UWR-12/1250-D12A Efficiency vs. Line and Load

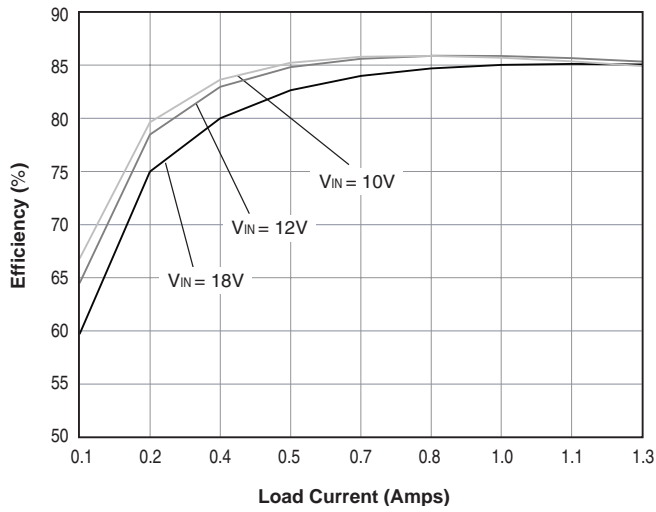

UWR-15/1000-D12A Efficiency vs. Line and Load

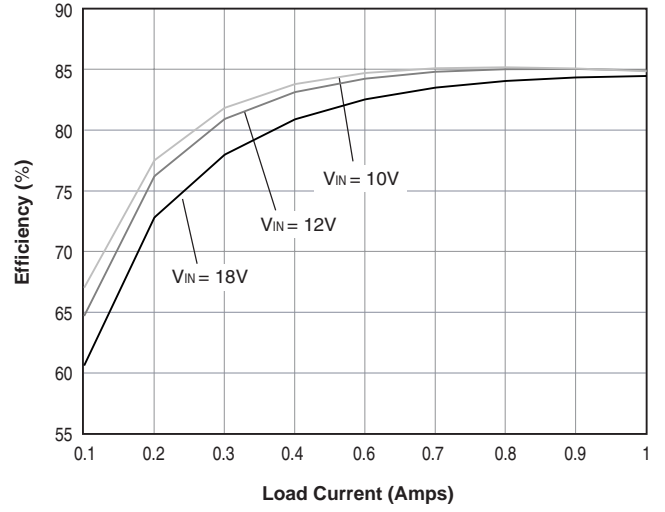

UWR-12/1250-D24A Efficiency vs. Line and Load

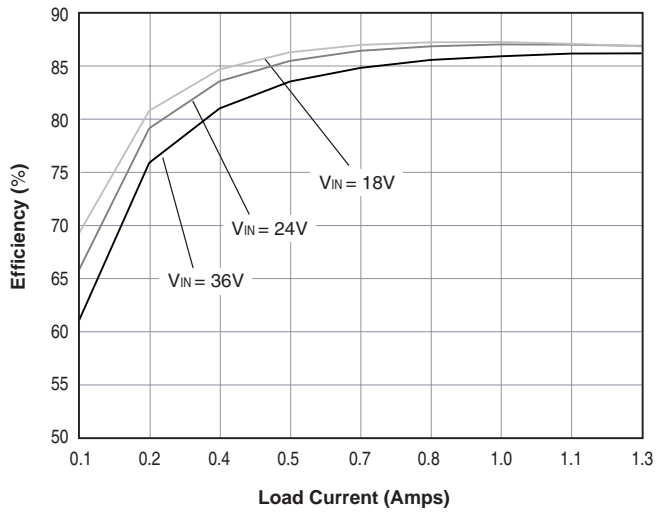

UWR-15/1000-D24A Efficiency vs. Line and Load

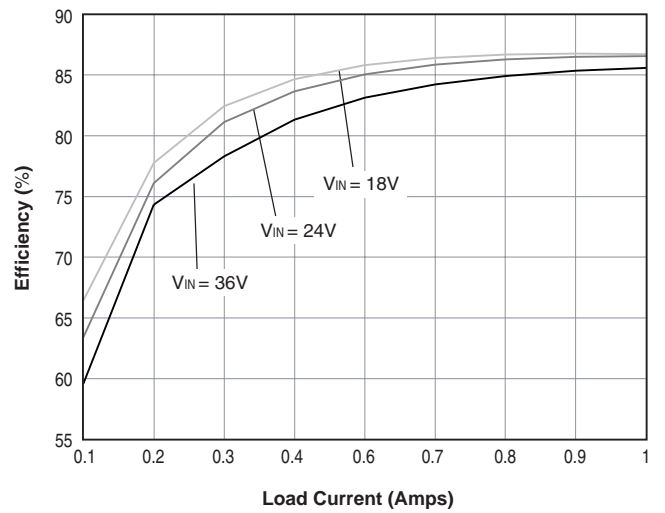

UWR-12/1250-D48A Efficiency vs. Line and Load

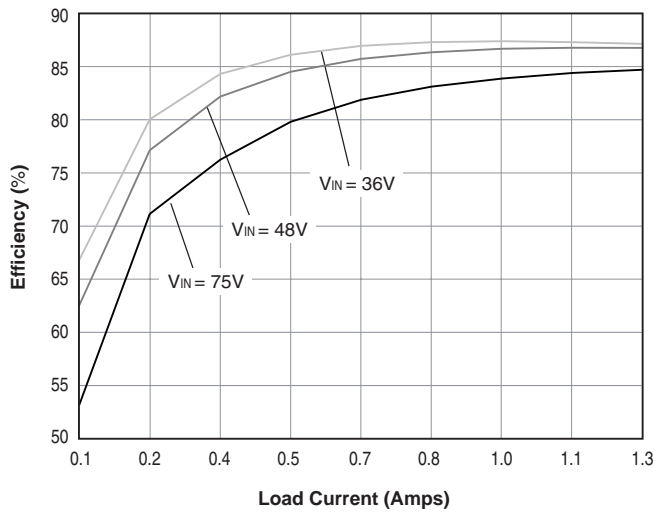

UWR-15/1000-D48A Efficiency vs. Line and Load

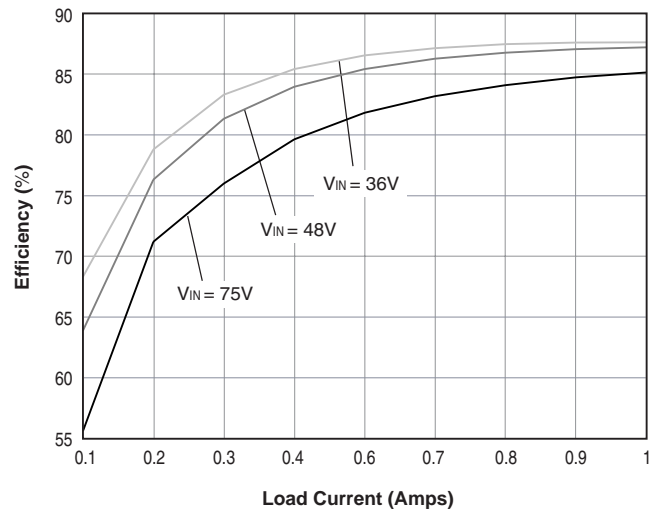

Typical Performance Curves

Output Ripple and Noise (PARD)

(VIN = nominal, 3.3V @ 4.25A, two external 0.47µF output capacitors.)

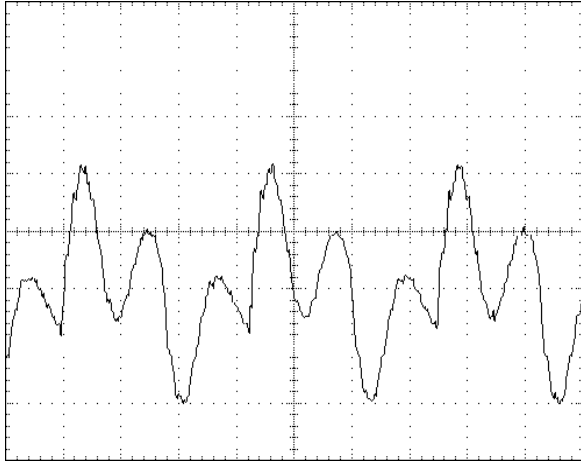

20mV/div, 20MHz BW

Output Ripple and Noise (PARD)

(VIN = nominal, 12V @ 1.25A, two external 0.47µF output capacitors.)

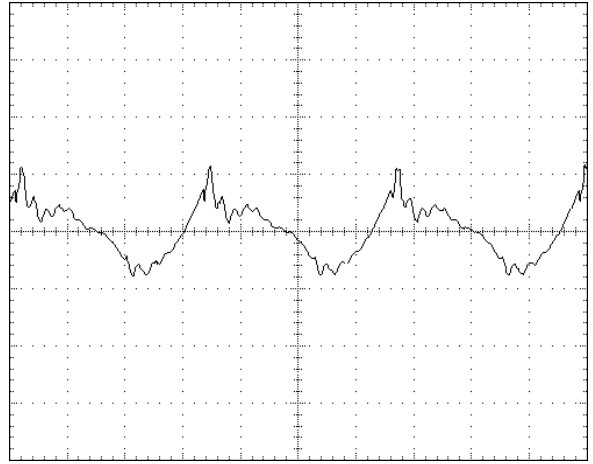

20mV/div, 20MHz BW

Output Ripple and Noise (PARD)

(VIN = nominal, 5V @ 3A, two external 0.47µF output capacitors.)

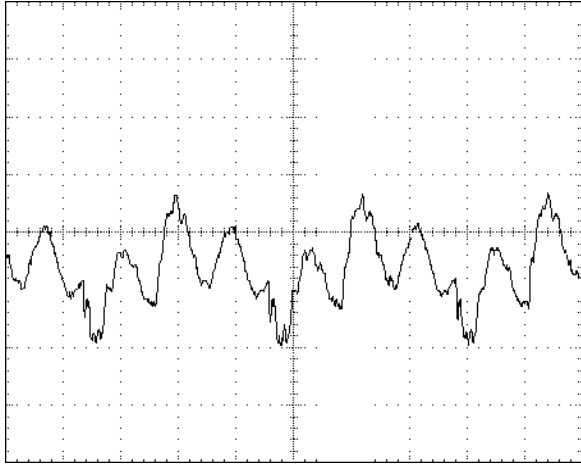

20mV/div, 20MHz BW

Output Ripple and Noise (PARD)

(VIN = nominal, 15V @ 1A, two external 0.47µF output capacitors.)

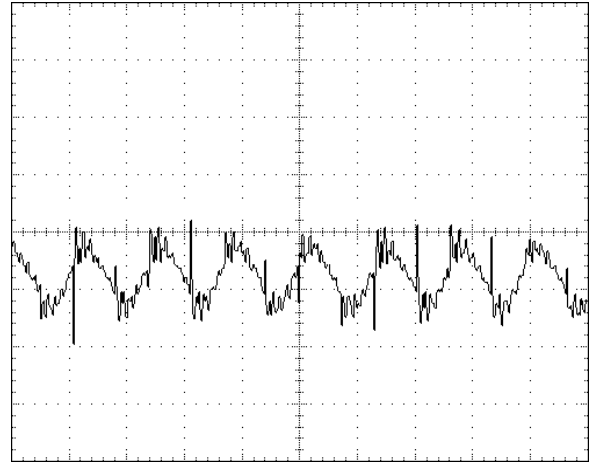

20mV/div, 20MHz BW



ISO-9001 REGISTERED

DS-0426B 9/01

DATEL, Inc. 11 Cabot Boulevard, Mansfield, MA 02048-1151
 Tel: (508) 339-3000 (800) 233-2765 Fax: (508) 339-6356
 Internet: www.datel.com Email: sales@datel.com
 Data Sheet Fax Back: (508) 261-2857

DATEL (UK) LTD. Tadley, England Tel: (01256)-880444
 DATEL S.A.R.L. Montigny Le Bretonneux, France Tel: 01-34-60-01-01
 DATEL GmbH München, Germany Tel: 89-544334-0
 DATEL KK Tokyo, Japan Tel: 3-3779-1031, Osaka Tel: 6-6354-2025

DATEL makes no representation that the use of its products in the circuits described herein, or the use of other technical information contained herein, will not infringe upon existing or future patent rights. The descriptions contained herein do not imply the granting of licenses to make, use, or sell equipment constructed in accordance therewith. Specifications are subject to change without notice. The DATEL logo is a registered DATEL, Inc. trademark.