

isc Silicon PNP Power Transistor

BD738

www.DataSheet4U.com

DESCRIPTION

- DC Current Gain -
: $h_{FE} = 40(\text{Min.}) @ I_C = -20\text{mA}$
- Collector-Emitter Breakdown Voltage-
: $V_{(BR)CEO} = -45\text{V}(\text{Min.})$
- Complement to Type BD737

APPLICATIONS

- Designed for amplifier and switching applications.

ABSOLUTE MAXIMUM RATINGS($T_a=25^\circ\text{C}$)

SYMBOL	PARAMETER	VALUE	UNIT
V_{CBO}	Collector-Base Voltage	-45	V
V_{CEO}	Collector-Emitter Voltage	-45	V
V_{EBO}	Emitter-Base Voltage	-5	V
I_C	Collector Current-Continuous	-4	A
I_{CM}	Collector Current-Peak	-7	A
I_B	Base Current-Continuous	-1	A
P_C	Collector Power Dissipation @ $T_a=25^\circ\text{C}$	2	W
	Collector Power Dissipation @ $T_C=25^\circ\text{C}$	40	
T_J	Junction Temperature	150	$^\circ\text{C}$
T_{stg}	Storage Temperature Range	-55~150	$^\circ\text{C}$

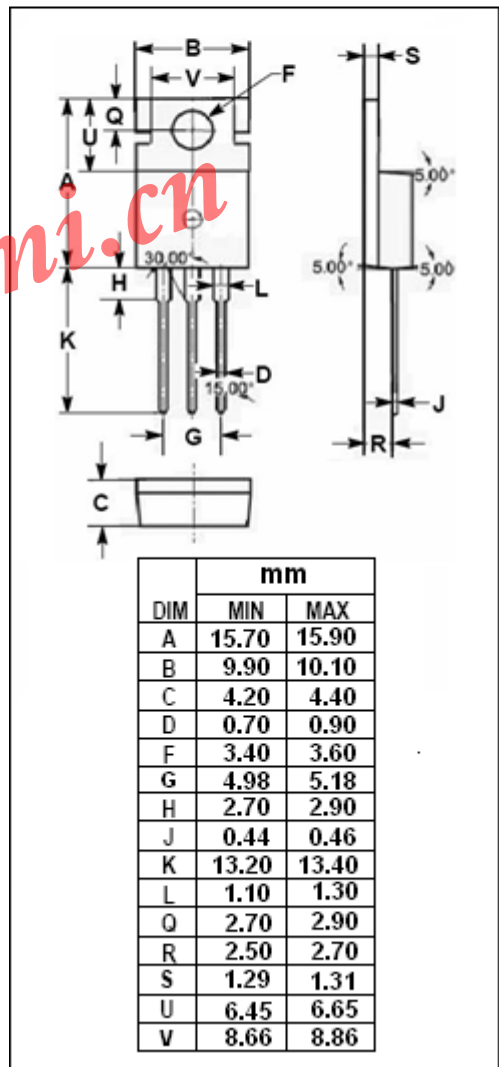
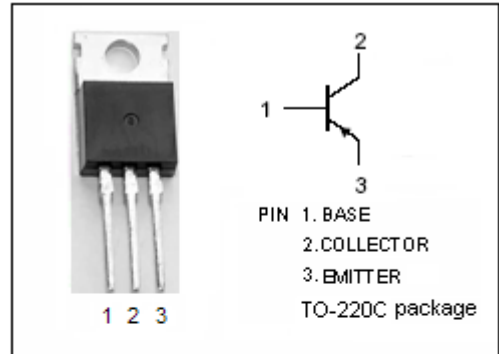

isc Silicon PNP Power Transistor

BD738

www.DataSheet4U.com

ELECTRICAL CHARACTERISTICS

 $T_C=25^\circ\text{C}$ unless otherwise specified

SYMBOL	PARAMETER	CONDITIONS	MIN	MAX	UNIT
$V_{(BR)CEO}$	Collector-Emitter Breakdown Voltage	$I_C = -30\text{mA}; I_B = 0$	-45		V
$V_{(BR)CBO}$	Collector-Base Breakdown Voltage	$I_C = -0.1\text{mA}; I_E = 0$	-45		V
$V_{(BR)EBO}$	Emitter-Base Breakdown Voltage	$I_E = -1\text{mA}; I_C = 0$	-5		V
$V_{CE(sat)}$	Collector-Emitter Saturation Voltage	$I_C = -2\text{A}; I_B = -0.2\text{A}$		-0.6	V
$V_{BE(on)}$	Base-Emitter On Voltage	$I_C = -2\text{A}; V_{CE} = -1\text{V}$		-1.1	V
I_{CES}	Collector Cutoff Current	$V_{CE} = -45\text{V}; V_{BE} = 0$		-0.2	mA
h_{FE-1}	DC Current Gain	$I_C = -20\text{mA}; V_{CE} = -4\text{V}$	40		
h_{FE-2}	DC Current Gain	$I_C = -2\text{A}; V_{CE} = -1\text{V}$	40		

www.iscsemi.cn