

3.3 V OPERATION 4M-WORD BY 64-BIT DYNAMIC RAM MODULE

UNBUFFERED TYPE, EDO

Description

The MC-424LFG641F and MC-424LFG641FW are a 4,194,304 words by 64 bits dynamic RAM modules on which 16 pieces of 16M DRAM (μ PD4216405L), and 4 pieces of 64M DRAM (μ PD4265165) are assembled, respectively.

This module provides high density and large quantities of memory in a small space without utilizing the surface-mounting technology on the printed circuit board.

Decoupling capacitors are mounted on power supply line for noise reduction.

Features

- Unbuffered type
- EDO (Hyper page mode)
- 4,194,304 words by 64 bits organization
- Fast access and cycle time

Family	Access time (MAX.)	R/W cycle time (MIN.)	EDO (Hyper page mode) cycle time (MIN.)	Power consumption (MAX.)	
				Active	Standby
MC-424LFG641F-A60	60 ns	104 ns	25 ns	4.61 W	28.8 mW (CMOS level input)
MC-424LFG641F-A70	70 ns	124 ns	30 ns	4.03 W	
MC-424LFG641FA-A60	60 ns	104 ns	25 ns	4.61 W	
MC-424LFG641FA-A70	70 ns	124 ns	30 ns	4.03 W	
MC-424LFG641FW-A50	50 ns	84 ns	20 ns	2.16 W	7.2 mW (CMOS level input)
MC-424LFG641FW-A60	60 ns	104 ns	25 ns	1.88 W	

- Refresh cycle

Family	Refresh cycle	Refresh
MC-424LFG641-A50	4,096 cycles / 64 ms	/RAS only refresh, Normal read / write, /CAS before /RAS refresh, Hidden refresh
MC-424LFG641-A60		
MC-424LFG641-A70		

- 168-pin dual in-line memory module (Pin pitch = 1.27 mm)
- Single +3.3 V \pm 0.3 V power supply
- Serial PD

The information in this document is subject to change without notice.

Ordering Information

Part number	Access time (MAX.)	Package	Mounted devices
MC-424LFG641F-A60	60 ns	168-pin Dual In-line Memory Module (Socket Type) Edge connector : Gold plated	16 pieces of μ PD4216405LG3 (300 mil TSOP(II))
MC-424LFG641F-A70	70 ns		[Double side]
MC-424LFG641FA-A60	60 ns		16 pieces of μ PD4216405LLA (400 mil SOJ)
MC-424LFG641FA-A70	70 ns		[Double side]
MC-424LFG641FW-A50	50 ns		4 pieces of μ PD4265165G5 (400 mil TSOP(II))
MC-424LFG641FW-A60	60 ns		[Single side]

Pin Configuration

168-pin Dual In-line Memory Module Socket Type (Edge connector: Gold plated)

[MC-424LFG641F, 424LFG641FA, 424LFG641FW]

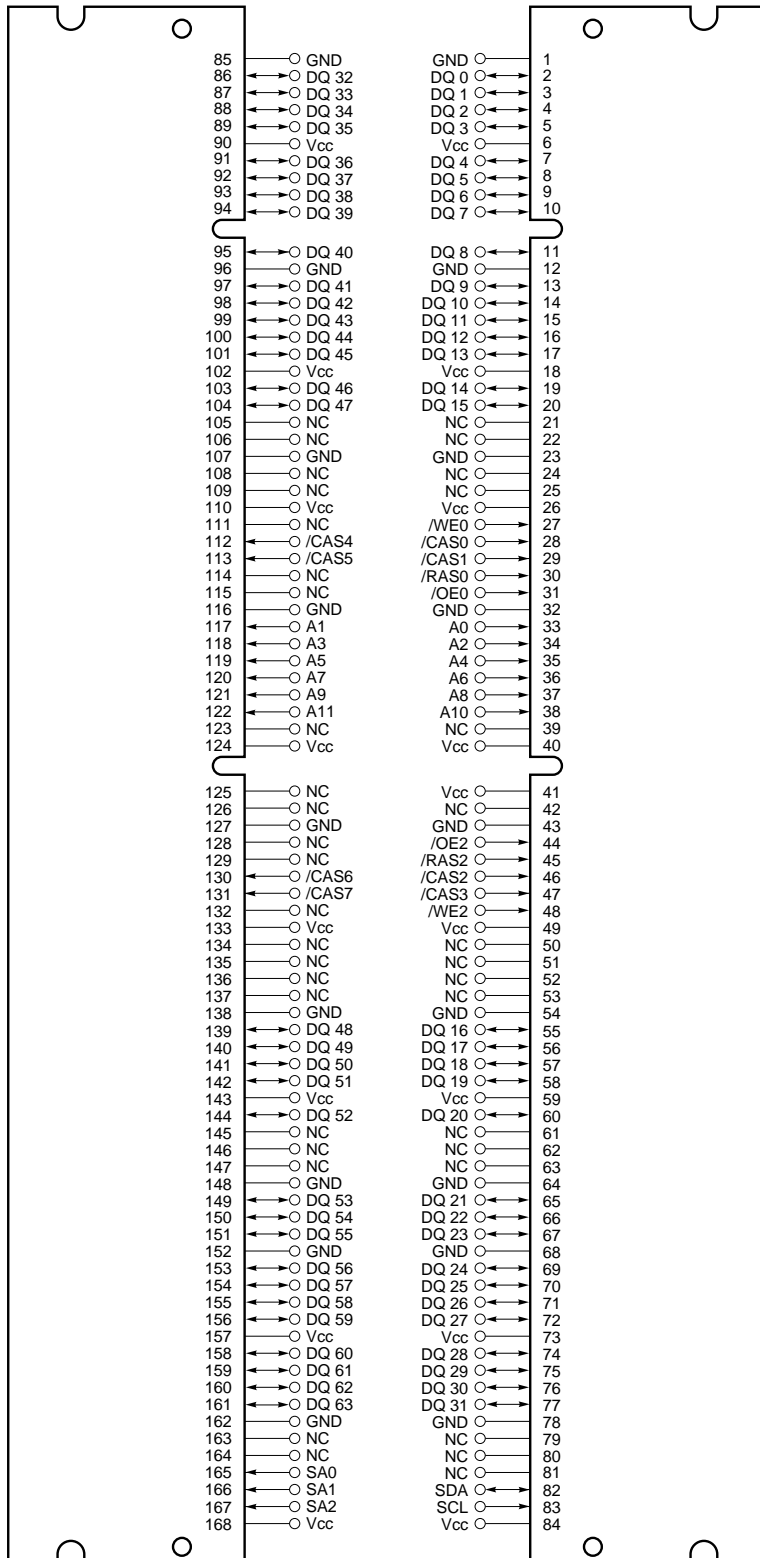

/XXX indicates active low signal.

- A0 - A11 : Address Inputs
- [Row : A0 - A11, Column : A0 - A9]
- DQ0 - DQ63 : Data Inputs / Outputs
- /RAS0, /RAS2 : Row Address Strobe
- /CAS0 - /CAS7 : Column Address Strobe
- /WE0, /WE2 : Write Enable
- /OE0, /OE2 : Output Enable
- SDA : Serial Data I/O for PD
- SCL : Clock Input for PD
- SA0 - SA2 : Address Input for EEPROM
- Vcc : Power Supply
- GND : Ground
- NC : No Connection

Block Diagram

[MC-424LFG641F, 424LFG641FA]

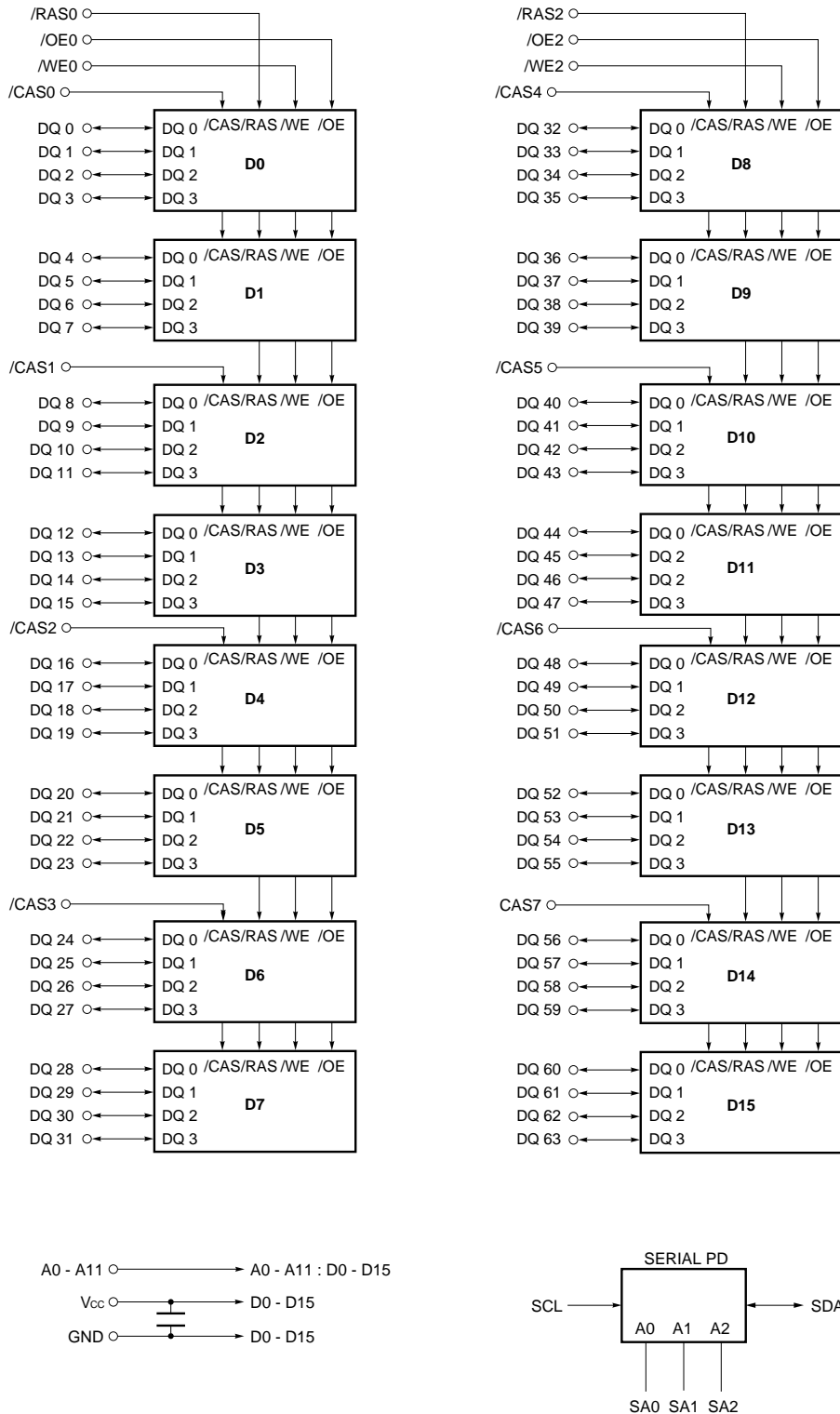

Remark D0 - D15 : μ PD4216405L (4M words by 4 bits organization)

[MC-424LFG641FW]

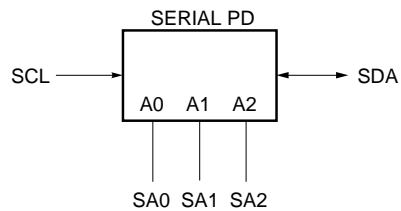
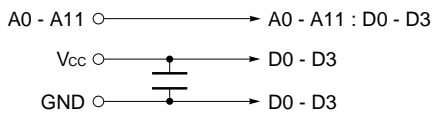
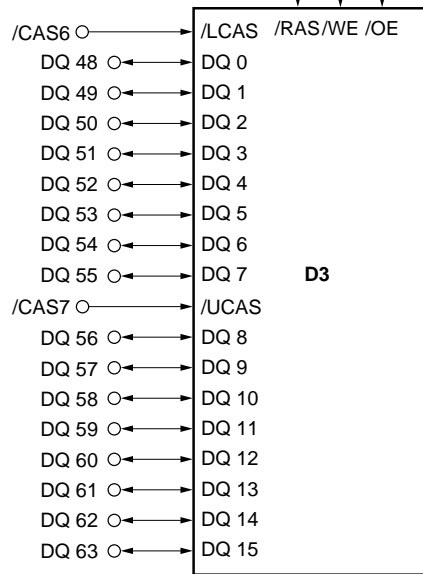
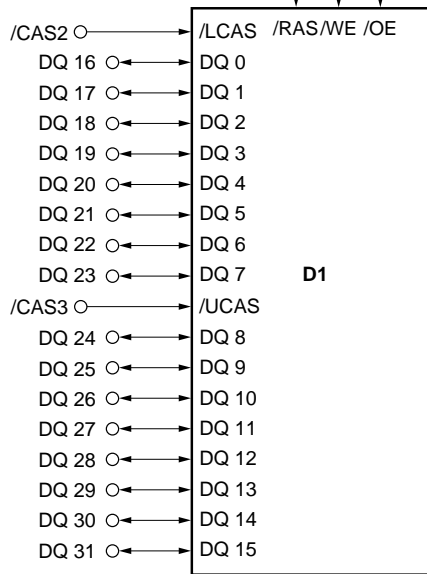
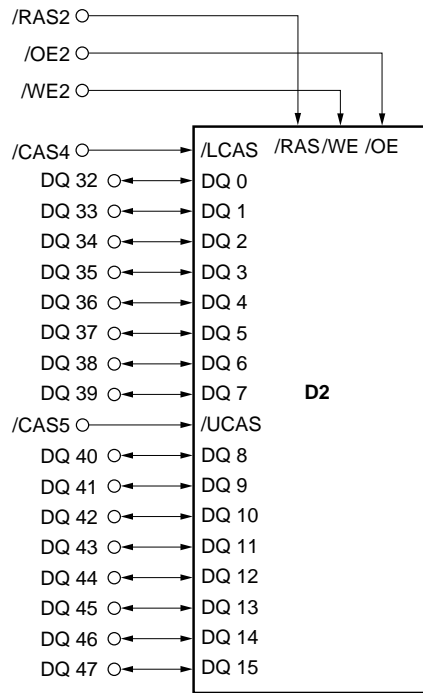
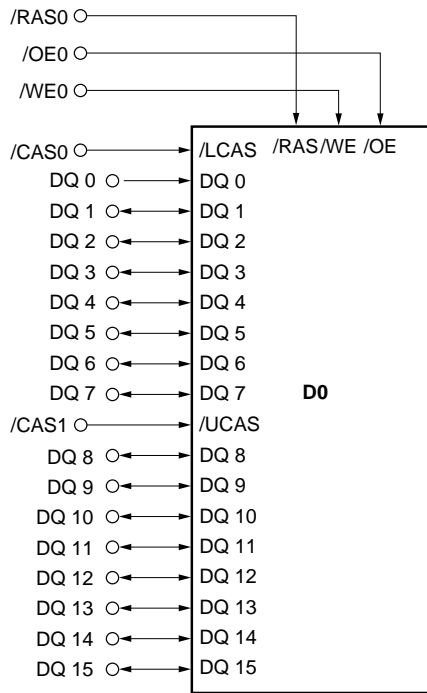

Remark D0 - D3 : μ PD4265165 (4M words by 16 bits organization)

Electrical Specifications

- All voltages are referenced to GND.
- After power up ($V_{CC} \geq V_{CC(MIN.)}$), wait more than 100 μs (/RAS, /CAS inactive) and then, execute eight /CAS before /RAS or /RAS only refresh cycles as dummy cycles to initialize internal circuit.

Absolute Maximum Ratings

Parameter	Symbol	Condition	Rating	Unit
Voltage on any pin relative to GND	V_T		-0.5 to +4.6	V
Supply voltage	V_{CC}		-0.5 to +4.6	V
Output current	I_o		20	mA
Power dissipation	P_D	MC-424LFG641F, MC-424LFG641FA	16	W
		MC-424LFG641FW	4	W
Operating ambient temperature	T_A		0 to +70	$^{\circ}C$
Storage temperature	T_{stg}		-55 to +125	$^{\circ}C$

Caution Exposing the device to stress above those listed in Absolute Maximum Ratings could cause permanent damage. The device is not meant to be operated under conditions outside the limits described in the operational section of this specification. Exposure to Absolute Maximum Rating conditions for extended periods may affect device reliability.

Recommended Operating Conditions

Parameter	Symbol	Condition	MIN.	TYP.	MAX.	Unit
Supply voltage	V_{CC}		3.0	3.3	3.6	V
High level input voltage	V_{IH}		2.0		$V_{CC} + 0.3$	V
Low level input voltage	V_{IL}		-0.3		+0.8	V
Operating ambient temperature	T_A		0		70	$^{\circ}C$

Capacitance (T_A = 25 °C, f = 1 MHz)

[MC-424LFG641F, 424LFG641FA]

Parameter	Symbol	Test condition	MIN.	TYP.	MAX.	Unit
Input capacitance	C ₁₁	A0 - A11			110	pF
	C ₁₂	/RAS0, /RAS2			80	
	C ₁₃	/CAS0 - /CAS7			40	
	C ₁₄	/WE0, /WE2			80	
	C ₁₅	/OE0, /OE2			80	
Data input/output capacitance	C _{I/O}	DQ0 - DQ63			30	pF

[MC-424LFG641FW]

Parameter	Symbol	Test condition	MIN.	TYP.	MAX.	Unit
Input capacitance	C ₁₁	A0 - A11			45	pF
	C ₁₂	/RAS0, /RAS2			40	
	C ₁₃	/CAS0 - /CAS7			30	
	C ₁₄	/WE0, /WE2			40	
	C ₁₅	/OE0, /OE2			40	
Data input/output capacitance	C _{I/O}	DQ0 - DQ63			30	pF

DC Characteristics (Recommended Operating Conditions unless otherwise noted)

[MC-424LFG641F, 424LFG641FA]

Parameter	Symbol	Test condition	MIN.	MAX.	Unit	Notes	
Operating current	I _{CC1}	/RAS, /CAS cycling t _{RC} = t _{RC(MIN.)} , I _O = 0 mA	t _{RAC} = 60 ns		1,280	mA	1, 2, 3
			t _{RAC} = 70 ns		1,120		
Standby current	I _{CC2}	/RAS, /CAS ≥ V _{IH(MIN.)} , I _O = 0 mA		32	mA		
		/RAS, /CAS ≥ V _{CC} -0.2 V, I _O = 0 mA		8			
/RAS only refresh current	I _{CC3}	/RAS cycling, /CAS ≥ V _{IH(MIN.)} t _{RC} = t _{RC(MIN.)} , I _O = 0 mA	t _{RAC} = 60 ns		1,280	mA	1, 2, 3, 4
			t _{RAC} = 70 ns		1,120		
Operating current (Hyper page mode (EDO))	I _{CC4}	/RAS ≤ V _{IL(MAX.)} , /CAS cycling t _{HPC} = t _{HPC(MIN.)} , I _O = 0 mA	t _{RAC} = 60 ns		1,440	mA	1, 2, 5
			t _{RAC} = 70 ns		1,280		
/CAS before /RAS refresh current	I _{CC5}	/RAS cycling t _{RC} = t _{RC(MIN.)} , I _O = 0 mA	t _{RAC} = 60 ns		1,280	mA	1, 2
			t _{RAC} = 70 ns		1,120		
Input leakage current	I _{I(L)}	V _I = 0 to 3.6 V All other pins not under test = 0 V	Address	-80	+80	μA	
			/RAS, /WE, /OE	-40	+40		
			/CAS	-10	+10		
Output leakage current	I _{O(L)}	V _O = 0 to 3.6 V Output is disabled (Hi-Z)	-5	+5	μA		
High level output voltage	V _{OH}	I _O = -2.0 mA	2.4		V		
Low level output voltage	V _{OL}	I _O = +2.0 mA		0.4	V		

Notes 1. I_{CC1}, I_{CC3}, I_{CC4} and I_{CC5} depend on cycle rates (t_{RC} and t_{HPC}).

2. Specified values are obtained with outputs unloaded.

3. I_{CC1} and I_{CC3} are measured assuming that address can be changed once or less during /RAS ≤ V_{IL(MAX.)} and /CAS ≥ V_{IH(MIN.)}.

4. I_{CC3} is measured assuming that all column address inputs are held at either high or low.

5. I_{CC4} is measured assuming that all column address inputs are switched only once during each hyper page (EDO) cycle.

[MC-424LFG641FW]

Parameter	Symbol	Test condition	MIN.	MAX.	Unit	Notes
Operating current	I _{CC1}	/RAS, /CAS cycling t _{RC} = t _{RC (MIN.)} , I _O = 0 mA	t _{RAC} = 50 ns	600	mA	1, 2, 3
			t _{RAC} = 60 ns	520		
Standby current	I _{CC2}	/RAS, /CAS ≥ V _{IH (MIN.)} , I _O = 0 mA		4	mA	
		/RAS, /CAS ≥ V _{CC} -0.2 V, I _O = 0 mA		2		
/RAS only refresh current	I _{CC3}	/RAS cycling, /CAS ≥ V _{IH (MIN.)} t _{RC} = t _{RC (MIN.)} , I _O = 0 mA	t _{RAC} = 50 ns	600	mA	1, 2, 3, 4
			t _{RAC} = 60 ns	520		
Operating current (Hyper page mode (EDO))	I _{CC4}	/RAS ≤ V _{IL (MAX.)} , /CAS cycling t _{HPC} = t _{HPC (MIN.)} , I _O = 0 mA	t _{RAC} = 50 ns	480	mA	1, 2, 5
			t _{RAC} = 60 ns	400		
/CAS before /RAS refresh current	I _{CC5}	/RAS cycling t _{RC} = t _{RC (MIN.)} , I _O = 0 mA	t _{RAC} = 50 ns	600	mA	1, 2
			t _{RAC} = 60 ns	520		
★ Input leakage current	I _{I (L)}	V _I = 0 to 3.6 V All other pins not under test = 0 V	Address	-20	+20	μA
			/RAS, /WE, /OE	-10	+10	
			/CAS	-5	+5	
Output leakage current	I _{O (L)}	V _O = 0 to 3.6 V Output is disabled (Hi-Z)	-5	+5	μA	
High level output voltage	V _{OH}	I _O = -2.0 mA	2.4		V	
Low level output voltage	V _{OL}	I _O = +2.0 mA		0.4	V	

Notes 1. I_{CC1}, I_{CC3}, I_{CC4} and I_{CC5} depend on cycle rates (t_{RC} and t_{HPC}).

2. Specified values are obtained with outputs unloaded.

3. I_{CC1} and I_{CC3} are measured assuming that address can be changed once or less during /RAS ≤ V_{IL (MAX.)} and /CAS ≥ V_{IH (MIN.)}.

4. I_{CC3} is measured assuming that all column address inputs are held at either high or low.

5. I_{CC4} is measured assuming that all column address inputs are switched only once during each hyper page (EDO) cycle.

AC Characteristics (Recommended Operating Conditions unless otherwise noted)

AC Characteristics Test Conditions

(1) Input timing specification

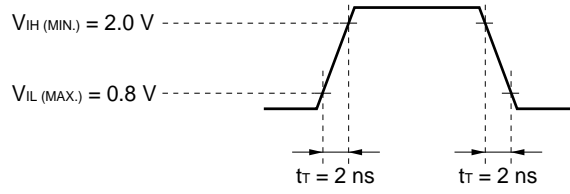

(2) Output timing specification

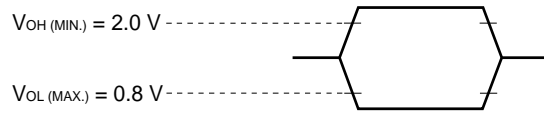

(3) Output load condition

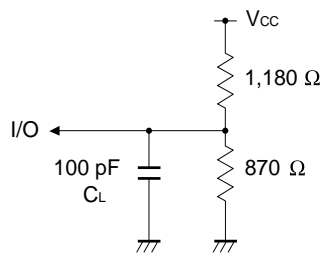

Common to Read, Write, Read Modify Write Cycle

[MC-424LFG641F, 424LFG641FA]

Parameter	Symbol	t _{RAC} = 60 ns		t _{RAC} = 70 ns		Unit	Notes
		MIN.	MAX.	MIN.	MAX.		
Read / Write cycle time	t _{RC}	104	–	124	–	ns	
/RAS precharge time	t _{RP}	40	–	50	–	ns	
/CAS precharge time	t _{CPN}	10	–	10	–	ns	
/RAS pulse width	t _{RAS}	60	10,000	70	10,000	ns	
/CAS pulse width	t _{CAS}	10	10,000	12	10,000	ns	
/RAS hold time	t _{RSH}	15	–	20	–	ns	
/CAS hold time	t _{CSH}	45	–	50	–	ns	
/RAS to /CAS delay time	t _{RCD}	14	45	14	52	ns	1
/RAS to column address delay time	t _{RAD}	12	30	12	35	ns	1
/CAS to /RAS precharge time	t _{CRP}	5	–	5	–	ns	2
Row address setup time	t _{ASR}	0	–	0	–	ns	
Row address hold time	t _{RAH}	10	–	10	–	ns	
Column address setup time	t _{ASC}	0	–	0	–	ns	
Column address hold time	t _{CAH}	10	–	12	–	ns	
/OE lead time referenced to /RAS	t _{OES}	0	–	0	–	ns	
/CAS to data setup time	t _{CLZ}	0	–	0	–	ns	
/OE to data setup time	t _{OLZ}	0	–	0	–	ns	
/OE to data delay time	t _{OED}	13	–	15	–	ns	
Transition time (rise and fall)	t _r	1	50	1	50	ns	
Refresh time	t _{REF}	–	64	–	64	ms	

Notes 1. For read cycles, access time is defined as follows:

Input conditions	Access time	Access time from /RAS
t _{RAD} ≤ t _{RAD} (MAX.) and t _{RCD} ≤ t _{RCD} (MAX.)	t _{RAC} (MAX.)	t _{RAC} (MAX.)
t _{RAD} > t _{RAD} (MAX.) and t _{RCD} ≤ t _{RCD} (MAX.)	t _{AA} (MAX.)	t _{RAD} + t _{AA} (MAX.)
t _{RCD} > t _{RCD} (MAX.)	t _{CAC} (MAX.)	t _{RCD} + t _{CAC} (MAX.)

t_{RAD} (MAX.) and t_{RCD} (MAX.) are specified as reference points only; they are not restrictive operating parameters. They are used to determine which access time (t_{RAC}, t_{AA} or t_{CAC}) is to be used for finding out when output data will be available. Therefore, the input conditions t_{RAD} ≥ t_{RAD} (MAX.) and t_{RCD} ≥ t_{RCD} (MAX.) will not cause any operation problems.

2. t_{CRP} (MIN.) requirement is applied to /RAS, /CAS cycles.

[MC-424LFG641FW]

Parameter	Symbol	t _{RAC} = 50 ns		t _{RAC} = 60 ns		Unit	Notes
		MIN.	MAX.	MIN.	MAX.		
Read / Write cycle time	t _{RC}	84	–	104	–	ns	
/RAS precharge time	t _{RP}	30	–	40	–	ns	
/CAS precharge time	t _{CPN}	7	–	10	–	ns	
/RAS pulse width	t _{RAS}	50	10,000	60	10,000	ns	
/CAS pulse width	t _{CAS}	8	10,000	10	10,000	ns	
/RAS hold time	t _{RSH}	13	–	15	–	ns	
/CAS hold time	t _{CSH}	38	–	40	–	ns	
/RAS to /CAS delay time	t _{RCD}	11	37	14	45	ns	1
/RAS to column address delay time	t _{RAD}	9	25	12	30	ns	1
/CAS to /RAS precharge time	t _{CRP}	5	–	5	–	ns	2
Row address setup time	t _{ASR}	0	–	0	–	ns	
Row address hold time	t _{RAH}	7	–	10	–	ns	
Column address setup time	t _{ASC}	0	–	0	–	ns	
Column address hold time	t _{CAH}	7	–	10	–	ns	
/OE lead time referenced to /RAS	t _{OES}	0	–	0	–	ns	
/CAS to data setup time	t _{CLZ}	0	–	0	–	ns	
/OE to data setup time	t _{OLZ}	0	–	0	–	ns	
/OE to data delay time	t _{OED}	10	–	13	–	ns	
Transition time (rise and fall)	t _r	1	50	1	50	ns	
Refresh time	t _{REF}	–	64	–	64	ms	

Notes 1. For read cycles, access time is defined as follows:

Input conditions	Access time	Access time from /RAS
t _{RAD} ≤ t _{RAD} (MAX.) and t _{RCD} ≤ t _{RCD} (MAX.)	t _{RAC} (MAX.)	t _{RAC} (MAX.)
t _{RAD} > t _{RAD} (MAX.) and t _{RCD} ≤ t _{RCD} (MAX.)	t _{AA} (MAX.)	t _{RAD} + t _{AA} (MAX.)
t _{RCD} > t _{RCD} (MAX.)	t _{CAC} (MAX.)	t _{RCD} + t _{CAC} (MAX.)

t_{RAD} (MAX.) and t_{RCD} (MAX.) are specified as reference points only; they are not restrictive operating parameters. They are used to determine which access time (t_{RAC}, t_{AA} or t_{CAC}) is to be used for finding out when output data will be available. Therefore, the input conditions t_{RAD} ≥ t_{RAD} (MAX.) and t_{RCD} ≥ t_{RCD} (MAX.) will not cause any operation problems.

2. t_{CRP} (MIN.) requirement is applied to /RAS, /CAS cycles.

Read Cycle

[MC-424LFG641F, 424LFG641FA]

Parameter	Symbol	t _{RAC} = 60 ns		t _{RAC} = 70 ns		Unit	Notes
		MIN.	MAX.	MIN.	MAX.		
Access time from /RAS	t _{RAC}	–	60	–	70	ns	1
Access time from /CAS	t _{CAC}	–	17	–	20	ns	1
Access time from column address	t _{AA}	–	30	–	35	ns	1
Access time from /OE	t _{OEa}	–	17	–	20	ns	
Column address lead time referenced to /RAS	t _{RAL}	30	–	35	–	ns	
Read command setup time	t _{RCS}	0	–	0	–	ns	
Read command hold time referenced to /RAS	t _{RRH}	0	–	0	–	ns	2
Read command hold time referenced to /CAS	t _{RCH}	0	–	0	–	ns	2
Output buffer turn-off delay time from /OE	t _{OEZ}	0	13	0	15	ns	3
/CAS hold time to /OE	t _{CHO}	5	–	5	–	ns	4

Notes 1. For read cycles, access time is defined as follows:

Input conditions	Access time	Access time from /RAS
t _{RAD} ≤ t _{RAD (MAX.)} and t _{RCD} ≤ t _{RCD (MAX.)}	t _{RAC (MAX.)}	t _{RAC (MAX.)}
t _{RAD} > t _{RAD (MAX.)} and t _{RCD} ≤ t _{RCD (MAX.)}	t _{AA (MAX.)}	t _{RAD} + t _{AA (MAX.)}
t _{RCD} > t _{RCD (MAX.)}	t _{CAC (MAX.)}	t _{RCD} + t _{CAC (MAX.)}

t_{RAD (MAX.)} and t_{RCD (MAX.)} are specified as reference points only; they are not restrictive operating parameters. They are used to determine which access time (t_{RAC}, t_{AA} or t_{CAC}) is to be used for finding out when output data will be available. Therefore, the input conditions t_{RAD} ≥ t_{RAD (MAX.)} and t_{RCD} ≥ t_{RCD (MAX.)} will not cause any operation problems.

2. Either t_{RCH (MIN.)} or t_{RRH (MIN.)} should be met in read cycles.
3. t_{OEZ (MAX.)} defines the time when the output achieves the condition of Hi-Z and is not referenced to V_{OH} or V_{OL}.
4. /WE : inactive (in read cycle)
 /CAS : inactive, /OE : active t_{CHO} is effective.
 /RAS, /OE : active t_{CH} is effective.

[MC-424LFG641FW]

Parameter	Symbol	t _{RAC} = 50 ns		t _{RAC} = 60 ns		Unit	Notes
		MIN.	MAX.	MIN.	MAX.		
Access time from /RAS	t _{RAC}	–	50	–	60	ns	1
Access time from /CAS	t _{CAC}	–	13	–	15	ns	1
Access time from column address	t _{AA}	–	25	–	30	ns	1
Access time from /OE	t _{OE A}	–	13	–	15	ns	
Column address lead time referenced to /RAS	t _{RAL}	25	–	30	–	ns	
Read command setup time	t _{RCS}	0	–	0	–	ns	
Read command hold time referenced to /RAS	t _{RRH}	0	–	0	–	ns	2
Read command hold time referenced to /CAS	t _{RCH}	0	–	0	–	ns	2
Output buffer turn-off delay time from /OE	t _{OEZ}	0	10	0	13	ns	3
/CAS hold time to /OE	t _{CHO}	5	–	5	–	ns	4

Notes 1. For read cycles, access time is defined as follows:

Input conditions	Access time	Access time from /RAS
t _{RAD} ≤ t _{RAD (MAX.)} and t _{RCD} ≤ t _{RCD (MAX.)}	t _{RAC (MAX.)}	t _{RAC (MAX.)}
t _{RAD} > t _{RAD (MAX.)} and t _{RCD} ≤ t _{RCD (MAX.)}	t _{AA (MAX.)}	t _{RAD} + t _{AA (MAX.)}
t _{RCD} > t _{RCD (MAX.)}	t _{CAC (MAX.)}	t _{RCD} + t _{CAC (MAX.)}

t_{RAD (MAX.)} and t_{RCD (MAX.)} are specified as reference points only; they are not restrictive operating parameters. They are used to determine which access time (t_{RAC}, t_{AA} or t_{CAC}) is to be used for finding out when output data will be available. Therefore, the input conditions t_{RAD} ≥ t_{RAD (MAX.)} and t_{RCD} ≥ t_{RCD (MAX.)} will not cause any operation problems.

2. Either t_{RCH (MIN.)} or t_{RRH (MIN.)} should be met in read cycles.
3. t_{OEZ (MAX.)} defines the time when the output achieves the condition of Hi-Z and is not referenced to V_{OH} or V_{OL}.
4. /WE : inactive (in read cycle)
 /CAS : inactive, /OE : active t_{CHO} is effective.
 /RAS, /OE : active t_{CH} is effective.

Write Cycle

[MC-424LFG641F, 424LFG641FA]

Parameter	Symbol	t _{TRAC} = 60 ns		t _{TRAC} = 70 ns		Unit	Notes
		MIN.	MAX.	MIN.	MAX.		
/WE hold time referenced to /CAS	t _{WCH}	10	–	10	–	ns	1
/WE pulse width	t _{WP}	10	–	10	–	ns	1
/WE lead time referenced to /RAS	t _{RWL}	15	–	20	–	ns	
/WE lead time referenced to /CAS	t _{CWL}	10	–	12	–	ns	
/WE setup time	t _{WCS}	0	–	0	–	ns	2
/OE hold time	t _{OEH}	0	–	0	–	ns	
Data-in setup time	t _{DS}	0	–	0	–	ns	3
Data-in hold time	t _{DH}	10	–	15	–	ns	3

- Notes**
1. t_{WP} (MIN.) is applied to late write cycles or read modify write cycles. In early write cycles, t_{WCH} (MIN.) should be met.
 2. If t_{WCS} ≥ t_{WCS} (MIN.), the cycle is an early write cycle and the data out will remain Hi-Z through the entire cycle.
 3. t_{DS} (MIN.) and t_{DH} (MIN.) are referenced to the /CAS falling edge in early write cycles. In late write cycles and read modify write cycles, they are referenced to the /WE falling edge.

[MC-424LFG641FW]

Parameter	Symbol	t _{TRAC} = 50 ns		t _{TRAC} = 60 ns		Unit	Notes
		MIN.	MAX.	MIN.	MAX.		
/WE hold time referenced to /CAS	t _{WCH}	7	–	10	–	ns	1
/WE pulse width	t _{WP}	7	–	10	–	ns	1
/WE lead time referenced to /RAS	t _{RWL}	13	–	15	–	ns	
/WE lead time referenced to /CAS	t _{CWL}	7	–	10	–	ns	
/WE setup time	t _{WCS}	0	–	0	–	ns	2
/OE hold time	t _{OEH}	0	–	0	–	ns	
Data-in setup time	t _{DS}	0	–	0	–	ns	3
Data-in hold time	t _{DH}	7	–	10	–	ns	3

- Notes**
1. t_{WP} (MIN.) is applied to late write cycles or read modify write cycles. In early write cycles, t_{WCH} (MIN.) should be met.
 2. If t_{WCS} ≥ t_{WCS} (MIN.), the cycle is an early write cycle and the data out will remain Hi-Z through the entire cycle.
 3. t_{DS} (MIN.) and t_{DH} (MIN.) are referenced to the /CAS falling edge in early write cycles. In late write cycles and read modify write cycles, they are referenced to the /WE falling edge.

Read Modify Write Cycle

[MC-424LFG641F, 424LFG641FA]

Parameter	Symbol	t _{TRAC} = 60 ns		t _{TRAC} = 70 ns		Unit	Note
		MIN.	MAX.	MIN.	MAX.		
Read modify write cycle time	t _{RWC}	133	–	157	–	ns	
/RAS to /WE delay time	t _{RWD}	77	–	89	–	ns	1
/CAS to /WE delay time	t _{CWD}	32	–	37	–	ns	1
Column address to /WE delay time	t _{AWD}	47	–	54	–	ns	1

Note 1. If $t_{WCS} \geq t_{WCS} (MIN.)$, the cycle is an early write cycle and the data out will remain Hi-Z through the entire cycle.
 If $t_{RWD} \geq t_{RWD} (MIN.)$, $t_{CWD} \geq t_{CWD} (MIN.)$, $t_{AWD} \geq t_{AWD} (MIN.)$ and $t_{CPWD} \geq t_{CPWD} (MIN.)$, the cycle is a read modify write cycle and the data out will contain data read from the selected cell. If neither of the above conditions is met, the state of the data out is indeterminate.

[MC-424LFG641FW]

Parameter	Symbol	t _{TRAC} = 50 ns		t _{TRAC} = 60 ns		Unit	Note
		MIN.	MAX.	MIN.	MAX.		
Read modify write cycle time	t _{RWC}	107	–	133	–	ns	
/RAS to /WE delay time	t _{RWD}	64	–	77	–	ns	1
/CAS to /WE delay time	t _{CWD}	27	–	32	–	ns	1
Column address to /WE delay time	t _{AWD}	39	–	47	–	ns	1

Note 1. If $t_{WCS} \geq t_{WCS} (MIN.)$, the cycle is an early write cycle and the data out will remain Hi-Z through the entire cycle.
 If $t_{RWD} \geq t_{RWD} (MIN.)$, $t_{CWD} \geq t_{CWD} (MIN.)$, $t_{AWD} \geq t_{AWD} (MIN.)$ and $t_{CPWD} \geq t_{CPWD} (MIN.)$, the cycle is a read modify write cycle and the data out will contain data read from the selected cell. If neither of the above conditions is met, the state of the data out is indeterminate.

Hyper Page Mode (EDO)

[MC-424LFG641F, 424LFG641FA]

Parameter	Symbol	t _{RAC} = 60 ns		t _{RAC} = 70 ns		Unit	Notes
		MIN.	MAX.	MIN.	MAX.		
Read / Write cycle time	t _{HPC}	25	–	30	–	ns	1
/RAS pulse width	t _{RASP}	60	125,000	70	125,000	ns	
/CAS pulse width	t _{HCAS}	10	10,000	12	10,000	ns	
/CAS precharge time	t _{CP}	10	–	10	–	ns	
Access time from /CAS precharge	t _{ACP}	–	35	–	40	ns	
/CAS precharge to /WE delay time	t _{CPWD}	52	–	59	–	ns	2
/RAS hold time from /CAS precharge	t _{RHCP}	35	–	40	–	ns	
Read modify write cycle time	t _{HPRWC}	66	–	75	–	ns	
Data output hold time	t _{DHC}	5	–	5	–	ns	
/OE to /CAS hold time	t _{OCH}	5	–	5	–	ns	3
/OE precharge time	t _{OEP}	5	–	5	–	ns	
Output buffer turn-off delay from /WE	t _{WEZ}	0	13	0	15	ns	4,5
/WE pulse width	t _{WPZ}	10	–	10	–	ns	5
Output buffer turn-off delay from /RAS	t _{OFR}	0	13	0	15	ns	4,5
Output buffer turn-off delay from /CAS	t _{OFC}	0	13	0	15	ns	4,5

Notes 1. t_{HPC} (MIN.) is applied to /CAS access.

2. If t_{WCS} ≥ t_{WCS} (MIN.), the cycle is an early write cycle and the data out will remain Hi-Z through the entire cycle. If t_{TRWD} ≥ t_{TRWD} (MIN.), t_{TCWD} ≥ t_{TCWD} (MIN.), t_{TAWD} ≥ t_{TAWD} (MIN.) and t_{CPWD} ≥ t_{CPWD} (MIN.), the cycle is a read modify write cycle and the data out will contain data read from the selected cell. If neither of the above conditions is met, the state of the data out is indeterminate.

3. /WE : inactive (in read cycle)

/CAS : inactive, /OE : active t_{CHO} is effective.

/CAS, /OE : active t_{OCH} is effective.

4. t_{OFC} (MAX.), t_{OFR} (MAX.) and t_{WEZ} (MAX.) define the time when the output achieves the conditions of Hi-Z and is not referenced to V_{OH} or V_{OL}.

5. To make DQs to Hi-Z in read cycle, it is necessary to control /RAS, /CAS, /WE, /OE as follows. The effective specification depends on state of each signal.

(1) Both /RAS and /CAS are inactive (at the end of the read cycle)

/WE : inactive, /OE : active

t_{OFC} is effective when /RAS is inactivated before /CAS is inactivated.

t_{OFR} is effective when /CAS is inactivated before /RAS is inactivated.

The slower of t_{OFC} and t_{OFR} becomes effective.

(2) Both /RAS and /CAS are active or either /RAS or /CAS is active (in read cycle)

/WE, /OE : inactive t_{OEZ} is effective.

Both /RAS and /CAS are inactive or /RAS is active and /CAS is inactive (at the end of read cycle)

/WE, /OE : active and either t_{RRH} or t_{TRCH} must be met t_{WEZ} and t_{WPZ} are effective.

The faster of t_{OEZ} and t_{WEZ} becomes effective.

The faster of (1) and (2) becomes effective.

[MC-424LFG641FW]

Parameter	Symbol	t _{RAC} = 50 ns		t _{RAC} = 60 ns		Unit	Notes
		MIN.	MAX.	MIN.	MAX.		
Read / Write cycle time	t _{HPC}	20	–	25	–	ns	1
/RAS pulse width	t _{RASP}	50	125,000	60	125,000	ns	
/CAS pulse width	t _{HCAS}	8	10,000	10	10,000	ns	
/CAS precharge time	t _{CP}	7	–	10	–	ns	
Access time from /CAS precharge	t _{ACP}	–	30	–	35	ns	
/CAS precharge to /WE delay time	t _{CPWD}	41	–	52	–	ns	2
/RAS hold time from /CAS precharge	t _{RHCP}	30	–	35	–	ns	
Read modify write cycle time	t _{HPRWC}	52	–	66	–	ns	
Data output hold time	t _{DHC}	5	–	5	–	ns	
/OE to /CAS hold time	t _{OCH}	5	–	5	–	ns	3
/OE precharge time	t _{OEP}	5	–	5	–	ns	
Output buffer turn-off delay from /WE	t _{WEZ}	0	10	0	13	ns	4,5
/WE pulse width	t _{WPZ}	7	–	10	–	ns	5
Output buffer turn-off delay from /RAS	t _{OFR}	0	10	0	13	ns	4,5
Output buffer turn-off delay from /CAS	t _{OFC}	0	10	0	13	ns	4,5

Notes 1. t_{HPC} (MIN.) is applied to /CAS access.

2. If t_{WCS} ≥ t_{WCS} (MIN.), the cycle is an early write cycle and the data out will remain Hi-Z through the entire cycle. If t_{TRWD} ≥ t_{TRWD} (MIN.), t_{TCWD} ≥ t_{TCWD} (MIN.), t_{AWD} ≥ t_{AWD} (MIN.) and t_{CPWD} ≥ t_{CPWD} (MIN.), the cycle is a read modify write cycle and the data out will contain data read from the selected cell. If neither of the above conditions is met, the state of the data out is indeterminate.

3. /WE : inactive (in read cycle)

/CAS : inactive, /OE : active t_{CHO} is effective.

/CAS, /OE : active t_{OCH} is effective.

4. t_{OFC} (MAX.), t_{OFR} (MAX.) and t_{WEZ} (MAX.) define the time when the output achieves the conditions of Hi-Z and is not referenced to V_{OH} or V_{OL}.

5. To make DQs to Hi-Z in read cycle, it is necessary to control /RAS, /CAS, /WE, /OE as follows. The effective specification depends on state of each signal.

(1) Both /RAS and /CAS are inactive (at the end of the read cycle)

/WE : inactive, /OE : active

t_{OFC} is effective when /RAS is inactivated before /CAS is inactivated.

t_{OFR} is effective when /CAS is inactivated before /RAS is inactivated.

The slower of t_{OFC} and t_{OFR} becomes effective.

(2) Both /RAS and /CAS are active or either /RAS or /CAS is active (in read cycle)

/WE, /OE : inactive t_{WEZ} is effective.

Both /RAS and /CAS are inactive or /RAS is active and /CAS is inactive (at the end of read cycle)

/WE, /OE : active and either t_{RRH} or t_{TRCH} must be met t_{WEZ} and t_{WPZ} are effective.

The faster of t_{WEZ} and t_{WEZ} becomes effective.

The faster of (1) and (2) becomes effective.

Refresh Cycle

[MC-424LFG641F, 424LFG641FA]

Parameter	Symbol	t _{RAC} = 60 ns		t _{RAC} = 70 ns		Unit	Note
		MIN.	MAX.	MIN.	MAX.		
/CAS setup time	t _{CSR}	5	–	5	–	ns	
/CAS hold time (/CAS before /RAS refresh)	t _{CHR}	10	–	10	–	ns	
/RAS precharge /CAS hold time	t _{RPC}	5	–	5	–	ns	
/WE setup time	t _{WSR}	10	–	10	–	ns	
/WE hold time	t _{WHR}	15	–	15	–	ns	

[MC-424LFG641FW]

Parameter	Symbol	t _{RAC} = 50 ns		t _{RAC} = 60 ns		Unit	Note
		MIN.	MAX.	MIN.	MAX.		
/CAS setup time	t _{CSR}	5	–	5	–	ns	
/CAS hold time (/CAS before /RAS refresh)	t _{CHR}	10	–	10	–	ns	
/RAS precharge /CAS hold time	t _{RPC}	5	–	5	–	ns	
/WE setup time	t _{WSR}	10	–	10	–	ns	
/WE hold time	t _{WHR}	15	–	15	–	ns	

Serial PD

[MC-424LFG641F]

Byte No.	Function Described	Hex	Bit 7	Bit 6	Bit 5	Bit 4	Bit 3	Bit 2	Bit 1	Bit 0	Notes	
0	Number of serial PD bytes	5DH	0	1	0	1	1	1	0	1	93 bytes	
1	Serial memory	08H	0	0	0	0	1	0	0	0	256 bytes	
2	Fundamental memory type	02H	0	0	0	0	0	0	1	0	EDO	
3	Number of rows	0CH	0	0	0	0	1	1	0	0	12 rows	
4	Number of columns	0AH	0	0	0	0	1	0	1	0	10 columns	
5	Number of banks	01H	0	0	0	0	0	0	0	1	1 bank	
6	Data width	40H	0	1	0	0	0	0	0	0	64 bits	
7	Data width (continued)	00H	0	0	0	0	0	0	0	0	0	
8	Voltage interface	01H	0	0	0	0	0	0	0	1	LVTTL	
9	/RAS access time	-A60	3CH	0	0	1	1	1	1	0	0	60 ns
		-A70	46H	0	0	1	0	0	1	1	0	70 ns
10	/CAS access time	-A60	11H	0	0	0	1	0	0	0	1	17 ns
		-A70	14H	0	0	0	1	0	1	0	0	20 ns
11	Error detection/correction	00H	0	0	0	0	0	0	0	0	None	
12	Refresh period	00H	0	0	0	0	0	0	0	0	Normal	
13	DRAM width	04H	0	0	0	0	0	1	0	0	×4	
14	Error checking DRAM width	00H	0	0	0	0	0	0	0	0	None	
15 - 61		00H	0	0	0	0	0	0	0	0	None	
62	SPD revision	01H	0	0	0	0	0	0	0	1	1	
63	Checksum for bytes 0 - 62	-A60	11H	0	0	0	1	0	0	0	1	
		-A70	1EH	0	0	0	1	1	1	1	0	
64	Manufacture's JEDEC ID code per JEP-106E	10H	0	0	0	1	0	0	0	0		
65-71		00H	0	0	0	0	0	0	0	0		
72	Manufacturing location											
73	Part name	34H	0	0	1	1	0	1	0	0		
74	Part name	32H	0	0	1	1	0	0	1	0		
75	Part name	34H	0	0	1	1	0	1	0	0		
76	Part name	4CH	0	1	0	0	1	1	0	0		
77	Part name	46H	0	1	0	0	0	1	1	0		
78	Part name	47H	0	1	0	0	0	1	1	1		
79	Part name	36H	0	0	1	1	0	1	1	0		
80	Part name	34H	0	0	1	1	0	1	0	0		
81	Part name	31H	0	0	1	1	0	0	0	1		
82	Part name	46H	0	1	0	0	0	1	1	0		
83	Part name	2DH	0	0	1	0	1	1	0	1		
84	Part name	41H	0	1	0	0	0	0	0	1		
85	Part name	-A60	36H	0	0	1	1	0	1	1	0	
		-A70	37H	0	0	1	1	0	1	1	1	
86	Part name	30H	0	0	1	1	0	0	0	0		
87	Part name	20H	0	0	1	0	0	0	0	0		
88	Part name	20H	0	0	1	0	0	0	0	0		
89	Part name	20H	0	0	1	0	0	0	0	0		
90	Part name	20H	0	0	1	0	0	0	0	0		
91	PCB revision code	31H	0	0	1	1	0	0	0	1		
92	Blank	20H	0	0	1	0	0	0	0	0		

Remark 1 : High level (Serial data), 0 : Low level (Serial data)

[MC-424LFG641FA]

Byte No.	Function Described	Hex	Bit 7	Bit 6	Bit 5	Bit 4	Bit 3	Bit 2	Bit 1	Bit 0	Notes	
0	Number of serial PD bytes	5DH	0	1	0	1	1	1	0	1	93 bytes	
1	Serial memory	08H	0	0	0	0	1	0	0	0	256 bytes	
2	Fundamental memory type	02H	0	0	0	0	0	0	1	0	EDO	
3	Number of rows	0CH	0	0	0	0	1	1	0	0	12 rows	
4	Number of columns	0AH	0	0	0	0	1	0	1	0	10 columns	
5	Number of banks	01H	0	0	0	0	0	0	0	1	1 bank	
6	Data width	40H	0	1	0	0	0	0	0	0	64 bits	
7	Data width (continued)	00H	0	0	0	0	0	0	0	0	0	
8	Voltage interface	01H	0	0	0	0	0	0	0	1	LVTTTL	
9	/RAS access time	-A60	3CH	0	0	1	1	1	1	0	0	60 ns
		-A70	46H	0	1	0	0	0	1	1	0	70 ns
10	/CAS access time	-A60	11H	0	0	0	1	0	0	0	1	17 ns
		-A70	14H	0	0	1	0	0	1	0	0	20 ns
11	Error detection/correction	00H	0	0	0	0	0	0	0	0	None	
12	Refresh period	00H	0	0	0	0	0	0	0	0	Normal	
13	DRAM width	04H	0	0	0	0	0	1	0	0	×4	
14	Error checking DRAM width	00H	0	0	0	0	0	0	0	0	None	
15 - 61		00H	0	0	0	0	0	0	0	0	None	
62	SPD revision	01H	0	0	0	0	0	0	0	1	1	
63	Checksum for bytes 0 - 62	-A60	11H	0	0	0	1	0	0	0	1	
		-A70	1EH	0	0	0	1	1	1	1	0	
64	Manufacture's JEDEC ID code per JEP-106E	10H	0	0	0	1	0	0	0	0		
65-71		00H	0	0	0	0	0	0	0	0		
72	Manufacturing location											
73	Part name	34H	0	0	1	1	0	1	0	0		
74	Part name	32H	0	0	1	1	0	0	1	0		
75	Part name	34H	0	0	1	1	0	1	0	0		
76	Part name	4CH	0	1	0	0	1	1	0	0		
77	Part name	46H	0	1	0	0	0	1	1	0		
78	Part name	47H	0	1	0	0	0	1	1	1		
79	Part name	36H	0	0	1	1	0	1	1	0		
80	Part name	34H	0	0	1	1	0	1	0	0		
81	Part name	31H	0	0	1	1	0	0	0	1		
82	Part name	46H	0	1	0	0	0	1	1	0		
83	Part name	41H	0	1	0	0	0	0	0	1		
84	Part name	2DH	0	0	1	0	1	1	0	1		
85	Part name	41H	0	1	0	0	0	0	0	1		
86	Part name	-A60	36H	0	0	1	1	0	1	1	0	
		-A70	37H	0	0	1	1	0	1	1	1	
87	Part name	30H	0	0	1	1	0	0	0	0		
88	Part name	20H	0	0	1	0	0	0	0	0		
89	Part name	20H	0	0	1	0	0	0	0	0		
90	Part name	20H	0	0	1	0	0	0	0	0		
91	PCB revision code	31H	0	0	1	1	0	0	0	1		
92	Blank	20H	0	0	1	0	0	0	0	0		

Remark 1 : High level (Serial data), 0 : Low level (Serial data)

[MC-424LFG641FW]

Byte No.	Function Described	Hex	Bit 7	Bit 6	Bit 5	Bit 4	Bit 3	Bit 2	Bit 1	Bit 0	Notes	
0	Number of serial PD bytes	5DH	0	1	0	1	1	1	0	1	93 bytes	
1	Serial memory	08H	0	0	0	0	1	0	0	0	256 bytes	
2	Fundamental memory type	02H	0	0	0	0	0	0	1	0	EDO	
3	Number of rows	0CH	0	0	0	0	1	1	0	0	12 rows	
4	Number of columns	0AH	0	0	0	0	1	0	1	0	10 columns	
5	Number of banks	01H	0	0	0	0	0	0	0	1	1 bank	
6	Data width	40H	0	1	0	0	0	0	0	0	64 bits	
7	Data width (continued)	00H	0	0	0	0	0	0	0	0	0	
8	Voltage interface	01H	0	0	0	0	0	0	0	1	LVTTTL	
9	/RAS access time	-A50	32H	0	0	1	1	0	0	1	0	50 ns
		-A60	3CH	0	0	1	1	1	1	0	0	60 ns
10	/CAS access time	-A50	0DH	0	0	0	0	1	1	0	1	13 ns
		-A60	0FH	0	0	0	0	1	1	1	1	15 ns
11	Error detection/correction	00H	0	0	0	0	0	0	0	0	None	
12	Refresh period	00H	0	0	0	0	0	0	0	0	Normal	
13	DRAM width	10H	0	0	0	1	0	0	0	0	×16	
14	Error checking DRAM width	00H	0	0	0	0	0	0	0	0	None	
15 - 61		00H	0	0	0	0	0	0	0	0	None	
62	SPD revision	01H	0	0	0	0	0	0	0	1	1	
63	Checksum for bytes 0 - 62	-A50	03H	0	0	0	0	0	0	1	1	
		-A60	0FH	0	0	0	0	1	1	1	1	
64	Manufacture's JEDEC ID code per JEP-106E	10H	0	0	0	1	0	0	0	0		
65-71		00H	0	0	0	0	0	0	0	0		
72	Manufacturing location											
73	Part name	34H	0	0	1	1	0	1	0	0		
74	Part name	32H	0	0	1	1	0	0	1	0		
75	Part name	34H	0	0	1	1	0	1	0	0		
76	Part name	4CH	0	1	0	0	1	1	0	0		
77	Part name	46H	0	1	0	0	0	1	1	0		
78	Part name	47H	0	1	0	0	0	1	1	1		
79	Part name	36H	0	0	1	1	0	1	1	0		
80	Part name	34H	0	0	1	1	0	1	0	0		
81	Part name	31H	0	0	1	1	0	0	0	1		
82	Part name	46H	0	1	0	0	0	1	1	0		
83	Part name	57H	0	1	0	1	0	1	1	1		
84	Part name	2DH	0	0	1	0	1	1	0	1		
85	Part name	41H	0	1	0	0	0	0	0	1		
86	Part name	-A50	35H	0	0	1	1	0	1	0	1	
		-A60	36H	0	0	1	1	0	1	1	0	
87	Part name	30H	0	0	1	1	0	0	0	0		
88	Part name	20H	0	0	1	0	0	0	0	0		
89	Part name	20H	0	0	1	0	0	0	0	0		
90	Part name	20H	0	0	1	0	0	0	0	0		
91	PCB revision code	31H	0	0	1	1	0	0	0	1		
92	Blank	20H	0	0	1	0	0	0	0	0		

Remark 1 : High level (Serial data), 0 : Low level (Serial data)

Read Cycle

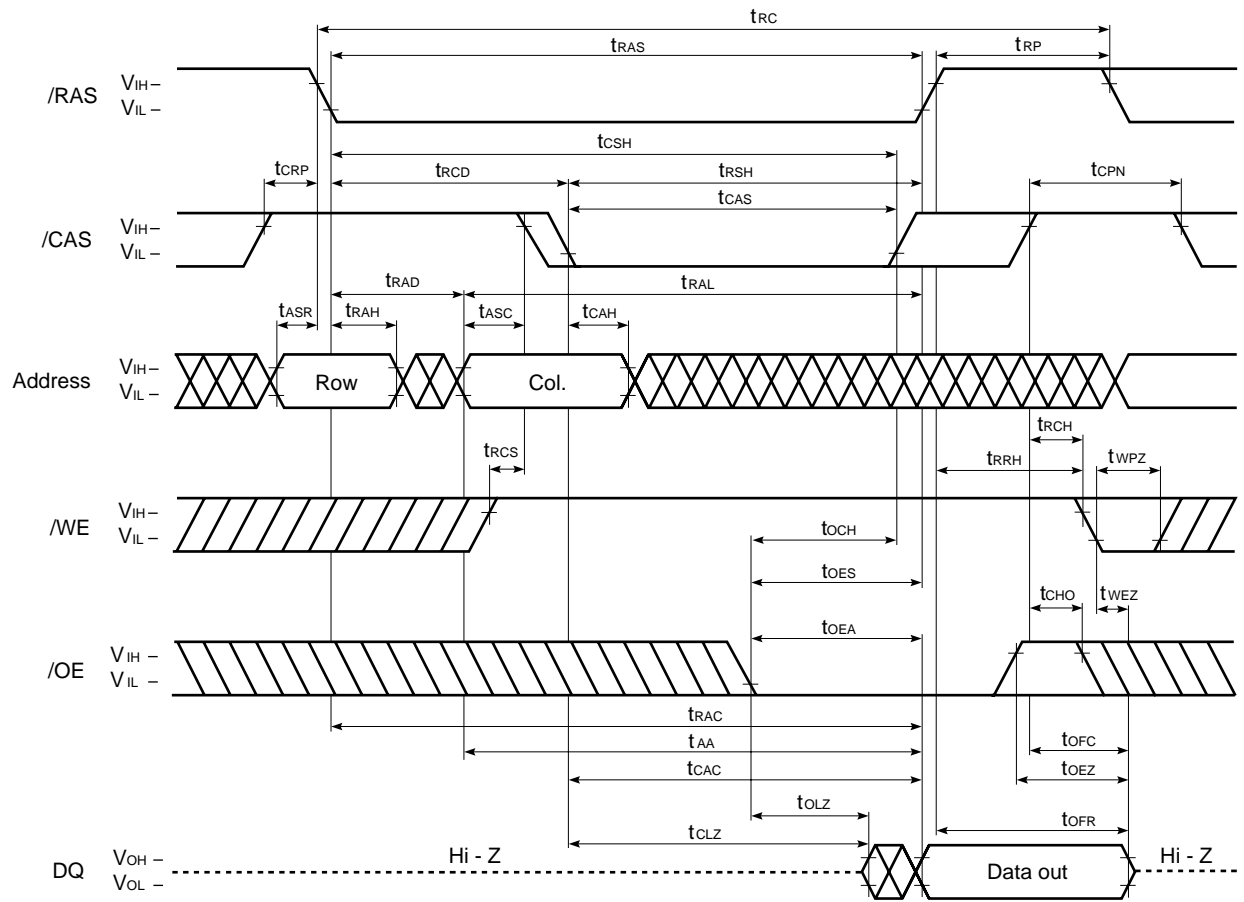

Early Write Cycle

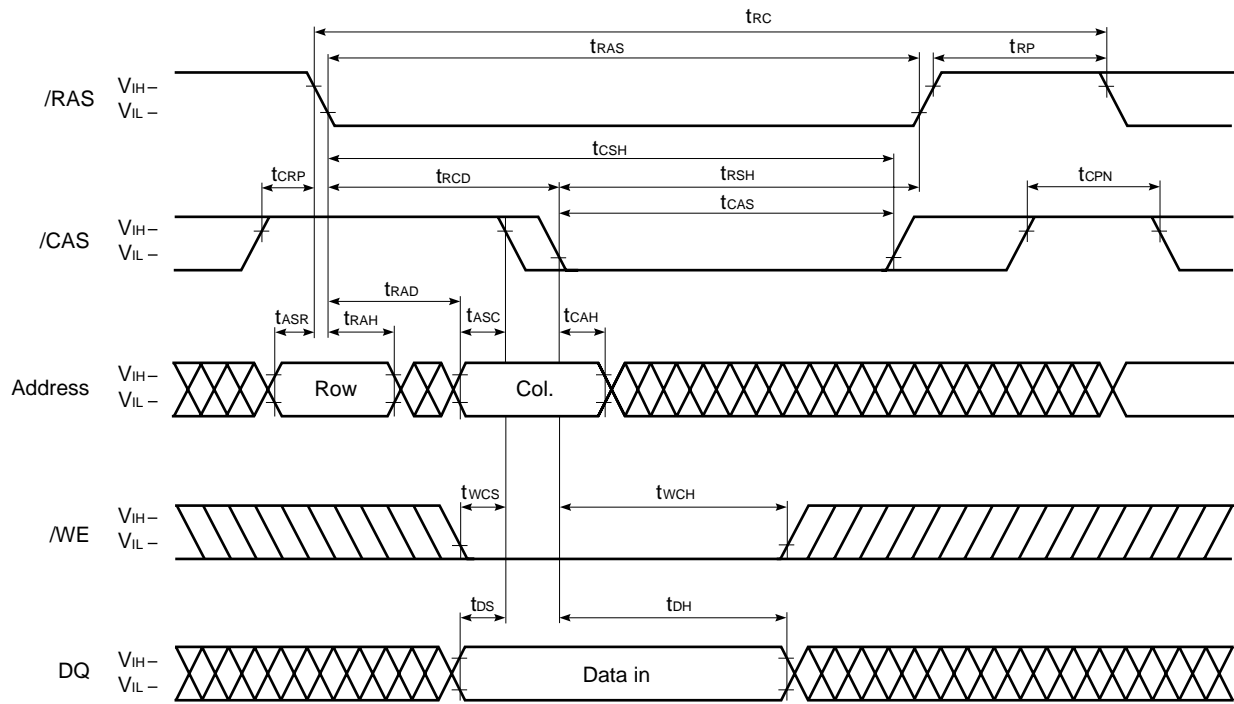

Remark /OE : Don't care

Late Write Cycle

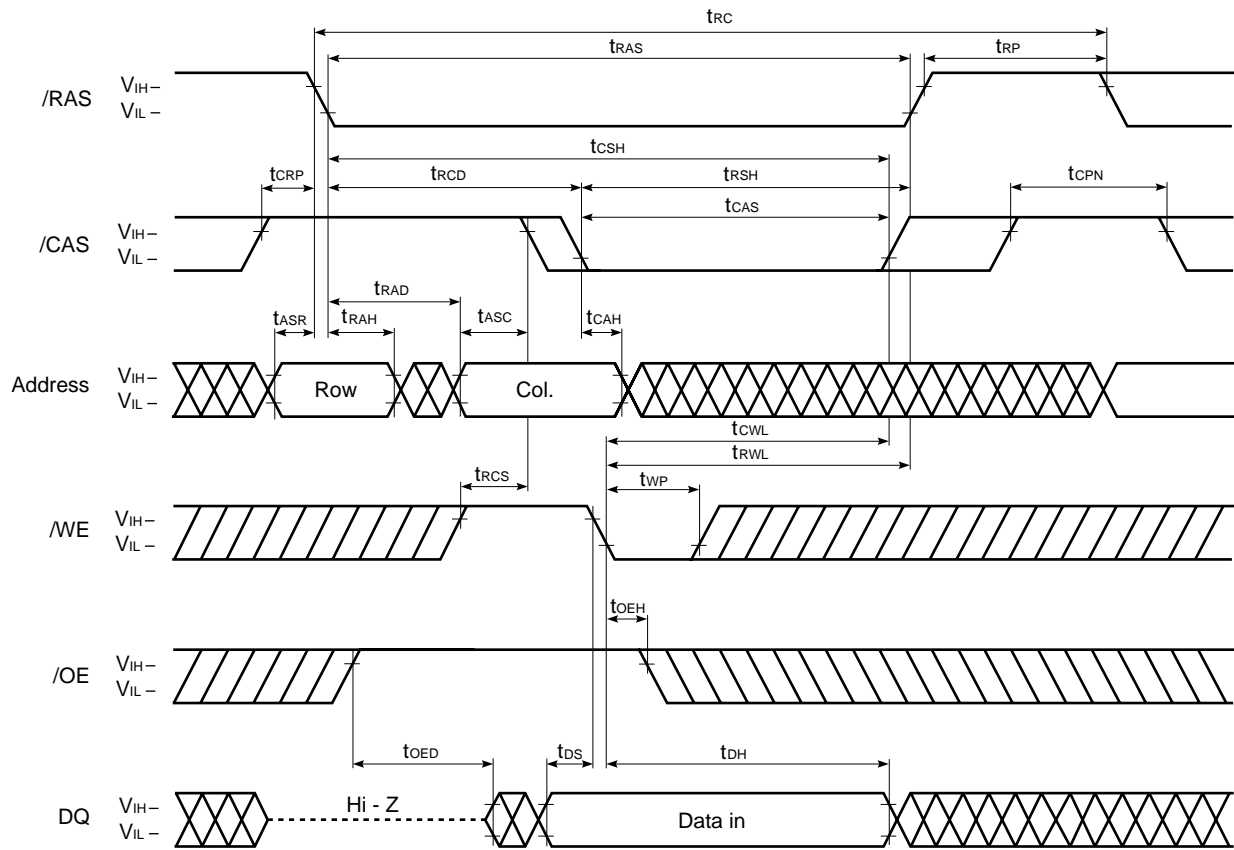

Read Modify Write Cycle

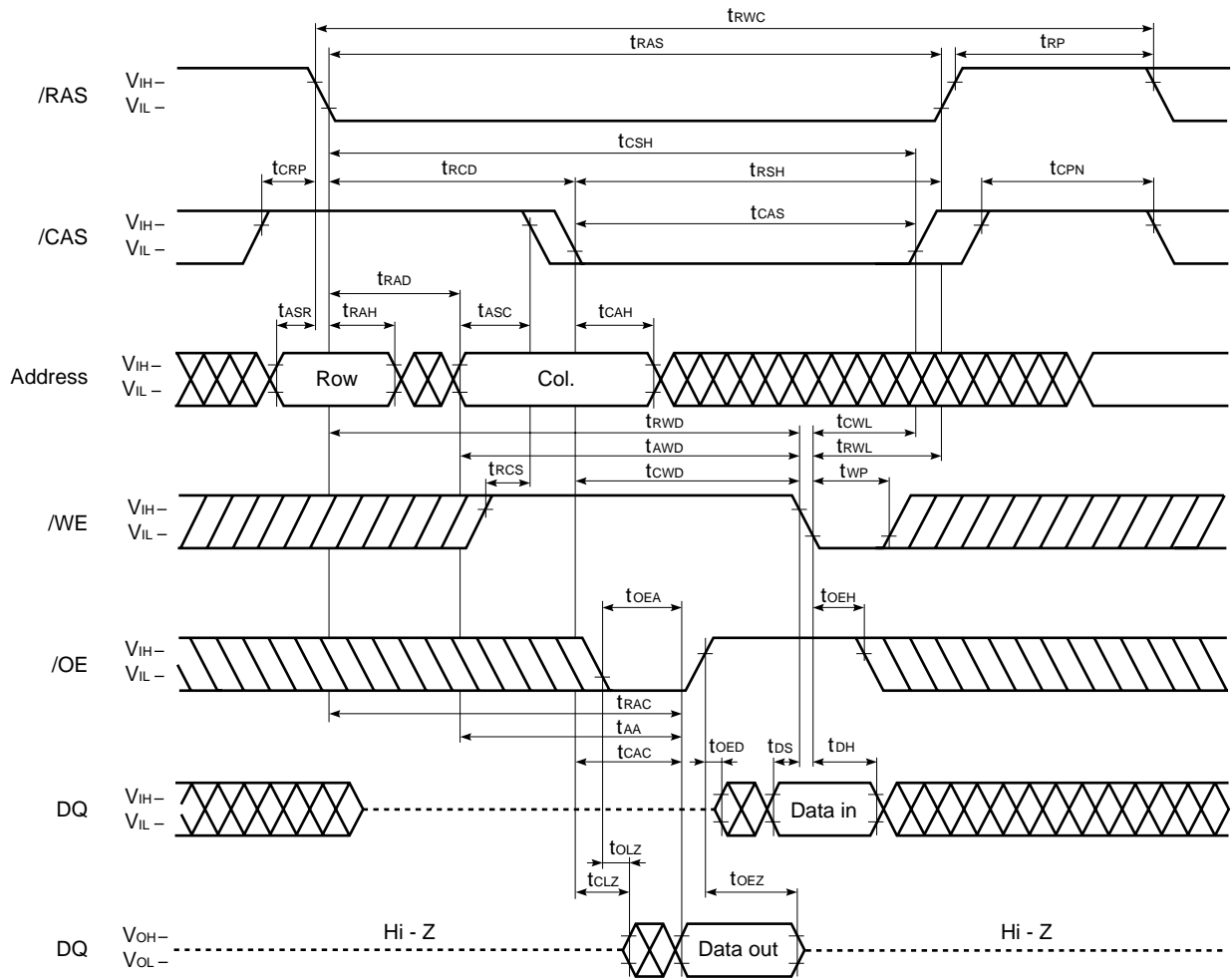

Hyper Page Mode (EDO) Read Cycle (/WE Control)

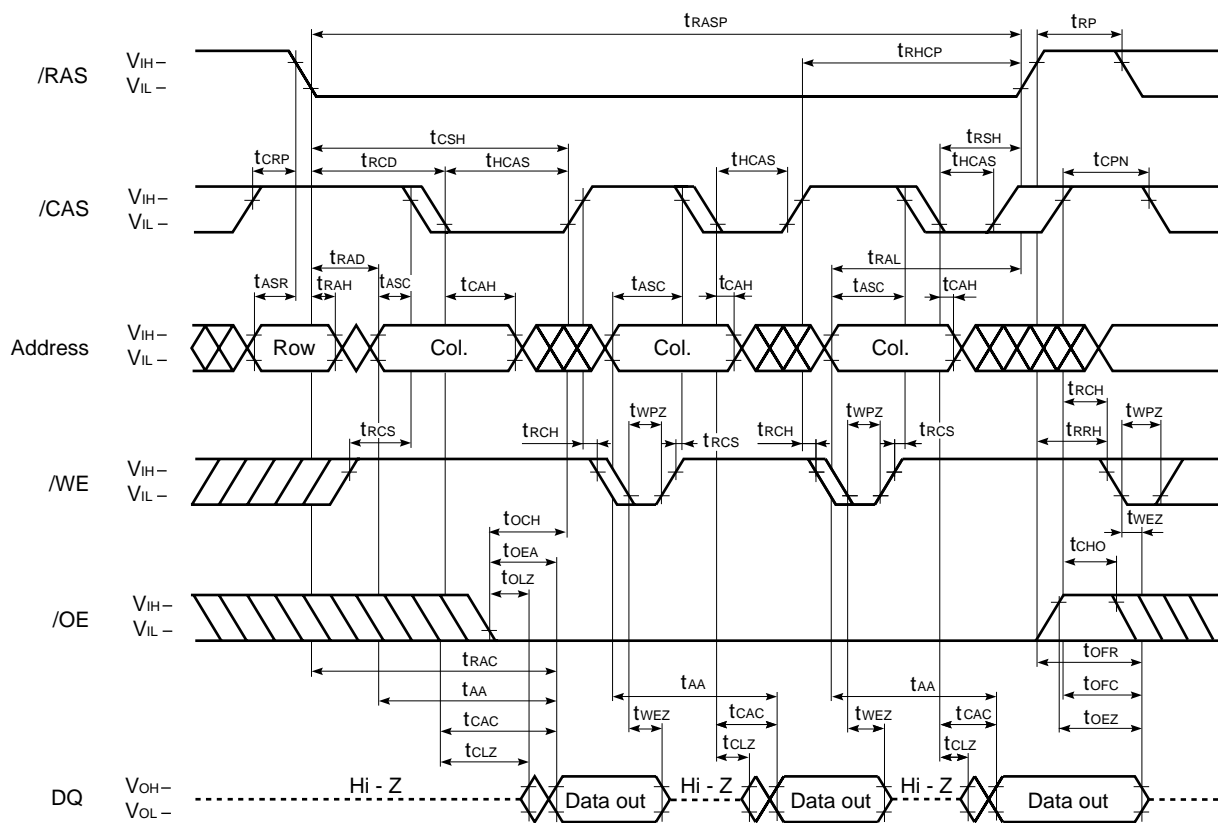

Remark In the hyper page mode (EDO), read, write and read modify write cycles are available for each of the consecutive /CAS cycles within the same /RAS cycle.

Hyper Page Mode (EDO) Early Write Cycle

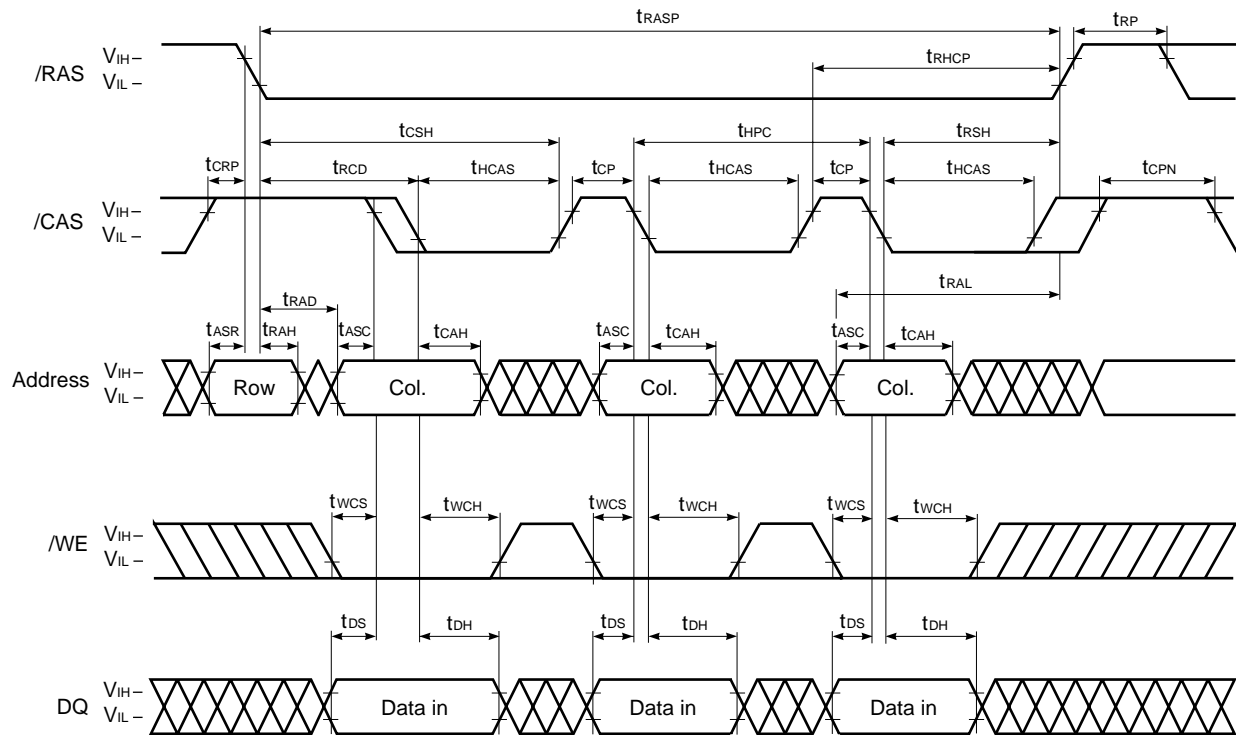

Remarks 1. /OE : Don't care

2. In the hyper page mode (EDO), read, write and read modify write cycles are available for each of the consecutive /CAS cycles within the same /RAS cycle.

Hyper Page Mode (EDO) Late Write Cycle

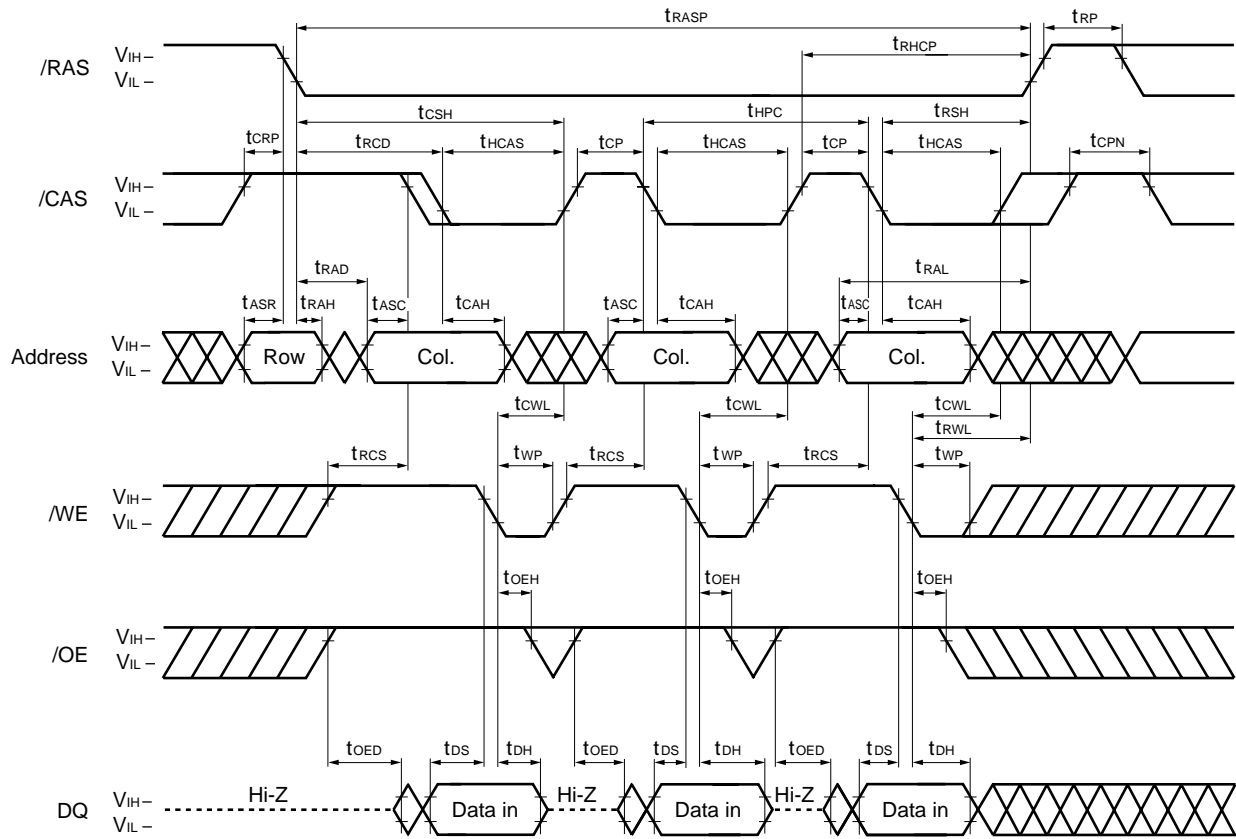

Remark In the hyper page mode (EDO), read, write and read modify write cycles are available for each of the consecutive /CAS cycles within the same /RAS cycle.

Hyper Page Mode (EDO) Read and Write Cycle

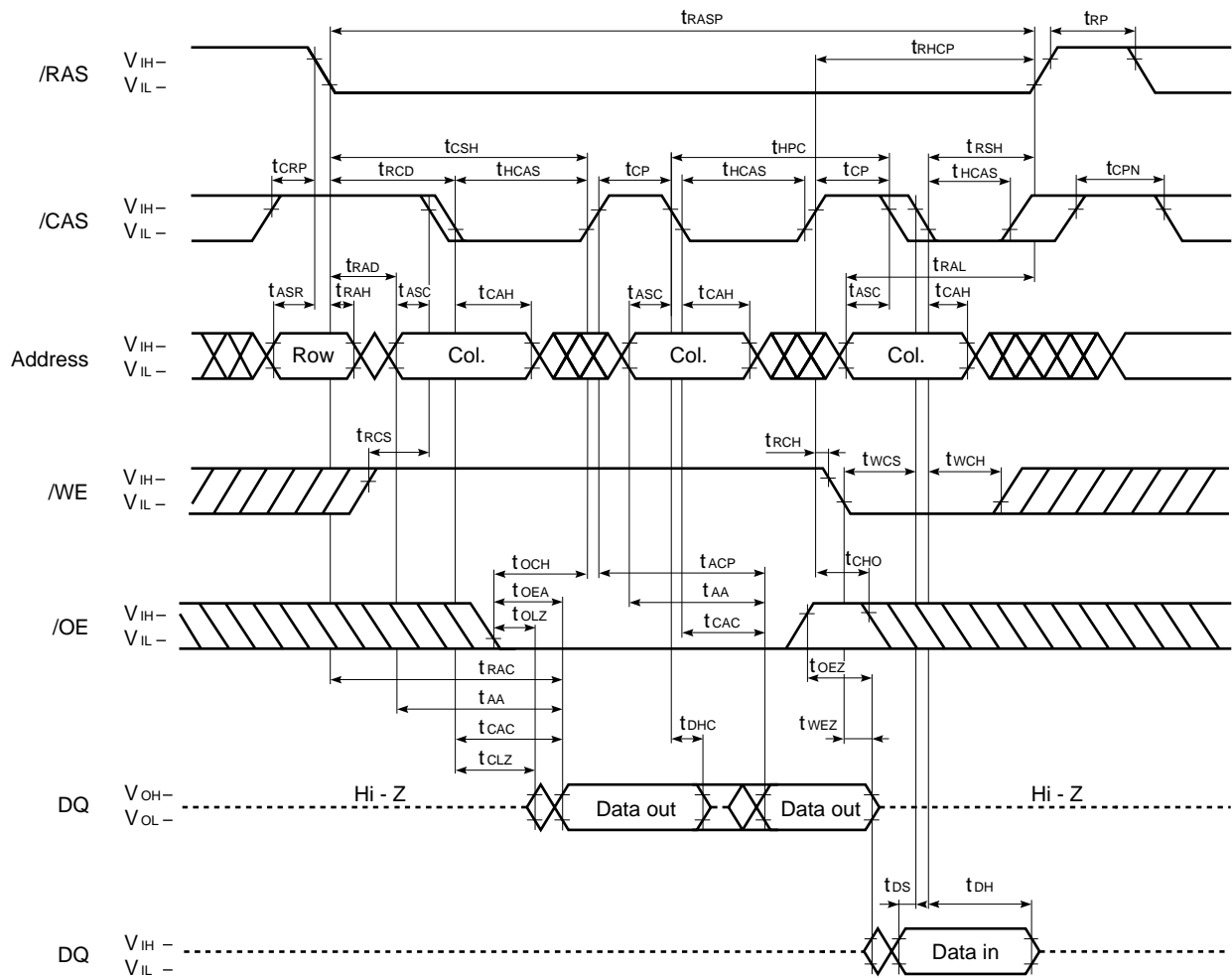

Remark In the hyper page mode (EDO), read, write and read modify write cycles are available for each of the consecutive /CAS cycles within the same /RAS cycle.

/CAS Before /RAS Refresh Cycle

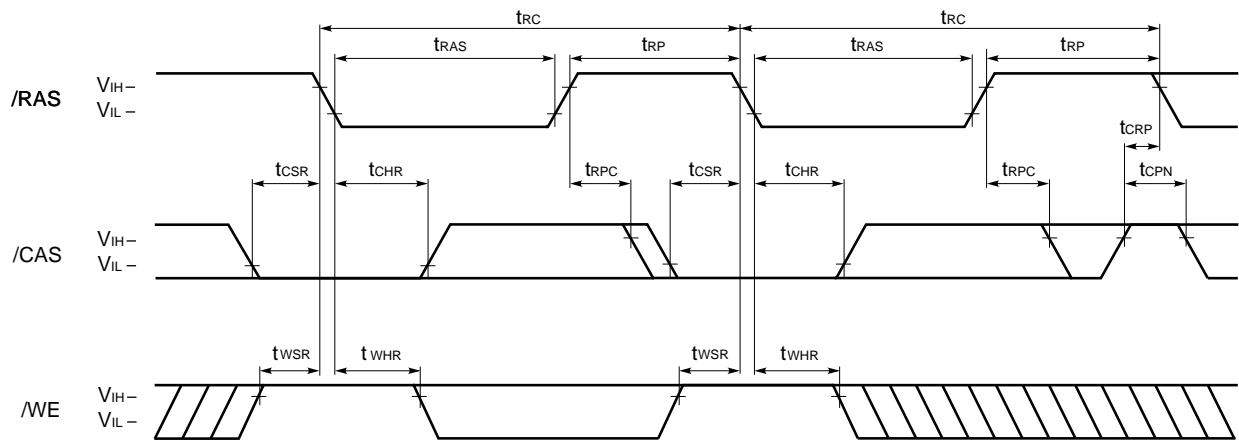

Remark Address, /OE : Don't care DQ : Hi-Z

/RAS Only Refresh Cycle

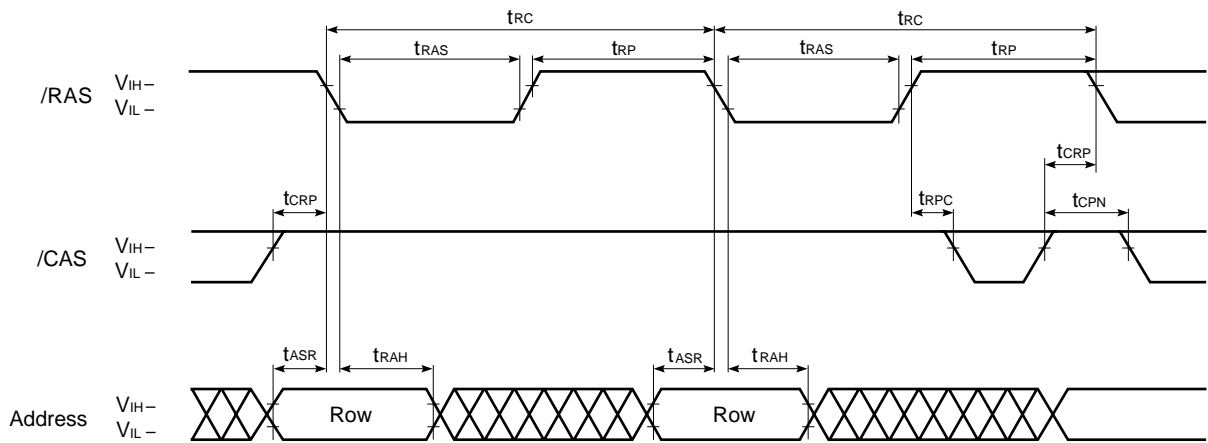

Remark /WE, /OE : Don't care DQ : Hi-Z

Hidden Refresh Cycle (Read)

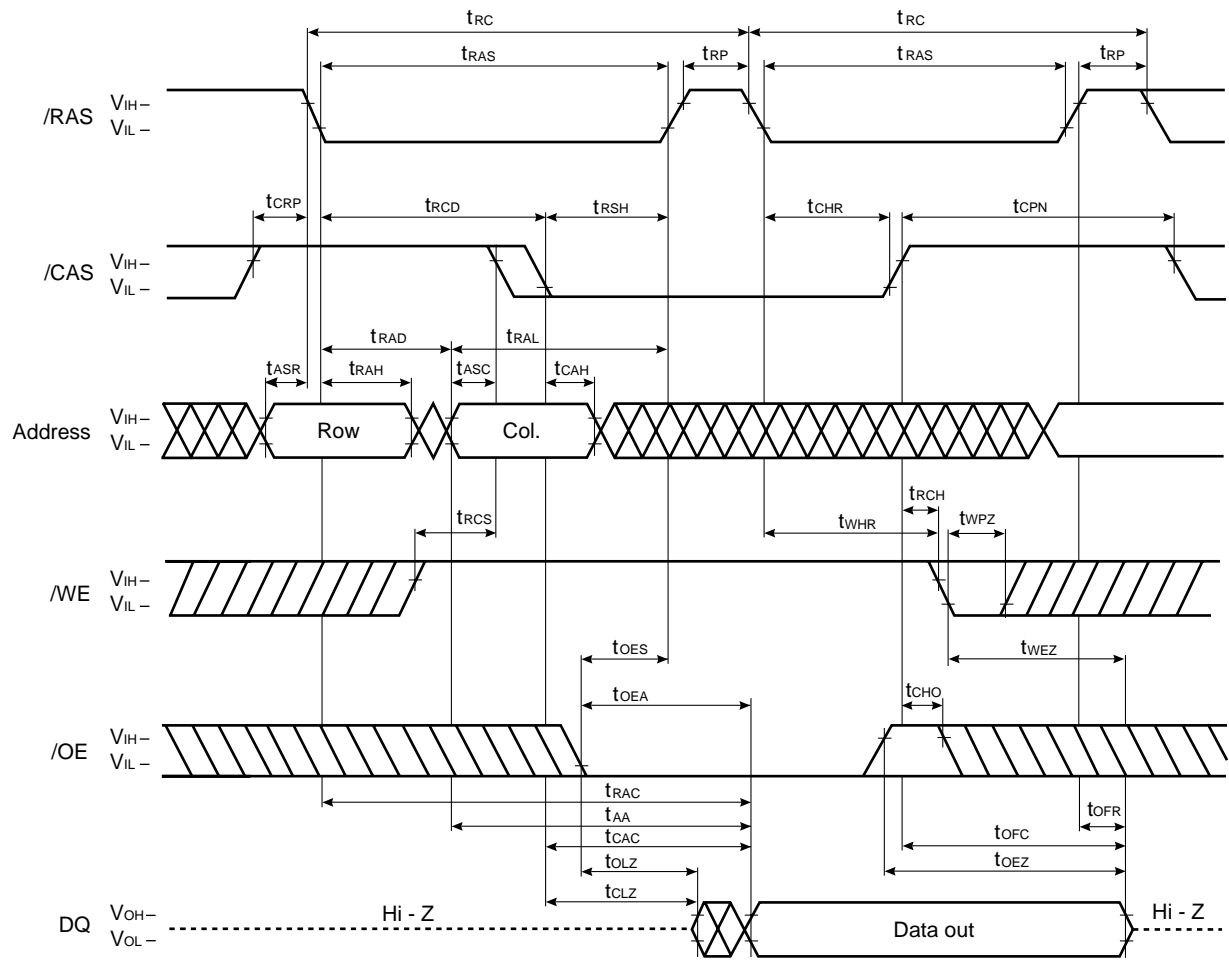

Hidden Refresh Cycle (Write)

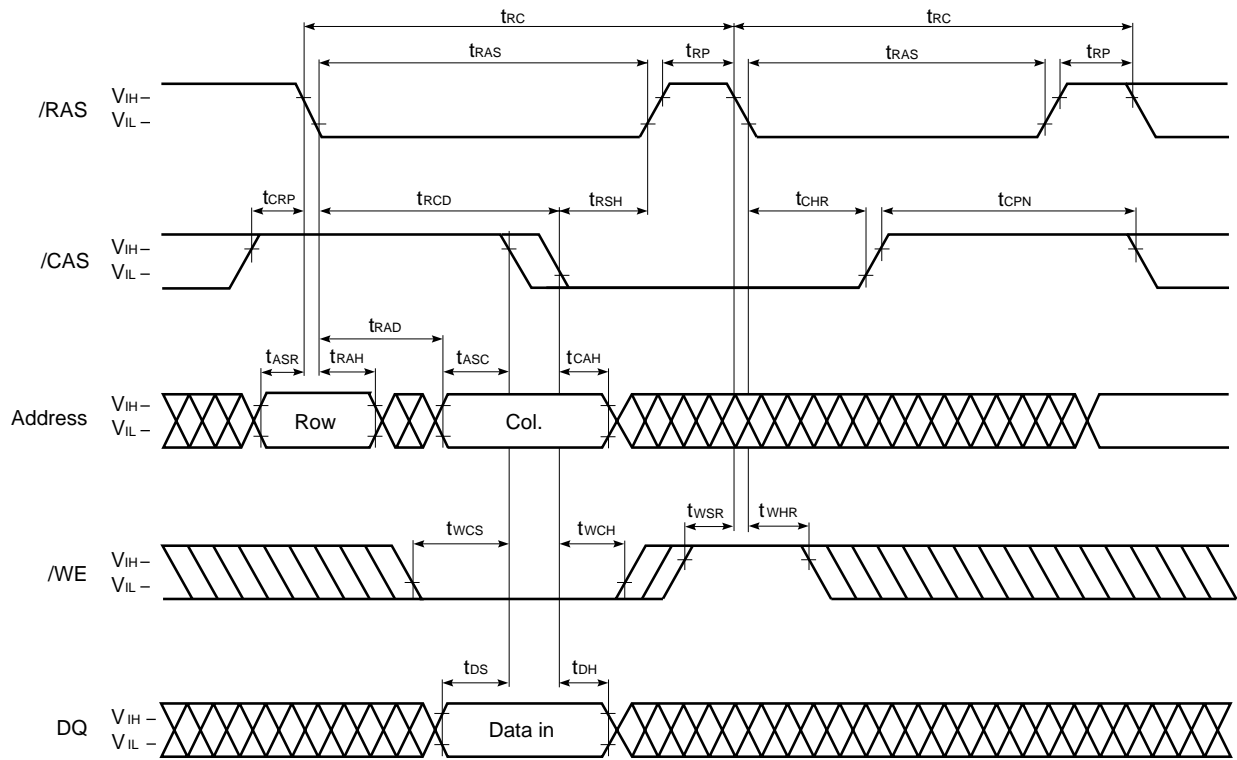

Remark /OE : Don't care

Package Drawings

[MC-424LFG641F]

168 PIN DUAL IN-LINE MODULE (SOCKET TYPE)

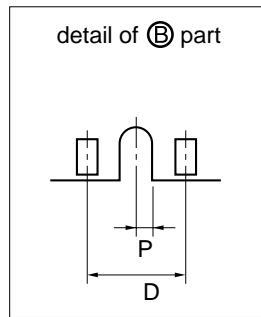
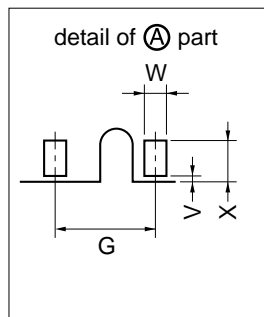
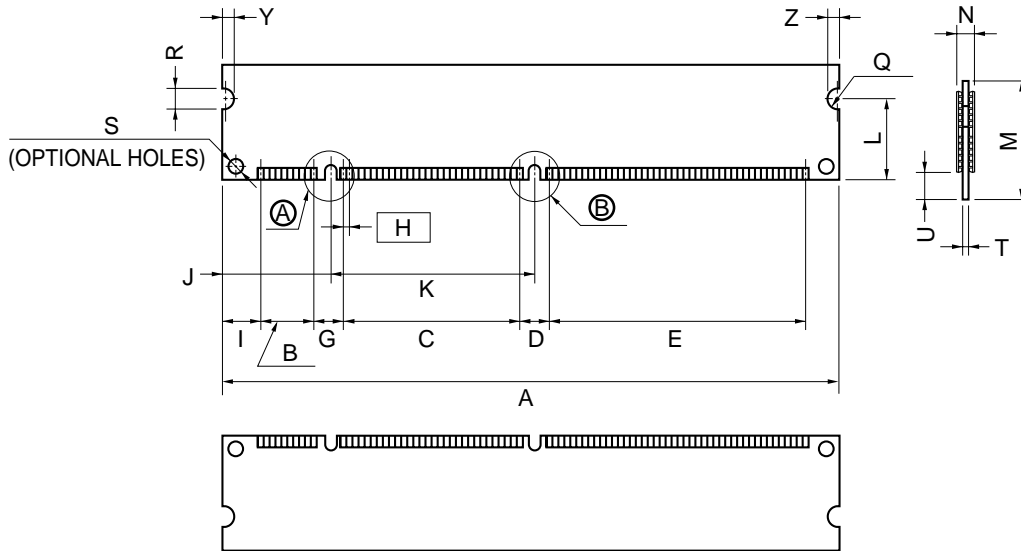

UB3PD

ITEM	MILLIMETERS	INCHES
A	133.35±0.13	5.250±0.006
B	11.43	0.450
C	36.83	1.450
D	6.35	0.250
E	54.61	2.150
G	6.35	0.250
H	1.27 (T.P.)	0.050 (T.P.)
I	8.89	0.350
J	24.495	0.964
K	42.18	1.661
L	17.78	0.700
M	25.40	1.000
N	4.0 MAX.	0.158 MAX.
P	1.0	0.039
Q	R2.0	R0.079
R	4.0±0.1	0.157 ^{+0.005} _{-0.004}
S	φ3.0	φ0.118
T	1.27±0.1	0.05±0.004
U	4.0 MIN.	0.157 MIN.
V	0.25 MAX.	0.010 MAX.
W	1.0±0.05	0.039 ^{+0.003} _{-0.002}
X	2.54 MIN.	0.100±0.004
Y	3.0 MIN.	0.118 MIN.
Z	3.0 MIN.	0.118 MIN.

[MC-424LFG641FA]

168 PIN DUAL IN-LINE MODULE (SOCKET TYPE)

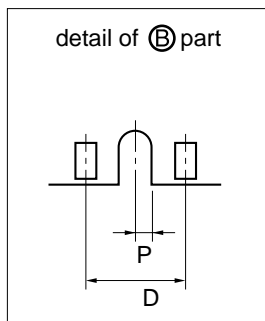
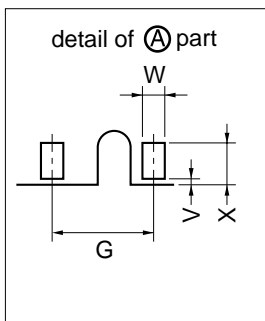
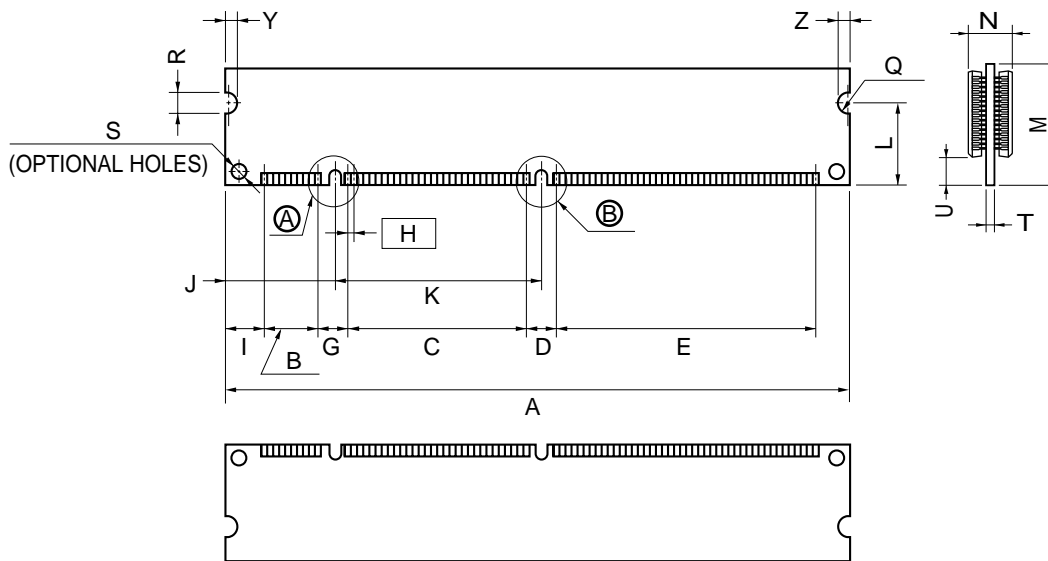

UB3JD

ITEM	MILLIMETERS	INCHES
A	133.35±0.13	5.250±0.006
B	11.43	0.450
C	36.83	1.450
D	6.35	0.250
E	54.61	2.150
G	6.35	0.250
H	1.27 (T.P.)	0.050 (T.P.)
I	8.89	0.350
J	24.495	0.964
K	42.18	1.661
L	17.78	0.700
M	25.40	1.000
N	9.0 MAX.	0.355 MAX.
P	1.0	0.039
Q	R2.0	R0.079
R	4.0±0.1	0.157 ^{+0.005} _{-0.004}
S	φ3.0	φ0.118
T	1.27±0.1	0.05±0.004
U	4.0 MIN.	0.157 MIN.
V	0.25 MAX.	0.010 MAX.
W	1.0±0.05	0.039 ^{+0.003} _{-0.002}
X	2.54 MIN.	0.100±0.004
Y	3.0 MIN.	0.118 MIN.
Z	3.0 MIN.	0.118 MIN.

★ [MC-424LFG641FW]

168 PIN DUAL IN-LINE MODULE (SOCKET TYPE)

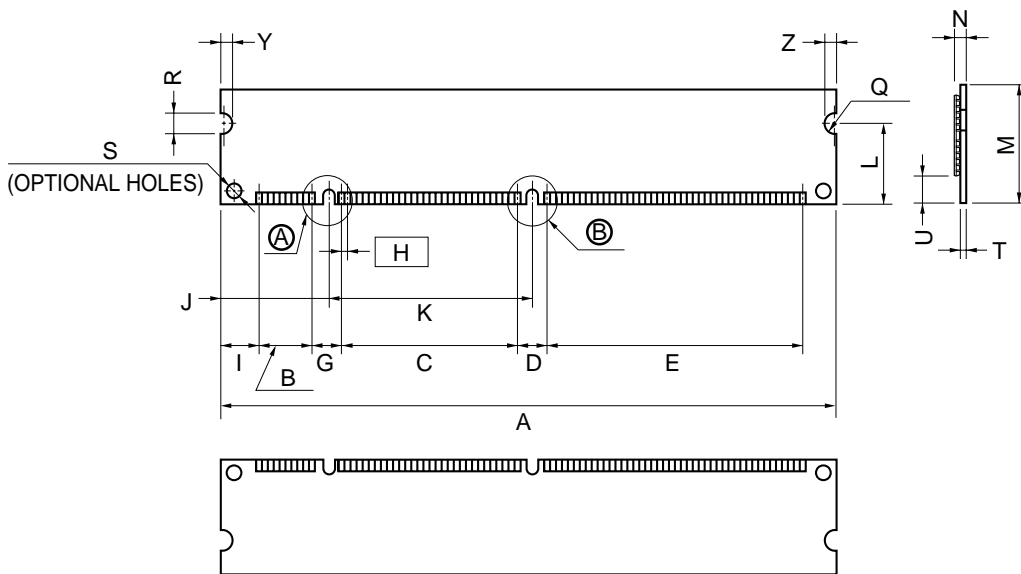

UB3PS-1

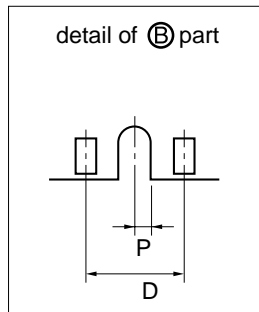
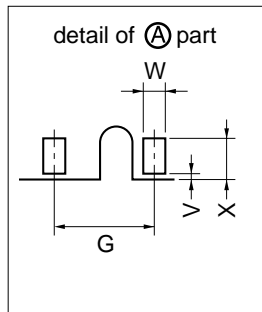

ITEM	MILLIMETERS	INCHES
A	133.35±0.13	5.250±0.006
B	11.43	0.450
C	36.83	1.450
D	6.35	0.250
E	54.61	2.150
G	6.35	0.250
H	1.27 (T.P.)	0.050 (T.P.)
I	8.89	0.350
J	24.495	0.964
K	42.18	1.661
L	17.78	0.700
M	25.40	1.000
N	3.00 MAX.	0.118 MAX.
P	1.0	0.039
Q	R2.0	R0.079
R	4.0±0.1	0.157 ^{+0.005} _{-0.004}
S	φ3.0	φ0.118
T	1.27±0.1	0.05±0.004
U	4.0 MIN.	0.157 MIN.
V	0.25 MAX.	0.010 MAX.
W	1.0±0.05	0.039 ^{+0.003} _{-0.002}
X	2.54 MIN.	0.100±0.004
Y	3.0 MIN.	0.118 MIN.
Z	3.0 MIN.	0.118 MIN.

[MEMO]

[MEMO]

[MEMO]

NOTES FOR CMOS DEVICES

① PRECAUTION AGAINST ESD FOR SEMICONDUCTORS

Note: Strong electric field, when exposed to a MOS device, can cause destruction of the gate oxide and ultimately degrade the device operation. Steps must be taken to stop generation of static electricity as much as possible, and quickly dissipate it once, when it has occurred. Environmental control must be adequate. When it is dry, humidifier should be used. It is recommended to avoid using insulators that easily build static electricity. Semiconductor devices must be stored and transported in an anti-static container, static shielding bag or conductive material. All test and measurement tools including work bench and floor should be grounded. The operator should be grounded using wrist strap. Semiconductor devices must not be touched with bare hands. Similar precautions need to be taken for PW boards with semiconductor devices on it.

② HANDLING OF UNUSED INPUT PINS FOR CMOS

Note: No connection for CMOS device inputs can be cause of malfunction. If no connection is provided to the input pins, it is possible that an internal input level may be generated due to noise, etc., hence causing malfunction. CMOS device behave differently than Bipolar or NMOS devices. Input levels of CMOS devices must be fixed high or low by using a pull-up or pull-down circuitry. Each unused pin should be connected to V_{DD} or GND with a resistor, if it is considered to have a possibility of being an output pin. All handling related to the unused pins must be judged device by device and related specifications governing the devices.

③ STATUS BEFORE INITIALIZATION OF MOS DEVICES

Note: Power-on does not necessarily define initial status of MOS device. Production process of MOS does not define the initial operation status of the device. Immediately after the power source is turned ON, the devices with reset function have not yet been initialized. Hence, power-on does not guarantee out-pin levels, I/O settings or contents of registers. Device is not initialized until the reset signal is received. Reset operation must be executed immediately after power-on for devices having reset function.

[MEMO]

CAUTION FOR HANDLING MEMORY MODULES

When handling or inserting memory modules, be sure not to touch any components on the modules, such as the memory IC, chip capacitors and chip resistors. It is necessary to avoid undue mechanical stress on these components to prevent damaging them.

When re-packing memory modules, be sure the modules are NOT touching each other. Modules in contact with other modules may cause excessive mechanical stress, which may damage the modules.

No part of this document may be copied or reproduced in any form or by any means without the prior written consent of NEC Corporation. NEC Corporation assumes no responsibility for any errors which may appear in this document.

NEC Corporation does not assume any liability for infringement of patents, copyrights or other intellectual property rights of third parties by or arising from use of a device described herein or any other liability arising from use of such device. No license, either express, implied or otherwise, is granted under any patents, copyrights or other intellectual property rights of NEC Corporation or others.

While NEC Corporation has been making continuous effort to enhance the reliability of its semiconductor devices, the possibility of defects cannot be eliminated entirely. To minimize risks of damage or injury to persons or property arising from a defect in an NEC semiconductor device, customers must incorporate sufficient safety measures in its design, such as redundancy, fire-containment, and anti-failure features.

NEC devices are classified into the following three quality grades:

"Standard", "Special", and "Specific". The Specific quality grade applies only to devices developed based on a customer designated "quality assurance program" for a specific application. The recommended applications of a device depend on its quality grade, as indicated below. Customers must check the quality grade of each device before using it in a particular application.

Standard: Computers, office equipment, communications equipment, test and measurement equipment, audio and visual equipment, home electronic appliances, machine tools, personal electronic equipment and industrial robots

Special: Transportation equipment (automobiles, trains, ships, etc.), traffic control systems, anti-disaster systems, anti-crime systems, safety equipment and medical equipment (not specifically designed for life support)

Specific: Aircrafts, aerospace equipment, submersible repeaters, nuclear reactor control systems, life support systems or medical equipment for life support, etc.

The quality grade of NEC devices is "Standard" unless otherwise specified in NEC's Data Sheets or Data Books. If customers intend to use NEC devices for applications other than those specified for Standard quality grade, they should contact an NEC sales representative in advance.

Anti-radioactive design is not implemented in this product.