

54ABT240 Octal Buffer/Line Driver with TRI-STATE® Outputs

General Description

The 'ABT240 is an inverting octal buffer and line driver designed to be employed as a memory address driver, clock driver and bus oriented transmitter or receiver which provides improved PC board density.

- Guaranteed latching protection
- High impedance glitch free bus loading during entire power up and power down cycle
- Nondestructive hot insertion capability
- Standard Microcircuit Drawing (SMD)—5962-9318801

Features

- Output sink capability of 48 mA, source capability of 24 mA

Ordering Code

Military	Package Number	Package Description
54ABT240J-QML	J20A	20-Lead Ceramic Dual-In-Line
54ABT240W-QML	W20A	20-Lead Cerpack
54ABT240E-QML	E20A	20-Lead Ceramic Leadless Chip Carrier, Type C

Connection Diagrams

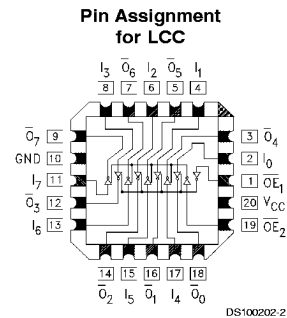
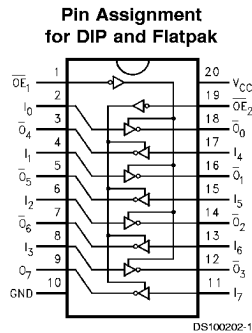

Pin Names	Description
$\overline{OE}_1, \overline{OE}_2$	TRI-STATE Output Enable Inputs
I_0-I_7	Inputs
$\overline{O}_0-\overline{O}_7$	Outputs

TRI-STATE® is a registered trademark of National Semiconductor Corporation.

Truth Tables

Inputs		Outputs (Pins 12, 14, 16, 18)
\overline{OE}_1	I_n	
L	L	H
L	H	L
H	X	Z

Inputs		Outputs (Pins 3, 5, 7, 9)
\overline{OE}_2	I_n	
L	L	H
L	H	L
H	X	Z

H = HIGH Voltage Level
L = LOW Voltage Level
X = Immaterial
Z = High Impedance

Absolute Maximum Ratings (Note 1)

If Military/Aerospace specified devices are required, please contact the National Semiconductor Sales Office/ Distributors for availability and specifications.

Storage Temperature	-65°C to +150°C
Ambient Temperature under Bias	-55°C to +125°C
Junction Temperature under Bias	
Ceramic	-55°C to +175°C
V _{CC} Pin Potential to Ground Pin	-0.5V to +7.0V
Input Voltage (Note 2)	-0.5V to +7.0V
Input Current (Note 2)	-30 mA to +5.0 mA
Voltage Applied to Any Output in the Disabled or Power-Off State	-0.5V to 5.5V
in the HIGH State	-0.5V to V _{CC}

Current Applied to Output in LOW State (Max)	twice the rated I _{OL} (mA)
DC Latchup Source Current (Across Comm Operating Range)	-150 mA
Over Voltage Latchup (I/O)	10V

Recommended Operating Conditions

Free Air Ambient Temperature	
Military	-55°C to +125°C
Supply Voltage	
Military	+4.5V to +5.5V
Minimum Input Edge Rate (ΔV/Δt)	
Data Input	50 mV/ns
Enable Input	20 mV/ns

Note 1: Absolute maximum ratings are values beyond which the device may be damaged or have its useful life impaired. Functional operation under these conditions is not implied.

Note 2: Either voltage limit or current limit is sufficient to protect inputs.

DC Electrical Characteristics

Symbol	Parameter	ABT240			Units	V _{CC}	Conditions
		Min	Typ	Max			
V _{IH}	Input HIGH Voltage	2.0			V		Recognized HIGH Signal
V _{IL}	Input LOW Voltage			0.8	V		Recognized LOW Signal
V _{CD}	Input Clamp Diode Voltage			-1.2	V	Min	I _{IN} = -18 mA
V _{OH}	Output HIGH Voltage	54ABT			V	Min	I _{OH} = -3 mA
		54ABT			V	Min	I _{OH} = -24 mA
V _{OL}	Output LOW Voltage	54ABT		0.55	V	Min	I _{OL} = 48 mA
I _{IH}	Input HIGH Current			5	μA	Max	V _{IN} = 2.7V (Note 4)
				5	μA	Max	V _{IN} = V _{CC}
I _{BVI}	Input HIGH Current Breakdown Test			7	μA	Max	V _{IN} = 7.0V
I _{IL}	Input LOW Current			-5	μA	Max	V _{IN} = 0.5V (Note 4)
				-5	μA	Max	V _{IN} = 0.0V
V _{ID}	Input Leakage Test	4.75			V	0.0	I _{ID} = 1.9 μA All Other Pins Grounded
I _{OZH}	Output Leakage Current			50	μA	0 - 5.5V	V _{OUT} = 2.7V; $\overline{OE}_n = 2.0V$
I _{OZL}	Output Leakage Current			-50	μA	0 - 5.5V	V _{OUT} = 0.5V; $\overline{OE}_n = 2.0V$
I _{OS}	Output Short-Circuit Current	-100		-275	mA	Max	V _{OUT} = 0.0V
I _{CEx}	Output High Leakage Current			50	μA	Max	V _{OUT} = V _{CC}
I _{ZZ}	Bus Drainage Test			100	μA	0.0	V _{OUT} = 5.5V; All Others GND
I _{CCH}	Power Supply Current			50	μA	Max	All Outputs HIGH
I _{CCL}	Power Supply Current			30	mA	Max	All Outputs LOW
I _{CCZ}	Power Supply Current			50	μA	Max	$\overline{OE}_n = V_{CC}$; All Others at V _{CC} or Ground
				1.5	mA	Max	V _I = V _{CC} - 2.1V
				50	μA	Max	Enable Input V _I = V _{CC} - 2.1V Data Input V _I = V _{CC} - 2.1V All Others at V _{CC} or Ground
I _{CCD}	Dynamic I _{CC} (Note 4)	No Load		0.1	mA/ MHz	Max	Outputs Open $\overline{OE}_n = GND$, (Note 3) One Bit Toggling, 50% Duty Cycle

Note 3: For 8 bits toggling, I_{CCD} < 0.8 mA/MHz.

Note 4: Guaranteed, but not tested.

AC Electrical Characteristics

Symbol	Parameter	54ABT		Units	Fig. No.
		$T_A = -55^{\circ}\text{C to } +125^{\circ}\text{C}$			
		$V_{CC} = 4.5\text{V}-5.5\text{V}$ $C_L = 50\text{ pF}$			
		Min	Max		
t_{PLH}	Propagation Delay	0.8	5.5	ns	Figure 5
t_{PHL}	Data to Outputs	1.0	5.5		
t_{PZH}	Output Enable	0.8	7.5	ns	Figure 4
t_{PZL}	Time	0.8	7.7		
t_{PHZ}	Output Disable	1.0	7.5	ns	Figure 4
t_{PLZ}	Time	1.0	7.2		

Capacitance

Symbol	Parameter	Typ	Units	Conditions $T_A = 25^{\circ}\text{C}$
C_{IN}	Input Capacitance	5.0	pF	$V_{CC} = 0\text{V}$
C_{OUT} (Note 5)	Output Capacitance	9.0	pF	$V_{CC} = 5.0\text{V}$

Note 5: C_{OUT} is measured at frequency $f = 1\text{ MHz}$, per MIL-STD-883B, Method 3012.

AC Loading

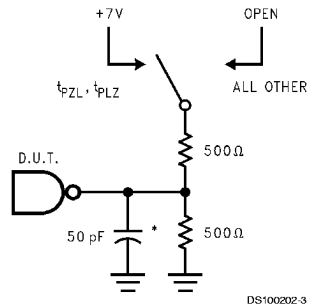

*Includes jig and probe capacitance

FIGURE 1. Standard AC Test Load

Amplitude	Rep. Rate	t_w	t_r	t_f
3.0V	1 MHz	500 ns	2.5 ns	2.5 ns

FIGURE 3. Test Input Signal Requirements

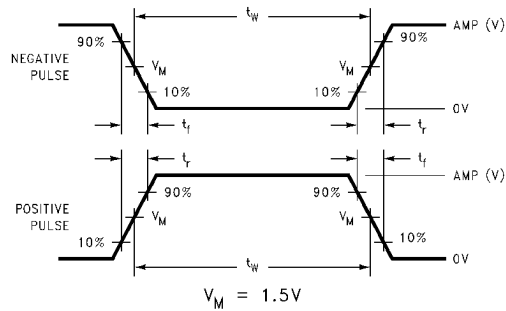

FIGURE 2. Test Input Signal Levels

AC Waveforms

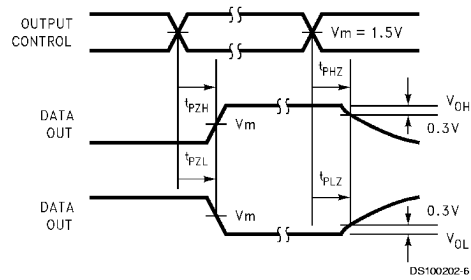

FIGURE 4. TRI-STATE Output HIGH and LOW Enable and Disable Times

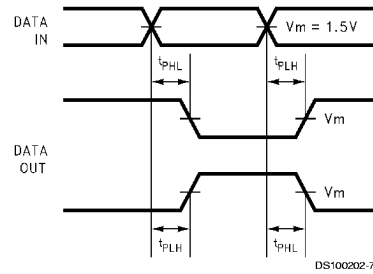
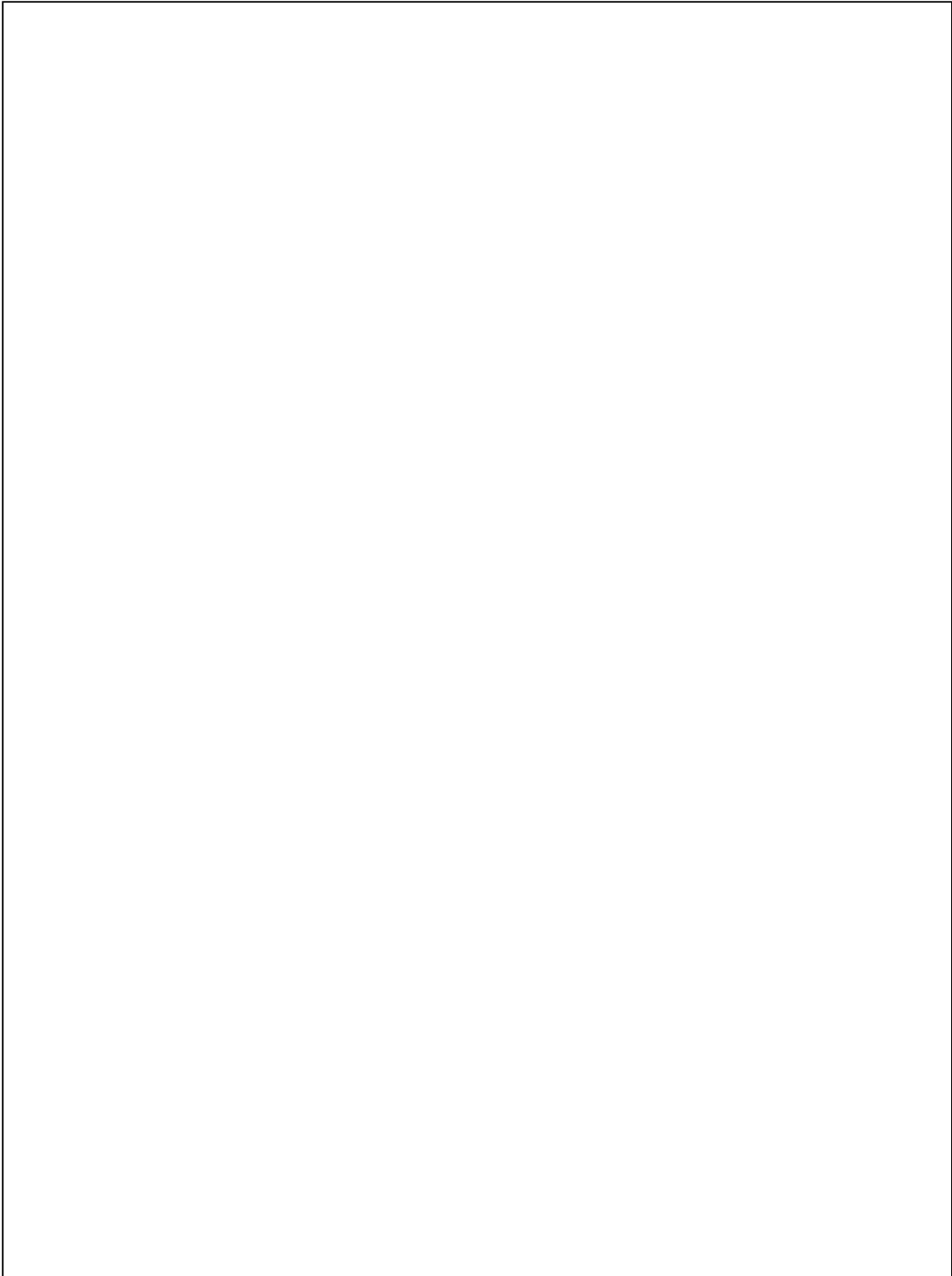
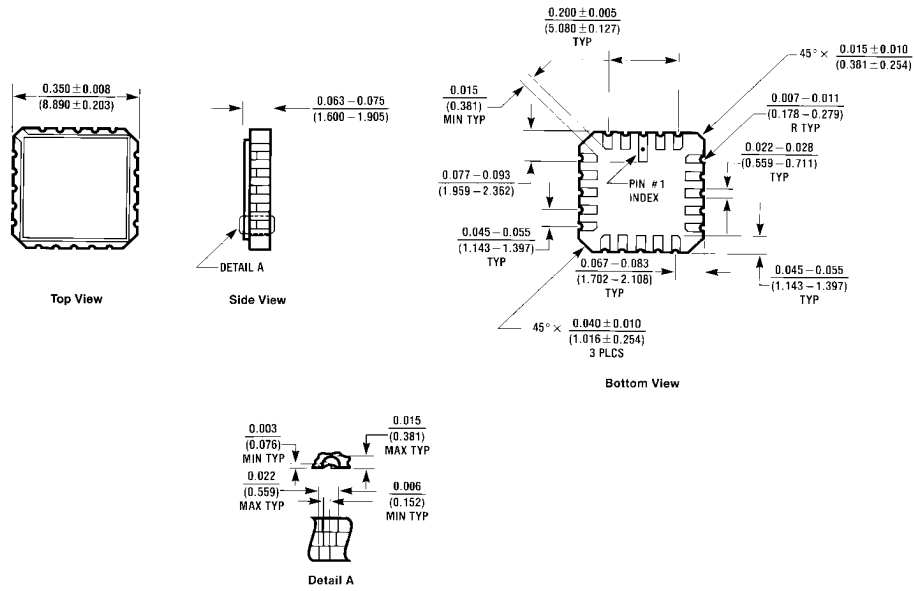

FIGURE 5. Propagation Delay Waveforms for Inverting and Non-Inverting Functions



Physical Dimensions inches (millimeters) unless otherwise noted



20-Terminal Ceramic Chip Carrier (L)
 NS Package Number E20A

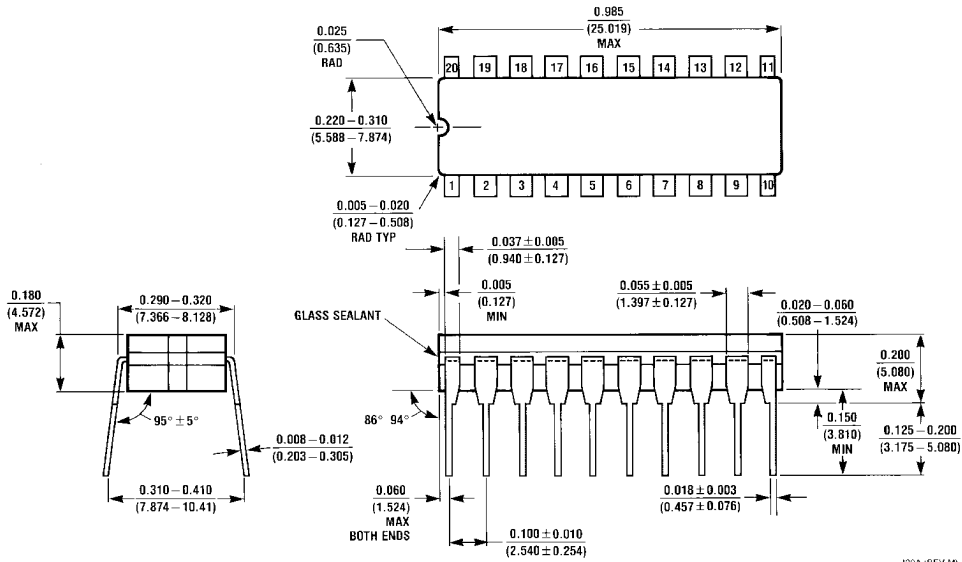

20-Lead Ceramic Dual-In-Line Package (D)
 NS Package Number J20A

Physical Dimensions inches (millimeters) unless otherwise noted (Continued)

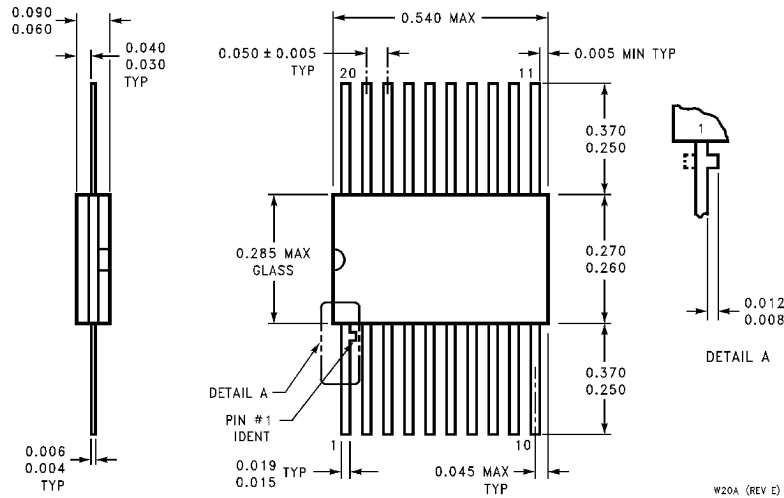

**20-Lead Ceramic Flatpak (F)
NS Package Number W20A**

LIFE SUPPORT POLICY

NATIONAL'S PRODUCTS ARE NOT AUTHORIZED FOR USE AS CRITICAL COMPONENTS IN LIFE SUPPORT DEVICES OR SYSTEMS WITHOUT THE EXPRESS WRITTEN APPROVAL OF THE PRESIDENT OF NATIONAL SEMICONDUCTOR CORPORATION. As used herein:

1. Life support devices or systems are devices or systems which, (a) are intended for surgical implant into the body, or (b) support or sustain life, and whose failure to perform when properly used in accordance with instructions for use provided in the labeling, can be reasonably expected to result in a significant injury to the user.
2. A critical component in any component of a life support device or system whose failure to perform can be reasonably expected to cause the failure of the life support device or system, or to affect its safety or effectiveness.



National Semiconductor Corporation
Americas
Tel: 1-800-272-9959
Fax: 1-800-737-7018
Email: support@nsc.com

National Semiconductor Europe
Fax: +49 (0) 1 80-530 85 86
Email: europe.support@nsc.com
Deutsch Tel: +49 (0) 1 80-530 85 85
English Tel: +49 (0) 1 80-532 78 32
Français Tel: +49 (0) 1 80-532 93 58
Italiano Tel: +49 (0) 1 80-534 16 80

National Semiconductor Asia Pacific Customer Response Group
Tel: 65-2544466
Fax: 65-2504466
Email: sea.support@nsc.com

National Semiconductor Japan Ltd.
Tel: 81-3-5620-6175
Fax: 81-3-5620-6179

www.national.com

National does not assume any responsibility for use of any circuitry described, no circuit patent licenses are implied and National reserves the right at any time without notice to change said circuitry and specifications.