

**TIANMA Microelectronics (U.S.A.) Inc.**

**SPECIFICATION FOR LCD MODULE**

Model No. TM240128ACCWU

**To:**

Customer's Approval

Date: \_\_\_\_\_

By: \_\_\_\_\_

Presented

By: \_\_\_\_\_

Tianma Microelectronics (U.S.A.) Inc.

## 1. Display Specifications

- 1.1 Display type: FSTN
- 1.2 Display color: Black on White
- 1.3 Polarize mode: Positive, Transflective
- 1.4 Viewing Angle: 12:00
- 1.5 Driving Duty: 1/128
- 1.6 Backlight: Yellow-green LED

## 2. Mechanical Specifications

- 2.1 Outline Dimensions: Refer to outline drawing on page 2
- 2.2 Dot Matrix: 240 x 128
- 2.3 Dot size: 0.4 x 0.4 mm
- 2.4 Dot pitch: 0.45 x 0.45 mm

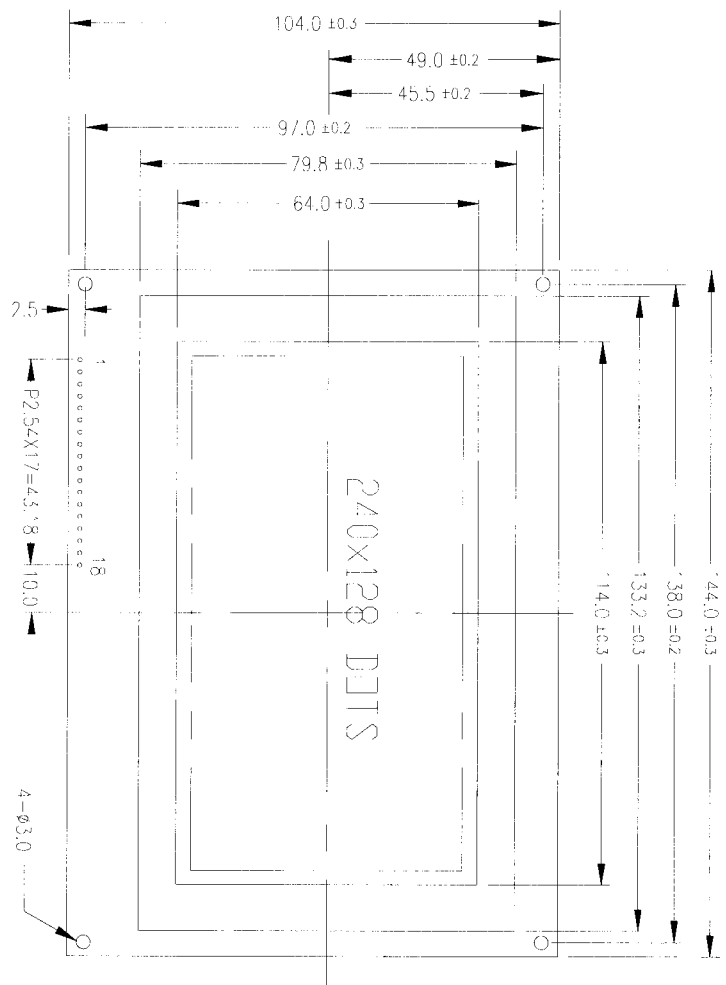

1	2	3	4	5	6	7	8	9	10	11	12	13	14	15	16	17	18
1G	2G	3G	4G	5G	6G	7G	8G	9G	10G	11G	12G	13G	14G	15G	16G	17G	18G
1G	2G	3G	4G	5G	6G	7G	8G	9G	10G	11G	12G	13G	14G	15G	16G	17G	18G

TYPE	*1	*2
R&EL	5.3	12.0
LED	8.0	15.0

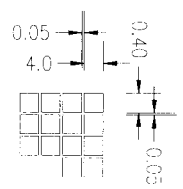
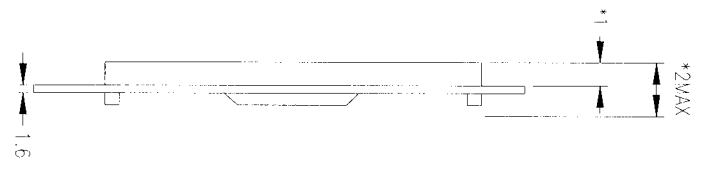

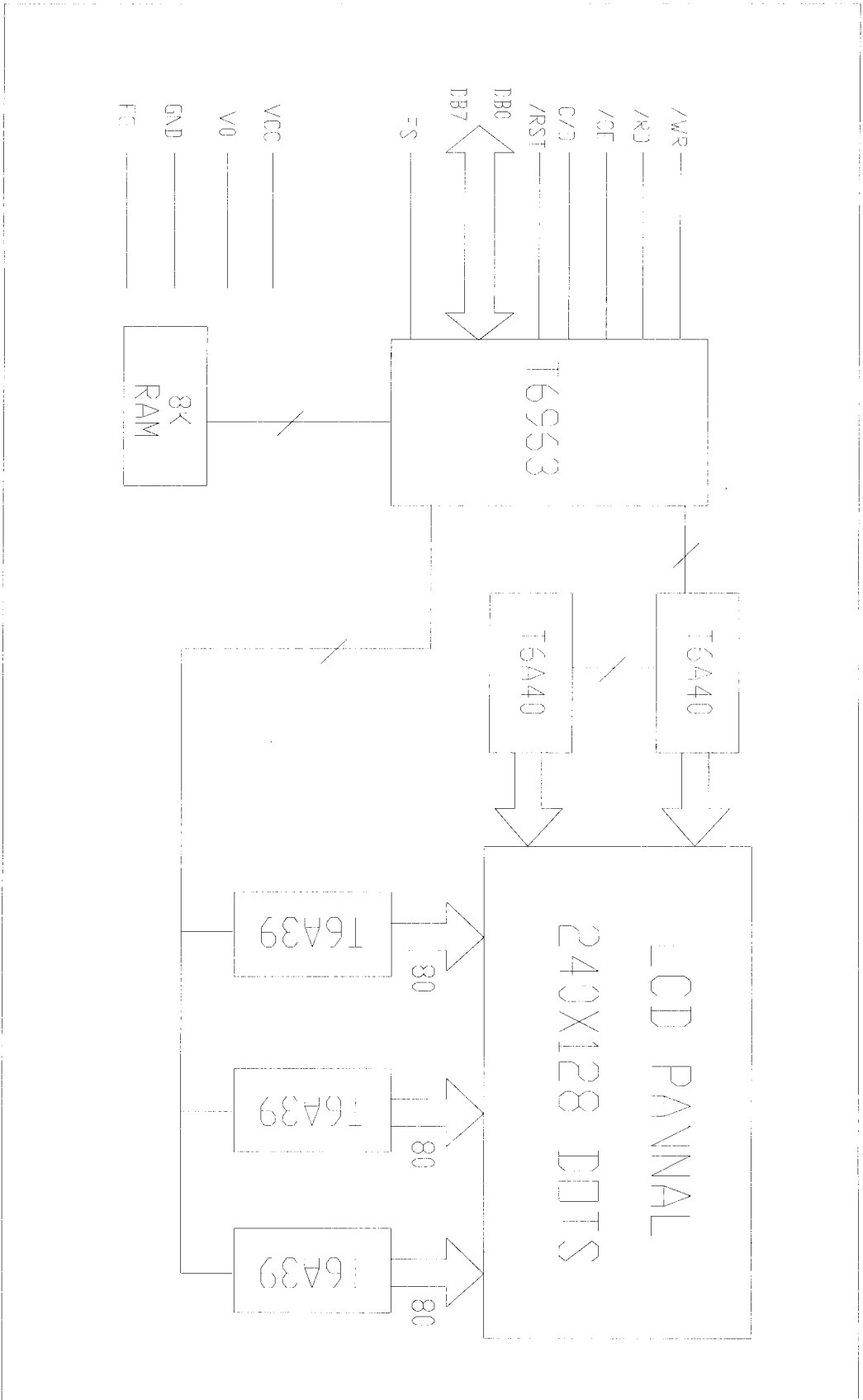

#### 4 Absolute Maximum Ratings

Item	Symbol	Min.	Max.	Unit	Remark
Power Supply Voltage	V <sub>DD-VSS</sub>	0	7.0	V	
LCD Driving Voltage	V <sub>DD-V<sub>EE</sub></sub>	-	18.0		
Operating Temperature Range	T <sub>OP</sub>	0	50	°C	No Condensation
Storage Temperature Range	T <sub>ST</sub>	-20	60		

#### 5 Electrical Specifications and Instruction Code

##### 5.1 Electrical characteristics

Item	Symbol	Min.	Typ.	Max.	Unit	Remark	
Supply Voltage (logic)	V <sub>DD-VSS</sub>	4.5	5.0	5.5	V		
Supply Voltage (LCD Drive)	V <sub>SS-V<sub>EE</sub></sub>	-	11.0	-	V		
Input Signal Voltage	'H' Level	V <sub>IH</sub>	V <sub>DD-2.2</sub>	-	V <sub>DD</sub>	V	
	'L' level	V <sub>IL</sub>	0	-	0.8	V	
Supply current (logic)	I <sub>DD</sub>	-	4.0	-	mA		
Supply current (LCD Drive)	I <sub>EE</sub>	-	4.0	-	mA		

## 5.2 Interface Signals

Pin No.	Symbol	Description(Function)	Remark
1	FG	Module Frame Ground	
2	Vss	Ground	
3	VDD	Supply voltage for logic and LCD(+)	
4	V <sub>o</sub>	Operating voltage for LCD	variable
5	$\overline{WR}$	Data Write into T6963C	
6	$\overline{RD}$	Data Read from T6963C	
7	$\overline{CE}$	Chip enable Signal	
8	C/ $\overline{D}$	Command/Data Selection	
9	$\overline{Reset}$	Reset signal	
10	DB0	Data bit 0	
11	DB1	Data bit 1	
12	DB2	Data bit 2	
13	DB3	Data bit 3	
14	DB4	Data bit 4	
15	DB5	Data bit 5	
16	DB6	Data bit 6	
17	DB7	Data bit 7	
18	FS	Font Selection	

- Switching Characteristics (2)

Bus Timing

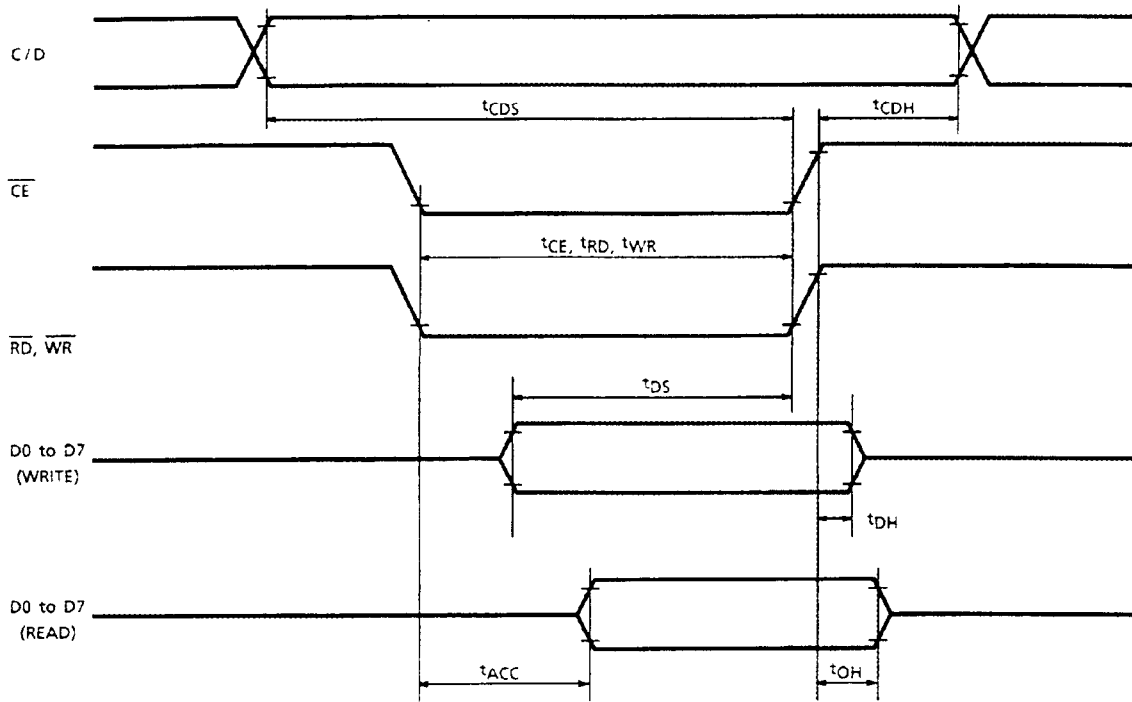

TEST CONDITIONS (Unless otherwise noted,  $V_{DD} = 5.0V \pm 10\%$ ,  $V_{SS} = 0V$ ,  $T_a = -20$  to  $75^\circ C$ )

ITEM	SYMBOL	TEST CONDITIONS	MIN	MAX	UNIT
C/D Set-up Time	$t_{CDS}$	—	100	—	ns
C/D Hold Time	$t_{CDH}$	—	10	—	ns
$\overline{CE}$ , $\overline{RD}$ , $\overline{WR}$ Pulse Width	$t_{CE}, t_{RD}, t_{WR}$	—	80	—	ns
Data Set-up Time	$t_{DS}$	—	80	—	ns
Data Hold Time	$t_{DH}$	—	40	—	ns
Access Time	$t_{ACC}$	—	—	150	ns
Output Hold Time	$t_{OH}$	—	10	50	ns

## 5.4 Instruction Code

COMMAND LIST

COMMAND	CODE	D1	D2	FUNCTION
REGISTER SET	00100001	X address	Y address	Cursor pointer set
	00100010	Data	00H	Offset register set
	00100100	Low address	High address	Address pointer set
CONTROL WORD SET	01000000	Low address	High address	Text home address set
	01000001	Columns	00H	Text area set
	01000010	Low address	High address	Graphic home address set
	01000011	Columns	00H	Graphic area set
MODE SET	1000X000	-	-	"OR" mode
	1000X001	-	-	"EXOR" mode
	1000X011	-	-	"AND" mode
	1000X100	-	-	"Text attribute" mode
	1000XXXX	-	-	Internal CG ROM mode
	1000XXXX	-	-	External CG RAM mode
DISPLAY MODE	10010000	-	-	Display off
	1001XX10	-	-	Cursor on, blink off
	1001XX11	-	-	Cursor on, blink on
	100101XX	-	-	Text on, graphic off
	100110XX	-	-	Text off, graphic on
	100111XX	-	-	Text on, graphic on
CURSOR PATTERN SELECT	10100000	-	-	1 line cursor
	10100001	-	-	2 lines cursor
	10100010	-	-	3 lines cursor
	10100011	-	-	4 lines cursor
	10100100	-	-	5 lines cursor
	10100101	-	-	6 lines cursor
	10100110	-	-	7 lines cursor
	10100111	-	-	8 lines cursor
DATA AUTO READ/WRITE	10110000	-	-	Data auto write set
	10110001	-	-	Data auto read set
	10110010	-	-	Auto reset
DATA READ WRITE	11000000	Data	-	Data write and ADP increment
	11000001	-	-	Data read and ADP increment
	11000010	Data	-	Data write and ADP decrement
	11000011	-	-	Data read and ADP decrement
	11000100	Data	-	Data write and ADP nonvariable
	11000101	-	-	Data read and ADP nonvariable
SCREEN PEEK	11100000	-	-	Screen peek
SCREEN COPY	11101000	-	-	Screen copy
BIT SET/RESET	1111XXXX	-	-	bit reset
	11111XXX	-	-	bit set
	1111X000	-	-	bit0(LSB)
	1111X001	-	-	bit1
	1111X010	-	-	bit2
	1111X011	-	-	bit3
	1111X100	-	-	bit4
	1111X101	-	-	bit5
	1111X110	-	-	bit6
	1111X111	-	-	bit7(MSB)



CHARACTER CODE MAP  
ROM code 0101

MSB \ LSB	0	1	2	3	4	5	6	7	8	9	A	B	C	D	E	F
0	.	!	"	#	\$	%	&	'	(	)	*	+	,	-	.	/
1	0	1	2	3	4	5	6	7	8	9	:	;	<	=	>	?
2	@	A	B	C	D	E	F	G	H	I	J	K	L	M	N	O
3	P	Q	R	S	T	U	V	W	X	Y	Z	[	\	]	^	_
4	^	a	b	c	d	e	f	g	h	i	j	k	l	m	n	o
5	p	q	r	s	t	u	v	w	x	y	z	{		}	~	
6	5	6	7	8	9	0	1	2	3	4	5	6	7	8	9	0
7	1	2	3	4	5	6	7	8	9	0	1	2	3	4	5	6

6. Optical Characteristics

6.1 Optical Characteristics

Ta=25°C

Item	Symbol	Condition	Min.	Typ.	Max.	Unit	Remark
Viewing Angle	$\theta_x$	Cr) 3	$\theta_y=0^\circ$	-20	—	20	Deg
	$\theta_y$		$\theta_x=0^\circ$	-25	—	25	
Contrast Ratio	Cr	$\theta_x=0^\circ$ $\theta_y=15^\circ$	3				
Response Time	Turn on	$\theta_x=0^\circ$ $\theta_y=0^\circ$			200	ms	
	Turn off				360		

## 6.2 Definition of optical characteristics

### 6.2.1 Definition of viewing Angle (see fig. as follow)

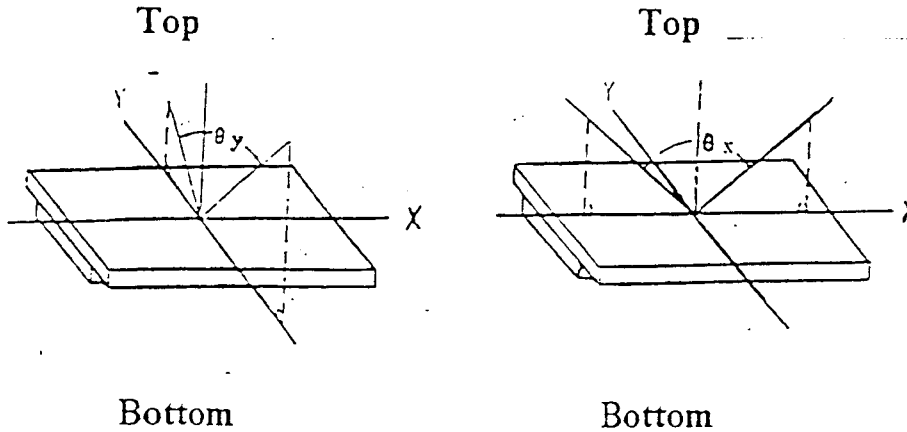

### 6.2.2 Definition of Contrast Ratio (see fig. as follow)

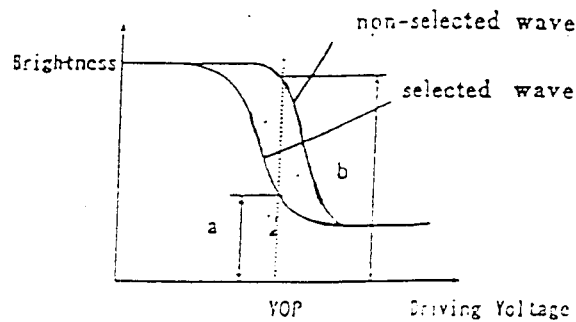

non-selected state brightness

$$\text{Contrast Ratio} = \frac{b}{a} = \frac{\text{selected state brightness}}{\text{non-selected state brightness}}$$

Measuring Conditions:

- 1) Ambient Temperature: 25 °C ;
- 2) Frame frequency: 32Hz

### 6.2.3 Definition of Response time (see fig. as follow)

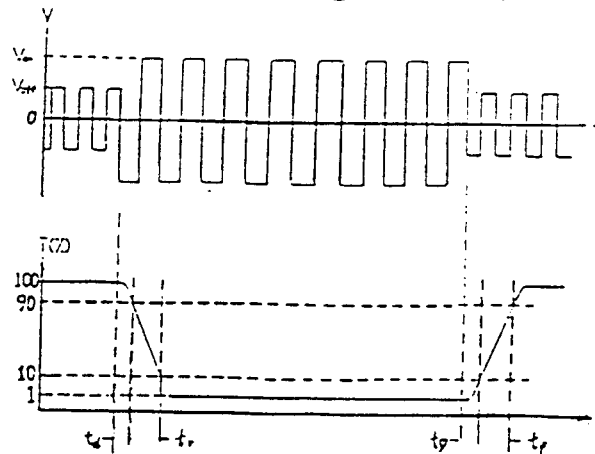

Turn-on time:  $t_{on} = t_d + t_r$

Turn-off time:  $t_{off} = t_d + t_f$

Measuring Condition:

- 1) Operating Voltage: 12 V ;
- 2) Frame frequency: 32Hz

## 7. Reliability

### 7.1 Content of Reliability Test

No.	Test Item	Content of Test	Test condition
1	High Temperature Storage	Endurance test applying the high storage temperature for a long time	60 °C 96H
2	Low Temperature Storage	Endurance test applying the low storage temperature for a long time	-20 °C 96H
3	High Temperature Operation	Endurance test applying the Temperature electric stress (voltage & current) and the thermal stress to the element for a long time	50 °C 96H
4	Low Temperature Operation	Endurance test applying the electric stress under low temperature for a long time	0 °C 96H
5	High Temperature /Humidity Storage	Endurance test applying the high temperature and high humidity storage for a long time	40 °C 90%RH 96H
6	Temperature Cycle	Endurance test applying the low and high temperature cycle 10 cycle $  \begin{array}{ccccccc}  -20\text{ }^{\circ}\text{C} & \longleftrightarrow & 25\text{ }^{\circ}\text{C} & \longleftrightarrow & 60\text{ }^{\circ}\text{C} & \longleftrightarrow & 25\text{ }^{\circ}\text{C} \\  30\text{min} & & 5\text{min} & & 30\text{min} & & 5\text{min} \\  \longleftarrow & & & & & & \longrightarrow \\  & & & & & & \text{1 cycle}  \end{array}  $	-20 °C/60 °C
7	Vibration Test (package state)	Endurance test applying the vibration during transportation	10Hz~55Hz ~10Hz; 1.5mmP-P,1.5g; X.Y.-5min
8	Shock Test (package state)	Endurance test applying the shock during transportation	Drop a product from a height of 76cm to a solid unbending and horizontal plane
9	Atmospheric Pressure Test	Endurance test applying the atmospheric pressure during transportation by air	40kPa 24H

## 7.2 Failure Judgment Criterion

Criterion Item	Test Item No.									Failure Judgement Criterion	
	1	2	3	4	5	6	7	8	9		
Basic Specification	0	0	0	0	0	0	0	0	0	0	Out of the basic specification
Electrical Specification	0	0	0	0	0						Out of the electrical specification
Mechanical Specification						0	0	0			Out of the mechanical specification
Optical Characteristic	0	0	0	0	0	0				0	Out of the optical specification
Remark	Basic specification= Display specification + Mechanical specification										

## 8 Precautions for use of LCD Modules.

### 8.1 Handling Precautions

- 8.1.1 The display panel is made of glass. Do not subject it to a mechanical shock by dropping it from a high place, etc.
- 8.1.2 If the display panel is damaged and the liquid crystal substance inside it leaks out, be sure not to get any in your mouth, if the substance comes into contact with your skin or clothes, promptly wash it off using soap and water.
- 8.1.3 Do not apply excessive force to the display surface or the adjoining areas since this may cause the color tone to vary.
- 8.1.4 The polarizer covering the display surface of the LCD module is soft and easily scratched. Handle this polarizer carefully.
- 8.1.5 If the display surface is contaminated, breathe on the surface and gently wipe it with a soft dry cloth. If still not completely clear, moisten cloth with one of the following solvents:
- Isopropyl alcohol
  - Ethyl alcohol
- Solvents other than those mentioned above may damage polarizer. Especially, do not use the following:
- Water
  - Ketone
  - Aromatic solvents
- 8.1.6 Do not attempt to disassemble the LCD Module.
- 8.1.7 NC terminal should be open. Do not connect anything.
- 8.1.8 If the logic circuit power is off, do not apply the input signals.
- 8.1.9 To prevent destruction of the elements by static electricity, be careful to maintain an optimum work environment.
- a. Be sure to ground the body when handling the LCD Modules.
  - b. Tools required for assembly, such as soldering irons, must be properly ground.
  - c. To reduce the amount of static electricity generated do not conduct assembly and other work under dry conditions.
  - d. The LCD Module is coated with a film to protect the display surface. Be care when peeling off this protective film since static electricity may be generated.