

PLEASE CHECK WWW.MOLEX.COM FOR LATEST PART INFORMATION

Part Number: **0749598008**
Status: **Active**
Overview: vhdm_hsd
Description: 2.00mm (.079") Pitch 8-Row VHDM-HSD™ Backplane Header, Polarizing Pin Module, Code Key H, 40 Circuits

Documents:

[Drawing \(PDF\)](#) [RoHS Certificate of Compliance \(PDF\)](#)

General

Product Family	Backplane Connectors
Series	74959
Application	Backplane
Application Tooling Documents	Tooling Manual
Comments	Position H, PCB Thickness 1.80mm (.070") to 4.00mm (.157")
Component Type	PCB Header
Overview	vhdm_hsd
Product Name	VHDM-HSD™
Style	N/A

Physical

Circuits (Loaded)	N/A
Circuits (maximum)	0
Durability (mating cycles max)	200
First Mate / Last Break	No
Guide to Mating Part	Yes
Keying to Mating Part	Yes
Material - Metal	Stainless Steel
Number of Columns	8
Number of Pairs	Open Pin Field
Number of Rows	0
Orientation	Vertical
PC Tail Length (in)	0.000 In
PC Tail Length (mm)	0.00 mm
PCB Retention	None
PCB Thickness Recommended (in)	0.000 In
PCB Thickness Recommended (mm)	0.00 mm
Packaging Type	Bag
Pitch - Mating Interface (in)	0.000 In
Pitch - Mating Interface (mm)	0.00 mm
Pitch - Term. Interface (in)	0.000 In
Pitch - Term. Interface (mm)	0.00 mm
Polarized to PCB	N/A
Surface Mount Compatible (SMC)	Yes
Temperature Range - Operating	N/A

Electrical

Current - Maximum per Contact	N/A
Data Rate	5.0 Gbps
Voltage - Maximum	N/A

Material Info

Reference - Drawing Numbers

Sales Drawing	SD-74959-002
---------------	--------------

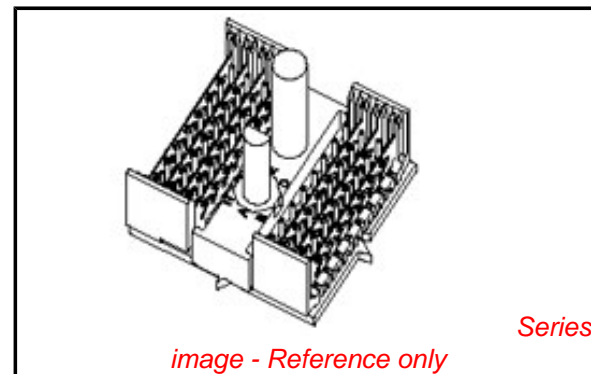

EU RoHS	China RoHS
Compliance Status	
Not Reviewed	
REACH SVHC	
Not Reviewed	
Halogen-Free	
Status	
Not Reviewed	

Need more information on product environmental compliance?

Email productcompliance@molex.com
 For a multiple part number RoHS Certificate of Compliance, [click here](#)

Please visit the [Contact Us](#) section for any non-product compliance questions.

Search Parts in this Series









[74959Series](#)

| VHDM-HSD is a trademark of Amphenol Corporation

This document was generated on 05/28/2010

PLEASE CHECK WWW.MOLEX.COM FOR LATEST PART INFORMATION

20 19 18 17 16 15 14 13 12 11 10 9 8 7 6 5 4 3 2 1

MATERIAL NUMBER PCB THICKNESS > 4.0 - 9.0	MATERIAL NUMBER PCB THICKNESS 18 - 4.0	BUSHING CLOCK POSITION
74959-8901	74959-8001	A 
74959-8902	74959-8002	B 
74959-8903	74959-8003	C 
74959-8904	74959-8004	D 
74959-8905	74959-8005	E 
74959-8906	74959-8006	F 
74959-8907	74959-8007	G 
74959-8908	74959-8008	H 

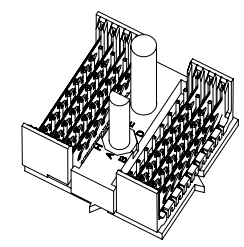
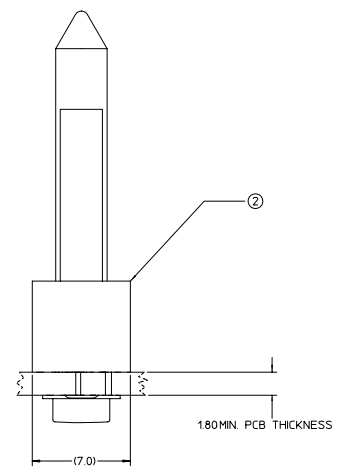
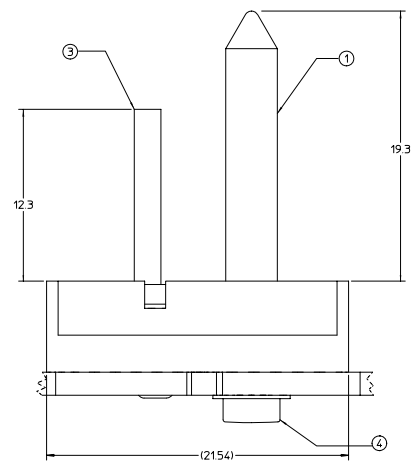
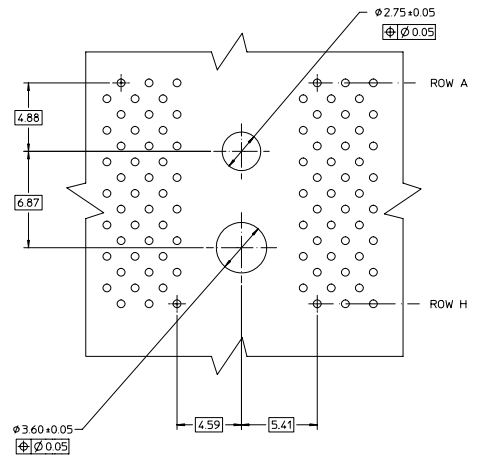
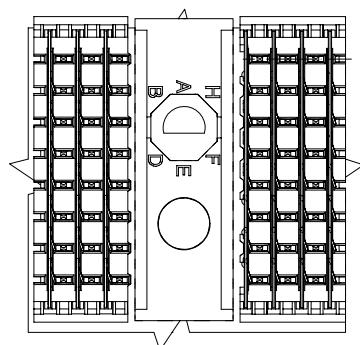

BILL OF MATERIAL 74959-8***

ITEM	DESCRIPTION	QTY.
1	GUIDE PIN	1
2	GUIDANCE & POLARIZING MODULE	1
3	KEYING PIN	1
4	SCREW & WASHER (PCB 18-4.0)	1

BILL OF MATERIAL 74959-89**

ITEM	DESCRIPTION	QTY.
1	GUIDE PIN	1
2	GUIDANCE & POLARIZING MODULE	1
3	KEYING PIN	1
4	SCREW & WASHER (PCB >4.0-9.0)	1

NOTES:

- 1 MATERIAL: LIQUID CRYSTAL POLYMER (LCP).
COLOR : BLACK
- 2 THIS PART CONFORMS TO MOLEX SPECIFICATION
PS-74031-999
- 3 PACKAGING : STANDARD BULK PACK, 100 PER BAG
PACKAGE SCREW SEPARATELY.

EC NO. LDT2002-0414 DRWN: LMSLEY 2002/03/05 CHKD: MOWANG 2002/03/05 APPR: CBIXLER 2002/03/06 REV DESCRIPTION	GENERAL TOLERANCES (UNLESS SPECIFIED)		SCALE 6:1	DESIGN UNITS METRIC	THIRD ANGLE PROJECTION	REVISE ON CAD ONLY	
	4 PLACES ± --- ± --- 3 PLACES ± --- ± --- 2 PLACES ± --- ± --- 1 PLACE ± --- ± ---	mm INCH	DIMENSION STYLE MM ONLY		TITLE BACKPLANE GUIDANCE AND POLARIZING MODULE 8 ROW SALES DRAWING		
	ANGULAR ± 2 °		DRAWN BY NMARTIN	DATE 01/12/10	MOLEX MOLEX INCORPORATED		
	DRAFT WHERE APPLICABLE MUST REMAIN WITHIN DIMENSIONS		CHECKED BY JLAURX	DATE 01/12/10	MATERIAL NO. SEE CHART	DOCUMENT NO. SD-74959-002	SHEET NO 1 OF 1

THIS DRAWING CONTAINS INFORMATION THAT IS PROPRIETARY TO MOLEX INCORPORATED AND SHOULD NOT BE USED WITHOUT WRITTEN PERMISSION

1b_frame_D rev B 2000/06/12 19 18 17 16 15 14 13 12 11 10 9 8 7 6 5 4 3 2 1