

BCR5PM-14

MEDIUM POWER USE
INSULATED TYPE, PLANAR PASSIVATION TYPE

BCR5PM-14



- IT (RMS) 5A
- VDRM 700V
- IFGT I, IRGT I, IRGT III 30mA
- V_{iso} 2000V
- UL Recognized: Yellow Card No.E80276(N)
File No. E80271

OUTLINE DRAWING

Dimensions
in mm

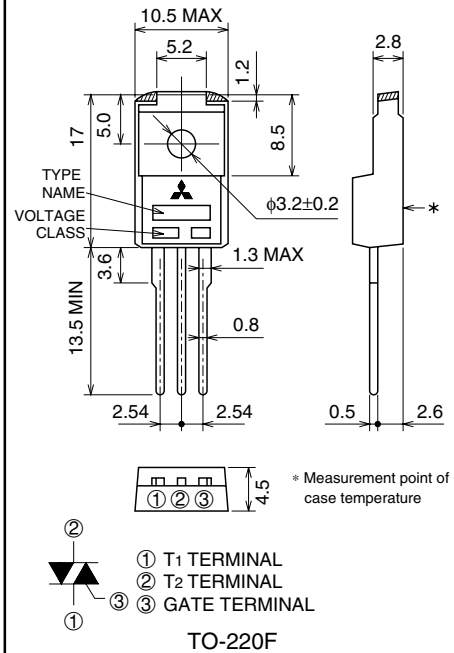

APPLICATION

Switching mode power supply, washing machine, small motor control, copying machine, other general purpose control applications

MAXIMUM RATINGS

Symbol	Parameter	Voltage class	
		14	Unit
VDRM	Repetitive peak off-state voltage *1	700	V
VD _{SM}	Non-repetitive peak off-state voltage *1	840	V

Symbol	Parameter	Conditions	Ratings	Unit
I _T (RMS)	RMS on-state current	Commercial frequency, sine full wave 360° conduction, T _c =95°C	5	A
I _{TSM}	Surge on-state current	60Hz sinewave 1 full cycle, peak value, non-repetitive	50	A
I _t ²	I _t ² for fusing	Value corresponding to 1 cycle of half wave 60Hz, surge on-state current	10.4	A ² s
P _{GM}	Peak gate power dissipation		3	W
P _{G(AV)}	Average gate power dissipation		0.3	W
V _{GM}	Peak gate voltage		10	V
I _{GM}	Peak gate current		2	A
T _j	Junction temperature		-40 ~ +125	°C
T _{stg}	Storage temperature		-40 ~ +125	°C
—	Weight	Typical value	2.0	g
V _{iso}	Isolation voltage	T _a =25°C, AC 1 minute, T1 · T2 · G terminal to case	2000	V

*1. Gate open.

BCR5PM-14

MEDIUM POWER USE
INSULATED TYPE, PLANAR PASSIVATION TYPE

ELECTRICAL CHARACTERISTICS

Symbol	Parameter	Test conditions	Limits			Unit	
			Min.	Typ.	Max.		
I _{DRM}	Repetitive peak off-state current	T _j =125°C, V _{DRM} applied	—	—	2.0	mA	
V _{TM}	On-state voltage	T _c =25°C, I _{TM} =7A, Instantaneous measurement	—	—	1.8	V	
V _{FGT I}	Gate trigger voltage *2	T _j =25°C, V _D =6V, R _L =6Ω, R _G =330Ω	I	—	—	1.5	V
V _{RGT I}			II	—	—	1.5	V
V _{RGT III}			III	—	—	1.5	V
I _{FGT I}	Gate trigger current *2	T _j =25°C, V _D =6V, R _L =6Ω, R _G =330Ω	I	—	—	30	mA
I _{RGT I}			II	—	—	30	mA
I _{RGT III}			III	—	—	30	mA
V _{GD}	Gate non-trigger voltage	T _j =125°C, V _D =1/2V _{DRM}	0.2	—	—	V	
R _{th (j-c)}	Thermal resistance	Junction to case *3	—	—	4.0	°C/W	
(dv/dt) _c	Critical-rate of rise of off-state commutating voltage *4	T _j =125°C	5	—	—	V/μs	

*2. Measurement using the gate trigger characteristics measurement circuit.

*3. The contact thermal resistance R_{th (c-f)} in case of greasing is 0.5°C/W.

*4. Test conditions of the critical-rate of rise of off-state commutating voltage is shown in the table below.

Test conditions	Commutating voltage and current waveforms (inductive load)
1. Junction temperature T _j =125°C 2. Rate of decay of on-state commutating current (di/dt) _c =-2.5A/ms 3. Peak off-state voltage V _D =400V	

PERFORMANCE CURVES

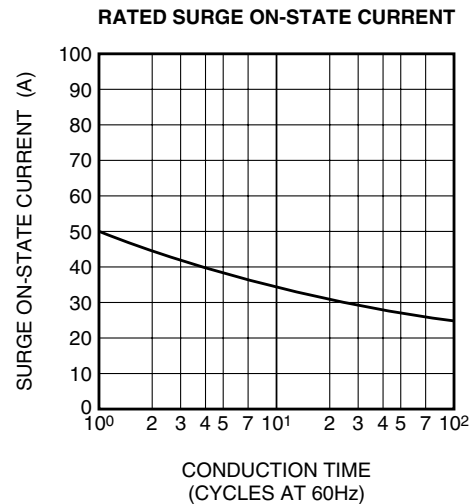
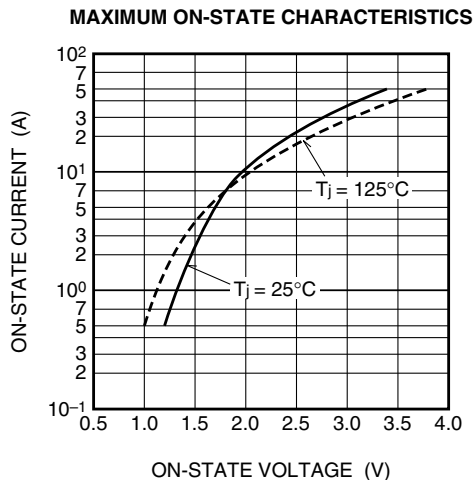

BCR5PM-14

MEDIUM POWER USE
INSULATED TYPE, PLANAR PASSIVATION TYPE

**GATE CHARACTERISTICS
(I, II AND III)**

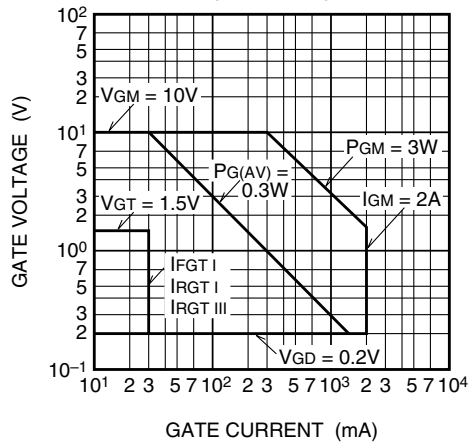

**GATE TRIGGER CURRENT VS.
JUNCTION TEMPERATURE**

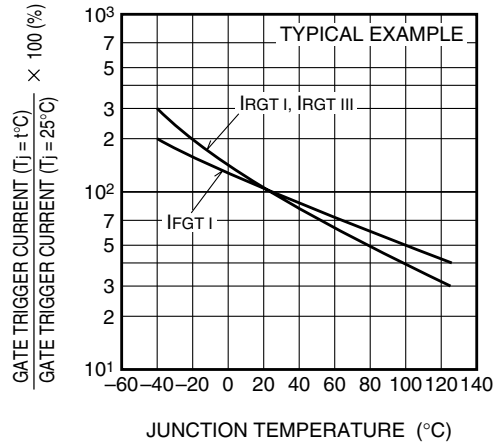

**GATE TRIGGER VOLTAGE VS.
JUNCTION TEMPERATURE**

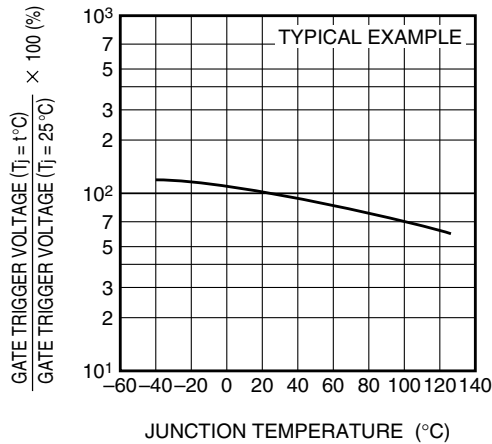

**MAXIMUM TRANSIENT THERMAL
IMPEDANCE CHARACTERISTICS
(JUNCTION TO CASE)**

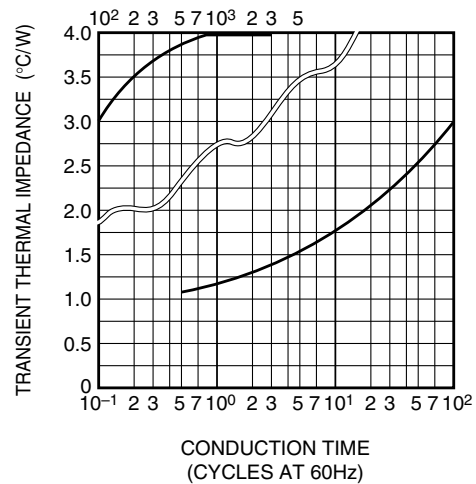

**MAXIMUM TRANSIENT THERMAL
IMPEDANCE CHARACTERISTICS
(JUNCTION TO AMBIENT)**

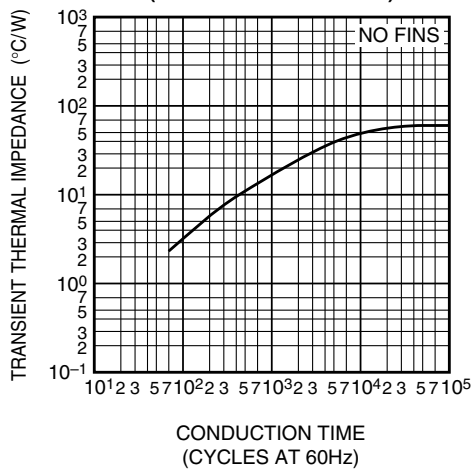

**MAXIMUM ON-STATE POWER
DISSIPATION**

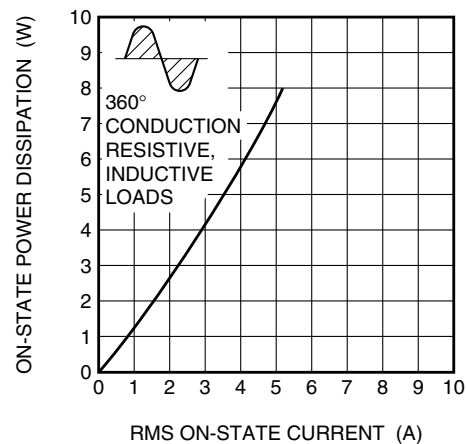

BCR5PM-14

MEDIUM POWER USE
INSULATED TYPE, PLANAR PASSIVATION TYPE

ALLOWABLE CASE TEMPERATURE VS. RMS ON-STATE CURRENT

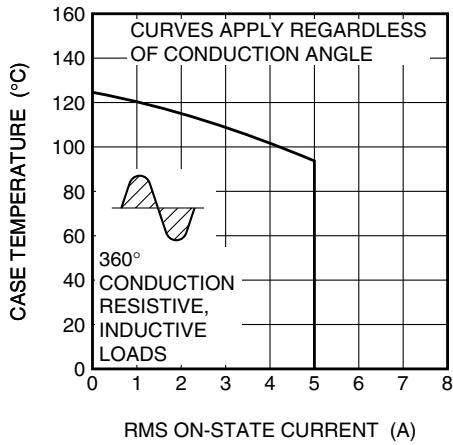

ALLOWABLE AMBIENT TEMPERATURE VS. RMS ON-STATE CURRENT

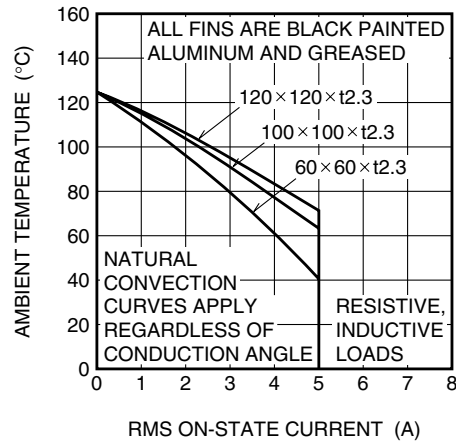

ALLOWABLE AMBIENT TEMPERATURE VS. RMS ON-STATE CURRENT

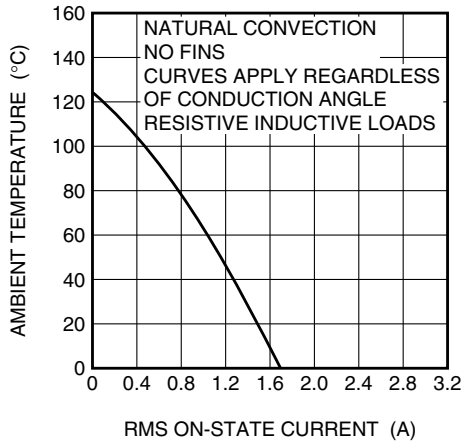

REPETITIVE PEAK OFF-STATE CURRENT VS. JUNCTION TEMPERATURE

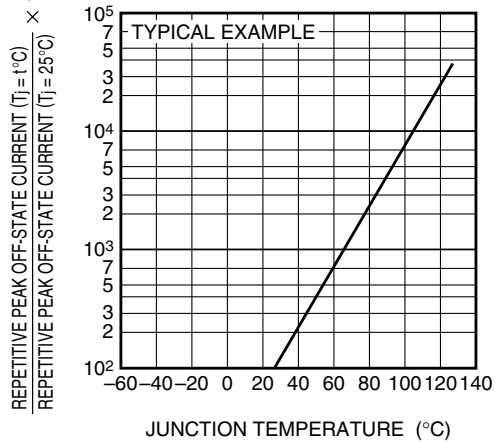

HOLDING CURRENT VS. JUNCTION TEMPERATURE

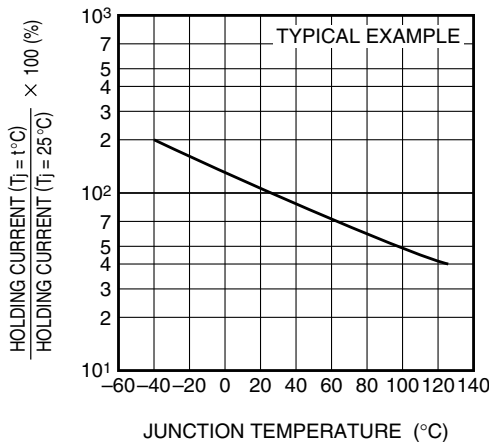

LACHING CURRENT VS. JUNCTION TEMPERATURE

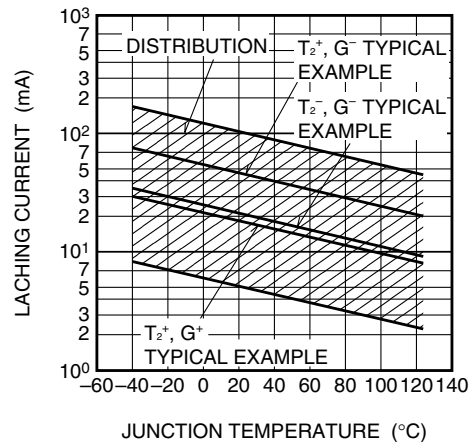

BCR5PM-14

MEDIUM POWER USE
INSULATED TYPE, PLANAR PASSIVATION TYPE

BREAKEOVER VOLTAGE VS. JUNCTION TEMPERATURE

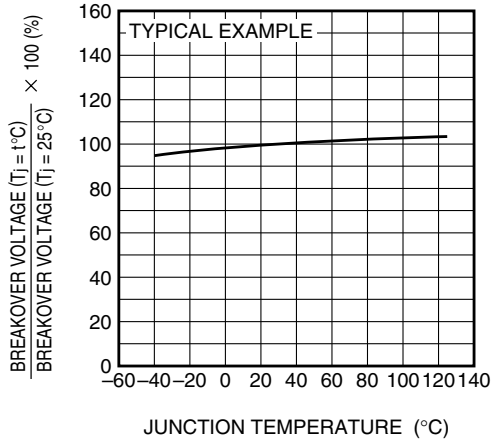

BREAKEOVER VOLTAGE VS. RATE OF RISE OF OFF-STATE VOLTAGE

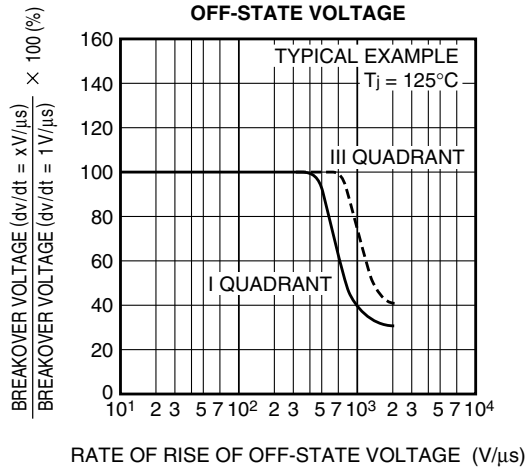

COMMUTATION CHARACTERISTICS

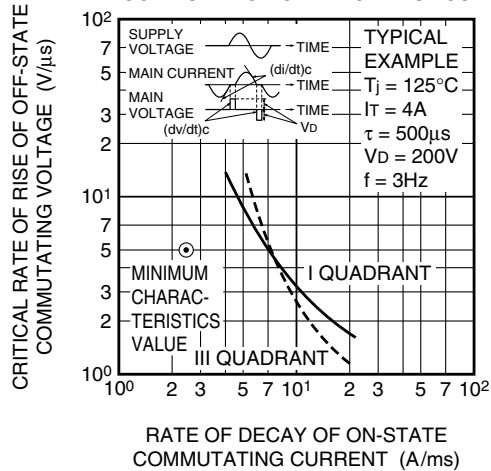

GATE TRIGGER CURRENT VS. GATE CURRENT PULSE WIDTH

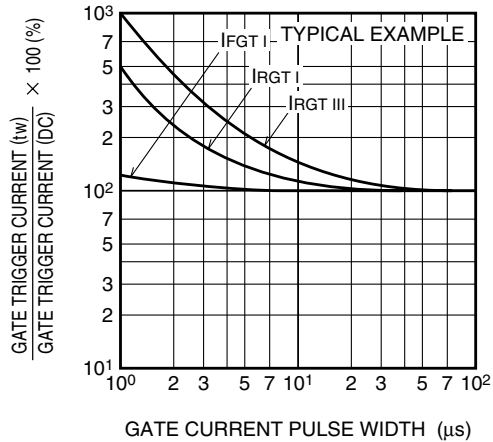

GATE TRIGGER CHARACTERISTICS TEST CIRCUITS

