

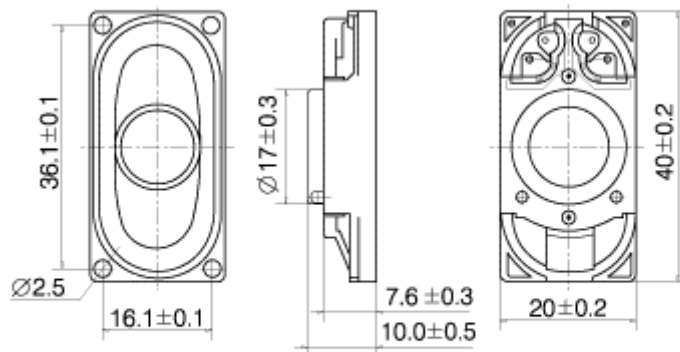

Type	BLS-2040
Rated Impedance( $\Omega$ )	$8 \pm 15\%$
Rated(Max.) Power(W)	1(2)
Resonant Frequency(Hz)	$450 \pm 20\%$
Rated Freq.Range(Hz)	$f_0 \sim 5000$
Sound Pressure Level(dB)	$78 \pm 3$
Magnet(g)	1.1
Operating Temperature( $^{\circ}\text{C}$ )	$-10 \sim +40$



Unit:mm

