

**FYLS - 3528GC**

**Features:**

- Single color
- Suitable for all SMT assembly and solder process.
- Available on tape and Reel
- Package :2000pcs/ Reel

**Description.**

- The green source color devices are made with Gallium Arsenide Phosphide on Gallium Phosphide green Light Emitting Diode.
- It is recommended to use a wrist band or anti-electrostatic glove when handling the LEDs.
- All devices.equipment and machinery must be electrically grounded.

**Package Dimensions**

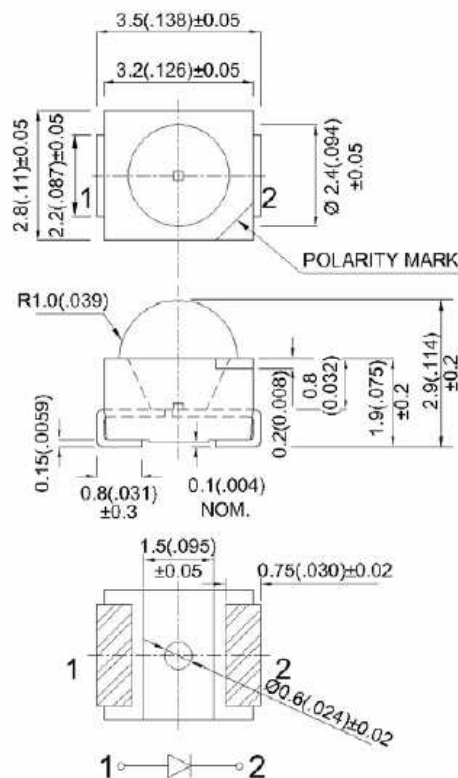

**Notes:**

1. All dimension units are millimeters (Inches)
2. All dimension tolerance ±0.2mm unless otherwise noted.
3. An epoxy meniscus may extend about 1.5mm down the leads.

**Selection Guide**

Part No.	Dice	lens type	IV(mcd)@20mA		Viewing Angle
			Min	Typ	2θ <sub>1/2</sub>
FYLS-3528GC	Green(GaP)	Water clear	22	40	120

**Electrical/Optical Characteristics at Ta=25 °c**

Symbol	Parameter	Device	min.	typ.	units	test conditions
λd	Dominate wavelength	Green	567	570	nm	IF=20mA
VF	Forward Voltage		1.6	2.0	V	IF=20mA
IR	Reverse Current			5	μA	VR=5V

**Absolute Maximum Ratings At= 25 °c**

Parameter	White	Units
Power dissipation	70	mW
DC Forward Current	25	mA
Peak Forward Current(1)	140	mA
Reverse Voltage	5	V
Operating/storage Temperature	-40°C to +85°C	

**Note:**

1. 1/10 Duty Cycle, 0.1ms Pulse Width.

**Reliability Test items And Conditions**

The reliability of products shall be satisfied with items listed below.

Confidence level:90% LTPD:10%

NO.	Items	test condition	test Hours/Cycles	sample Size	Ac/Rc
1	Reflow	Temp:240°C ± 5°C Min:5sec	6Min	22pcs	0/1
2	Temperature cycle	H: +100°C 15min.~5min L:-40°C ~ 15min	300 Cycles	22pcs	0/1
3	Thermal shock	H: +100°C 5min.~10sec. L:-10°C 5min	300 Cycles	22pcs	0/1
4	High Temperature Storage	temp:100°C	1000hrs.	22pcs	0/1
5	LOW Temperature Storage	temp:-55°C	1000hrs.	22pcs	0/1
6	DC Operating Life	IF=20mA	1000hrs.	22pcs	0/1
7	High Temperature /High Humidity	85°C/R,H80%	1000hrs.	22pcs	0/1

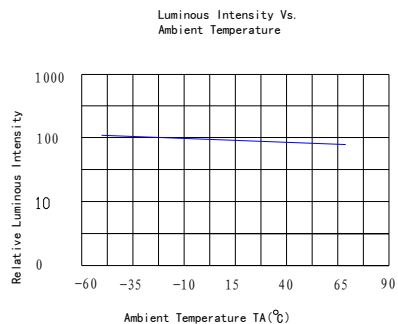
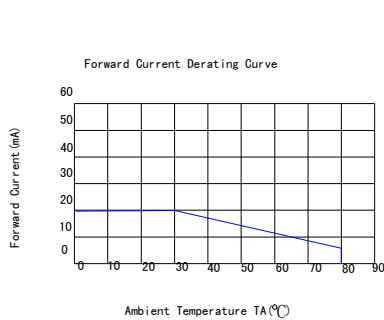
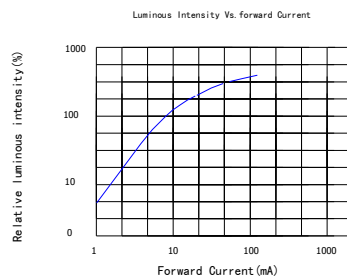
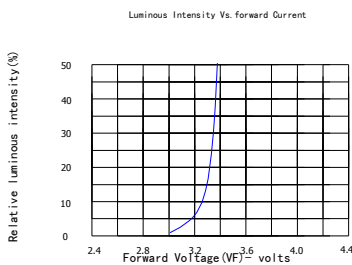
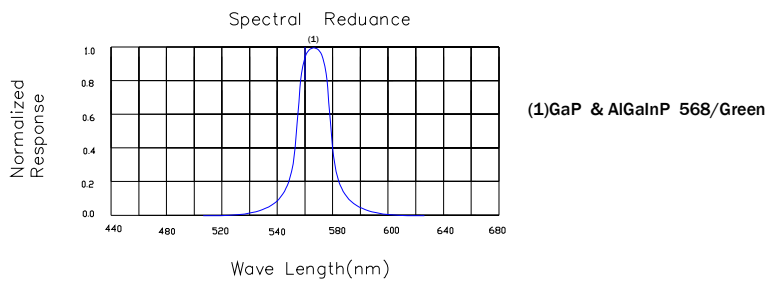

## SMT Reflow Soldering Instructions

Number of reflow process shall be less than 2 times and cooling

Process to normal temperature is required between first and second soldering process

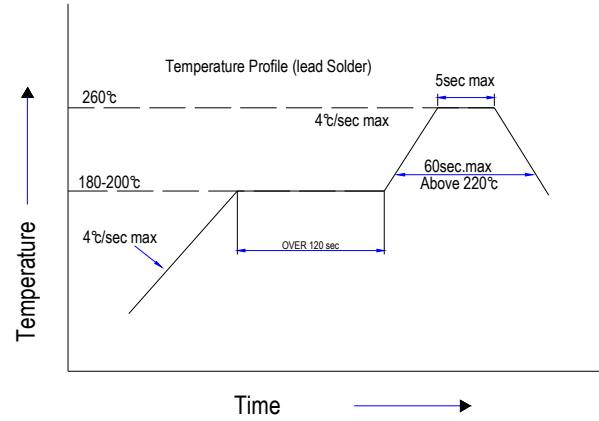
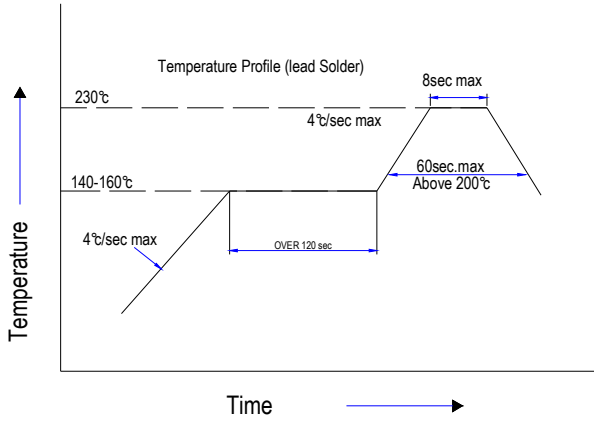

## Recommended Soldering Pattern(Units:mm)

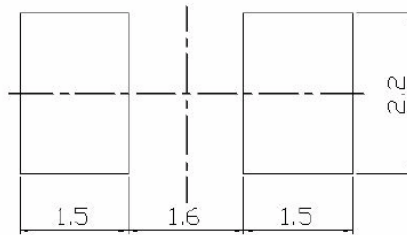

## Tape Specifications (Units : mm)

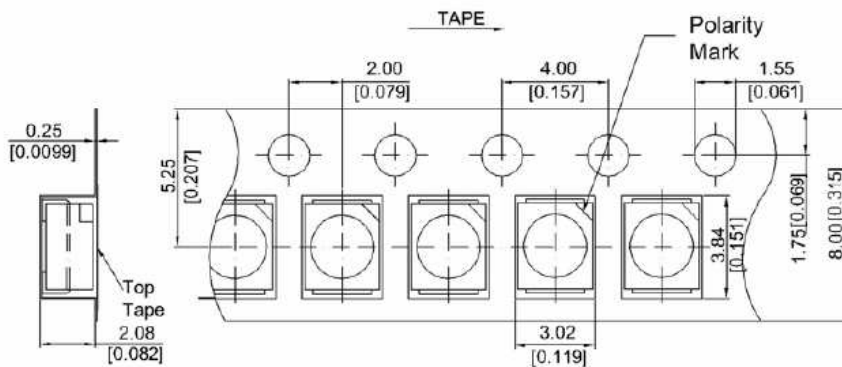

## ◆ Packing and Shipping Spec.

