

Single Phase Rectifier Bridge

PSB 55

I_{dAVM}
 V_{RRM}

= 50 A
= 800-1800 V

Preliminary Data Sheet

V_{RSM} V	V_{RRM} V	Type
800	800	PSB 55/08
1200	1200	PSB 55/12
1400	1400	PSB 55/14
1600	1600	PSB 55/16
1800	1800	PSB 55/18

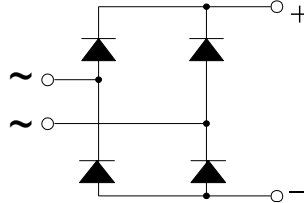

Symbol	Test Conditions	Maximum Ratings
I_{dAVM}	$T_C = 64^\circ\text{C}$, module	50 A
I_{FSM}	$T_{VJ} = 45^\circ\text{C}$ $V_R = 0$ $t = 10\text{ ms}$ (50 Hz), sine	750 A
	$t = 8.3\text{ ms}$ (60 Hz), sine	820 A
	$T_{VJ} = T_{VJM}$ $V_R = 0$ $t = 10\text{ ms}$ (50 Hz), sine	670 A
	$t = 8.3\text{ ms}$ (60 Hz), sine	740 A
$\int i^2 dt$	$T_{VJ} = 45^\circ\text{C}$ $V_R = 0$ $t = 10\text{ ms}$ (50 Hz), sine	2800 $\text{A}^2\text{ s}$
	$t = 8.3\text{ ms}$ (60 Hz), sine	2820 $\text{A}^2\text{ s}$
	$T_{VJ} = T_{VJM}$ $V_R = 0$ $t = 10\text{ ms}$ (50 Hz), sine	2250 $\text{A}^2\text{ s}$
	$t = 8.3\text{ ms}$ (60 Hz), sine	2300 $\text{A}^2\text{ s}$
T_{VJ}		-40 ... + 150 $^\circ\text{C}$
T_{VJM}		150 $^\circ\text{C}$
T_{stg}		-40 ... + 150 $^\circ\text{C}$
V_{ISOL}	50/60 HZ, RMS $t = 1\text{ min}$	2500 V ~
	$I_{ISOL} \leq 1\text{ mA}$ $t = 1\text{ s}$	3000 V ~
M_d	Mounting torque (M5)	5 Nm
	Terminal connection torque (M5)	3 Nm
Weight	typ.	200 g

Features

- Package with screw terminals
- Isolation voltage 3000 V~
- Planar glasspassivated chips
- Blocking voltage up to 1800 V
- Low forward voltage drop
- UL registered E 148688

Applications

- Supplies for DC power equipment
- Input rectifiers for PWM inverter
- Battery DC power supplies
- Field supply for DC motors

Advantages

- Easy to mount with two screws
- Space and weight savings
- Improved temperature and power cycling capability

Package, style and outline

Dimensions in mm (1mm = 0.0394")

Symbol	Test Conditions	Characteristic Value
I_R	$V_R = V_{RRM}$ $T_{VJ} = 25^\circ\text{C}$	$\leq 0.3\text{ mA}$
	$V_R = V_{RRM}$ $T_{VJ} = T_{VJM}$	$\leq 10.0\text{ mA}$
V_F	$I_F = 150\text{ A}$ $T_{VJ} = 25^\circ\text{C}$	$\leq 1.6\text{ V}$
V_{TO}	For power-loss calculations only	0.85 V
r_T	$T_{VJ} = T_{VJM}$	8 $\text{m}\Omega$
R_{thJC}	per diode; DC current	2.6 K/W
	per module	0.65 K/W
R_{thJK}	per diode; DC current	2.84 K/W
	per module	0.71 K/W
d_S	Creeping distance on surface	7.8 mm
d_A	Creeping distance in air	7.8 mm
a	Max. allowable acceleration	50 m/s^2

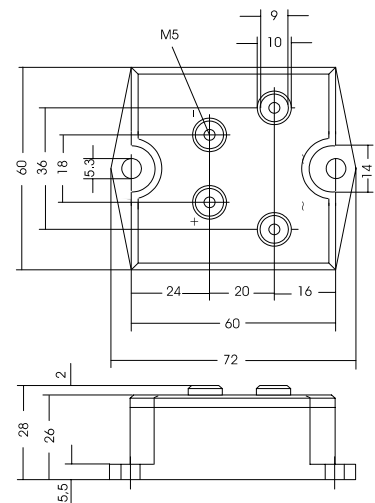

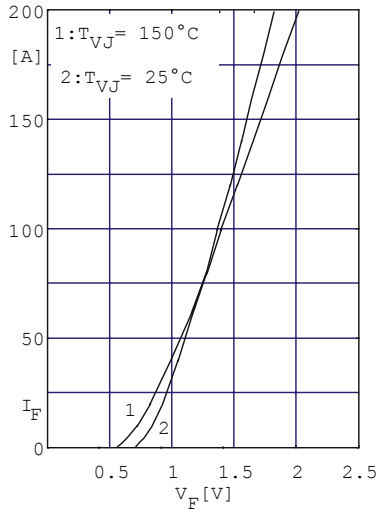

Fig. 1 Forward current versus voltage drop per diode

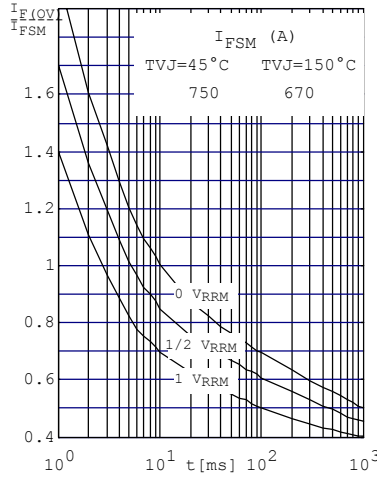

Fig. 2 Surge overload current per diode I_{FSM} : Crest value. t : duration

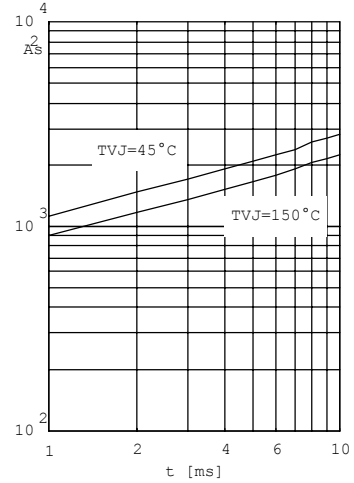

Fig. 3 $\int i^2 dt$ versus time (1-10ms) per diode (or thyristor)

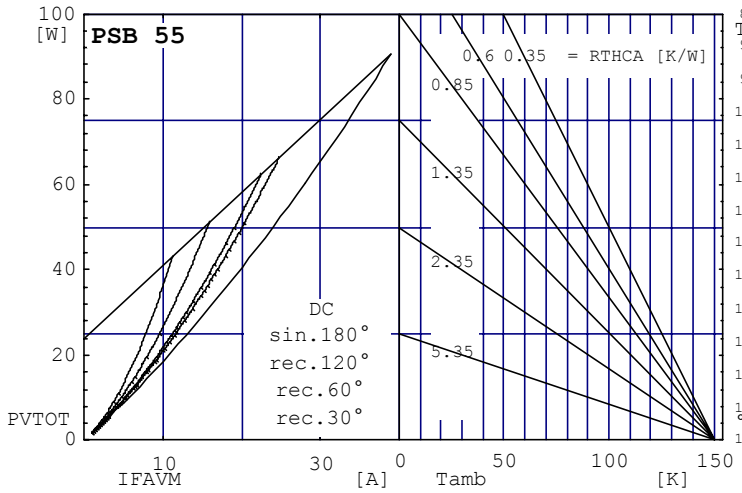

Fig. 4 Power dissipation versus direct output current and ambient temperature

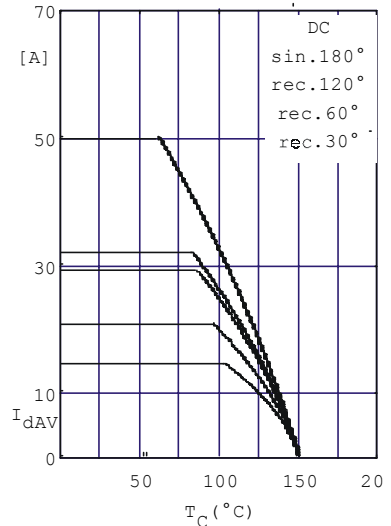

Fig.5 Maximum forward current at case temperature

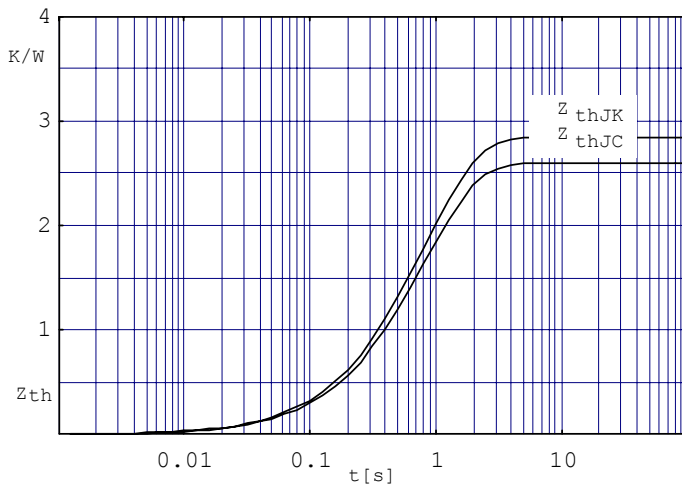

Fig. 6 Transient thermal impedance per diode (or thyristor), calculated