

Shape

KST-911RP/A
KST-931RP/A
KST-951RP/A



Model Number	KST-911RP/A	KST-931RP/A	KST-951RP/A
Rated Voltage (Vo-p)	1.5	3.0	5.0
Operating Voltage Range (Vo-p)	1.0 ~ 2.0	2.0 ~ 4.0	4.0 ~ 6.0
Current Consumption (mA)	Max. 80		
Coil Resistance (Ω)	6.0±1.0	15.0±2.3	30.0±4.5
Sound Pressure Level (dBA)	Min. 85dBA(Typical 91)@10cm		Min. 85dBA(Typical 92)@10cm
Rated Frequency (Hz)	2730		
Operating Temperature (°C)	-20 ~ +60		
Storage Temperature (°C)	-30 ~ +70		
Weight (Gram)	2.0		
Material	PPO		

Dimension

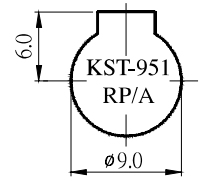
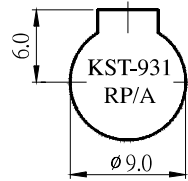
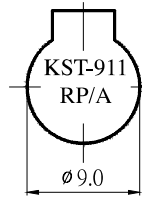
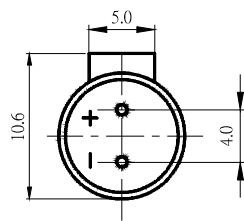
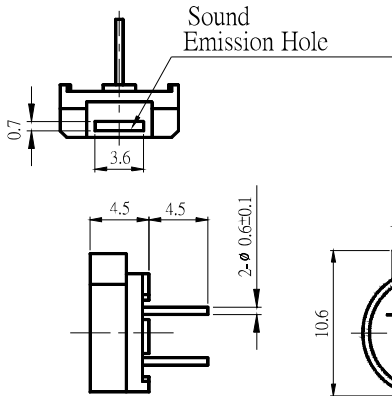

Tol: ±0.5 Unit : mm

Characteristic

KST-911RP/A

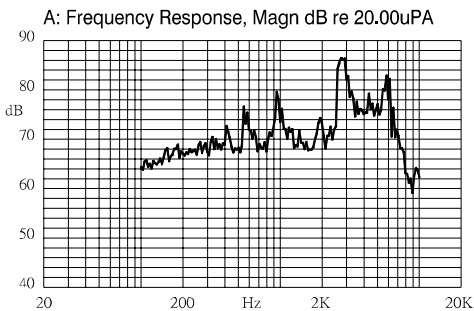

KST-931RP/A

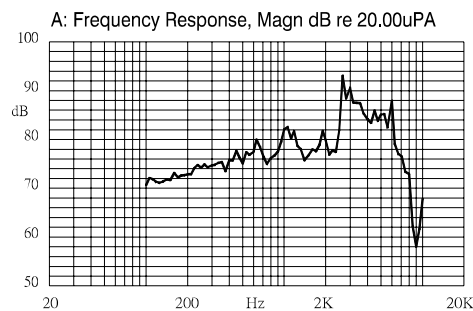

KST-951RP/A

