

INNOLUX DISPLAY CORPORATION

LCD MODULE

SPECIFICATION

Customer: _____

Model Name: PT035TN01 V.2

SPEC NO.: P035-01-TT-21



Date: 2005/10/12

Version: 1

- Preliminary Specification
 Final Specification

For Customer's Acceptance

Approved by	Comment

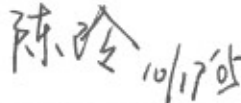
Approved by	Reviewed by	Prepared by
 10/17/05 10/17/05	 10/17/05	 10/17/05

The copyright belongs to InnoLux. Any unauthorized use is prohibited.

Record of Revision

Version	Revise Date	Page	Content
1	2005/10/12		Initial release

The copyright belongs to InnoLux. Any unauthorized use is prohibited.

Contents:

1. General Specifications	1
2. Pin Assignment	2
3. Operation Specifications	5
3.1. Absolute Maximum Rating	5
3.2. Electrical Characteristics	6
3.2.1. Typical Operation Conditions	6
3.2.2. Current Consumption	7
3.2.3. Backlight Driving Condition	7
3.3. Timing Characteristics	8
3.3.1. Timing Conditions	8
3.3.2. Timing Diagram	10
4. Optical Specifications.....	12
5. Reliability Test Items	16
6. Handling Precautions.....	17
6.1. Safety	17
6.2. Handling	17
6.3. Static Electricity	17
6.4. Storage.....	17
6.5. Cleaning	17
7. Mechanical Drawing	18
8. Package Drawing.....	19

1. General Specifications

No.	Item	Specification	Remark
1	LCD size	3.5" inch	
2	Driver element	a-Si TFT active matrix	
3	Resolution	320X3(RGB)X240	
4	Display mode	Normally White, Transmissive with Micro Reflective	
5	Dot pitch	0.073(W)X0.219(H) mm	
6	Active area	70.08(W)X52.56(H) mm	
7	Module size	78.2(W)X65.0(H)X3.5(D) mm	Note 1
8	Surface treatment	Anti Glare	
9	Color arrangement	RGB-stripe	
10	Interface	Digital	
11	Backlight power consumption	0.44W(Typ.)	
12	Panel power consumption	TBD	
13	Weight	TBD	

Note 1: Refer to Mechanical Drawing.

2. Pin Assignment

Pin No.	Symbol	I/O	Function	Remark
1	GLED	P	GND for LED	
2	GLED	P	GND for LED	
3	VLED	P	Power for LED	
4	VLED	P	Power for LED	
5	GND	P	Ground	
6	NC	I	No connect	
7	NC	I	No connect	
8	NC	I	No connect	
9	NC	I	No connect	
10	GND	P	Ground	
11	NC	-	No connect	
12	NC	-	No connect	
13	POL	I	Polarity select for the line inversion control signal.	
14	RESET	I	Reset	
15	SPENA	I	Serial port data enable signal. Normally pull high.	
16	SPCK	I	Serial port clock .Normally pull high.	
17	SPDA	I/O	Serial port data input/output.	
18	D00	I	Blue data(LSB)	
19	D01	I	Blue data	
20	D02	I	Blue data	
21	D03	I	Blue data	
22	D04	I	Blue data	
23	D05	I	Blue data	

24	D06	I	Blue data	
25	D07	I	Blue data(MSB)	
26	D08	I	Green data(LSB)	
27	D09	I	Green data	
28	D10	I	Green data	
29	D11	I	Green data	
30	D12	I	Green data	
31	D13	I	Green data	
32	D14	I	Green data	
33	D15	I	Green data(MSB)	
34	D16	I	Red data(LSB)	
35	D17	I	Red data	
36	D18	I	Red data	
37	D19	I	Red data	
38	D20	I	Red data	
39	D21	I	Red data	
40	D22	I	Red data	
41	D23	I	Red data(MSB)	
42	IHS	I	Horizontal synchronous signal	
43	IVS	I	Vertical synchronous signal	
44	CLK	I	Data clock	
45	AV _{DD}	P	Analog power supply(+5V)	
46	AV _{DD}	P	Analog power supply(+5V)	
47	V _{CC}	P	Digital power supply(+3.3V)	
48	V _{CC}	P	Digital power supply(+3.3V)	
49	NC	-	No connect	
50	V _{GL}	I	Negative power for scan driver	

51	V _{GL}	I	Negative power for scan driver	
52	NC	-	No connect	
53	V _{GH}	I	Positive power for scan driver	
54	NC	-	No connect	
55	NC	-	No connect	
56	V _{COM}	I	V _{COM} input	
57	V _{COM}	I	V _{COM} input	
58	DEN	I	Data enabling signal	
59	GND	P	Ground	
60	GND	P	Ground	

3. Operation Specifications

3.1. Absolute Maximum Rating

(GND =0V, Note 1)

Item	Symbol	Values		Unit	Remark
		Min.	Max.		
Power voltage	V _{CC}	-0.3	7	V	
	A _V _{DD}	-0.3	7	V	
	V _{GH}	-0.3	18	V	
	V _{GL}	-15	0.3	V	
	V _{GH} -V _{GL}	-	33	V	
Operation Temperature	T _{OP}	-20	70	°C	
Storage Temperature	T _{ST}	-30	80	°C	

Note 1: Device is subject to be damaged permanently if stresses beyond those absolute maximum ratings listed above.

3.2. Electrical Characteristics

3.2.1. Typical Operation Conditions

(GND =0V, Note 3)

Item	Symbol	Values			Unit	Remark
		Min.	Typ.	Max.		
Power voltage	V_{CC}	3.0	3.3	3.6	V	
	AV_{DD}	-	5.0	-	V	
	V_{GH}	-	TBD	-	V	
	V_{GL}	-	TBD	-	V	
V_{COM}	V_{CAC}	-	TBD	-	V	Note 1
	V_{CDC}	-	TBD	-	V	Note 2 DC component
Input logic high voltage	V_{IH}	$0.7V_{CC}$	-	V_{CC}	V	
Input logic low voltage	V_{IL}	0	-	$0.3V_{CC}$	V	

Note 1: The brightness of LCD panel could be changed by adjusting the AC component of V_{COM} .

Note 2: The voltage of V_{CDC} must be adjustable from 0V to 3V.

Note 3: Be sure to apply GND, V_{CC} , and V_{GL} , to the LCD first, and then apply V_{GH} .

3.2.2. Current Consumption

(GND =0V)

Item	Symbol	Values			Unit	Remark
		Min.	Typ.	Max.		
Current for Driver	I_{GH}	-	TBD	-	mA	$V_{GH} = TBD$
	I_{GL}	-	TBD	-	mA	$V_{GL} = TBD$
	I_{CC}	-	TBD	-	mA	$V_{CC} = 3.3V$
	I_{DD}	-	TBD	-	mA	$AV_{DD} = 5V$

3.2.3. Backlight Driving Condition

Item	Symbol	Values			Unit	Remark
		Min.	Typ.	Max.		
LED voltage	V_L	-	(21.6)	-	V	Note 1
LED current	I_L	-	(20)	-	mA	Note 1
LED life time	-	10,000	-	-	Hr	Note 2

Note 1: The LED driving condition is defined for each LED module. (See the figure)

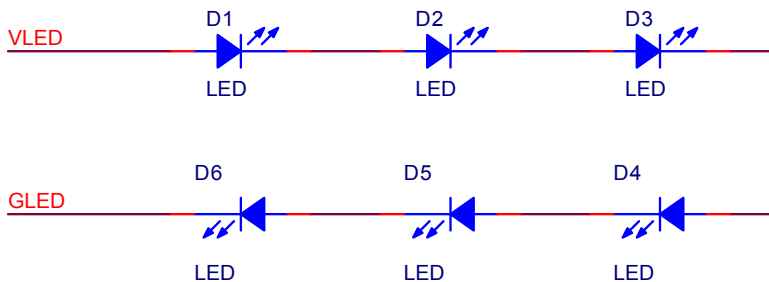

Note 2: The “LED life time” is defined as the module brightness decrease to 50% original brightness that the ambient temperature is 25°C and $I_L = 20mA$.

3.3. Timing Characteristics

3.3.1. Timing Conditions

Digital Parallel RGB Interface

Item	Symbol	Values			Unit.	Remark	
		Min.	Typ.	Max.			
CLK period	T _{OSC}	-	156	-	ns		
Data setup time	T _{SU}	12	-	-	ns		
Data hold time	T _{HD}	12	-	-	ns		
IHS period	T _H	-	408	-	T _{OSC}		
IHS pulse width	T _{HS}	5	30	-	T _{OSC}		
IVS pulse width	T _{VS}	1	3	5	T _H		
IVS-DEN time	NTSC	T _{VSE}	-	18	-	T _H	
	PAL		-	26			
IHS-DEN time	T _{HE}	36	68	88	T _{OSC}		
DEN pulse width	T _{EP}	-	320	-	T _{OSC}		

Hardware reset timing

Item	Symbol	Values			Unit.	Remark
		Min.	Typ.	Max.		
RESET low pulse width	T _{RSB}	10	-	-	μs	

SPI timing characteristics

Item	Symbol	Values			Unit	Remark
		Min.	Typ.	Max.		
SPCK period	T_{CK}	60	-	-	ns	
SPCK high width	T_{CKH}	30	-	-	ns	
SPCK low width	T_{CKL}	30	-	-	ns	
Data setup time	T_{SU1}	12	-	-	ns	
Data hold time	T_{HD1}	12	-	-	ns	
SPENA to SPCK setup time	T_{CS}	20	-	-	ns	
SPENA to SPDA hold time	T_{CE}	20	-	-	ns	
SPENA high pulse width	T_{CD}	50	-	-	ns	
SPDA output latency	T_{CR}	-	1/2	-	T_{CK}	

3.3.2. Timing Diagram

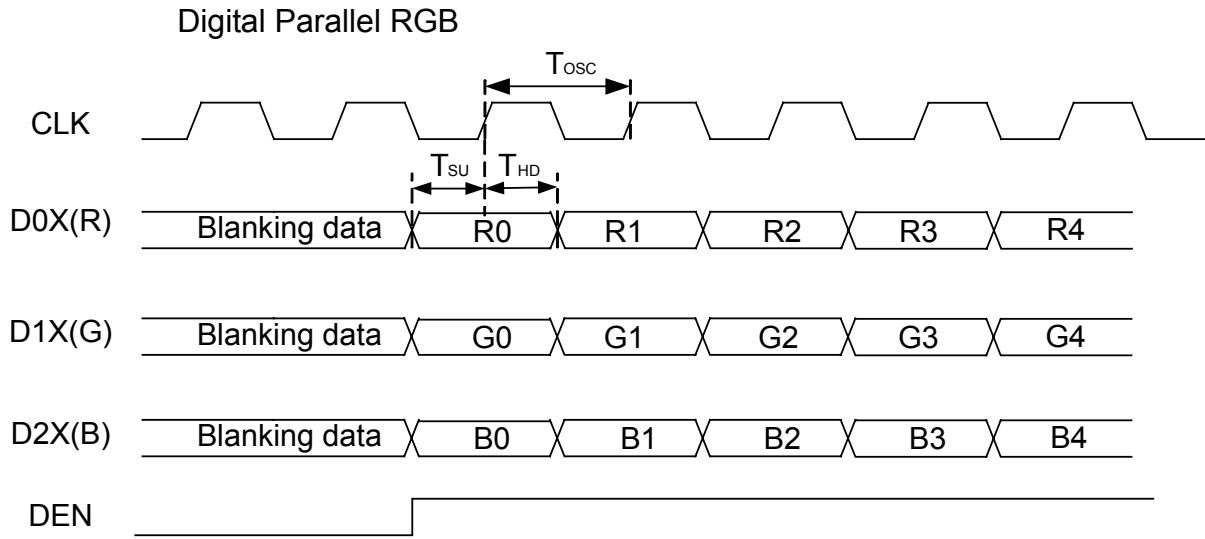

IHS and horizontal control timing waveform

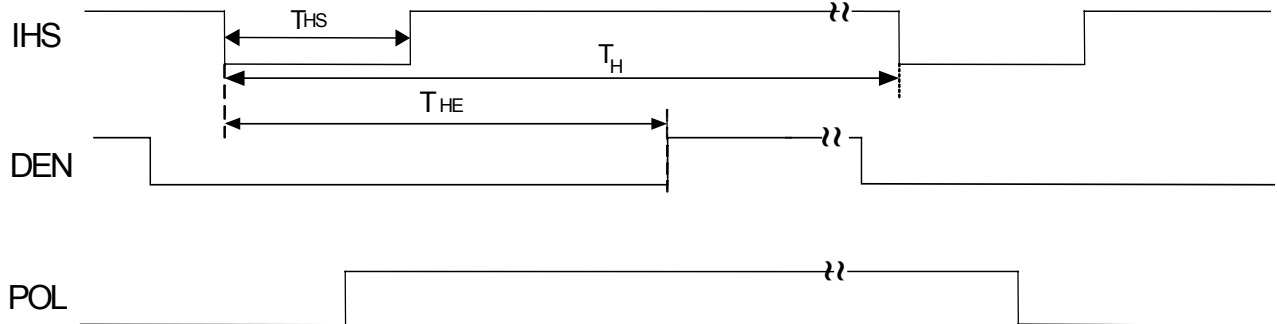

IHS and vertical control timing waveform

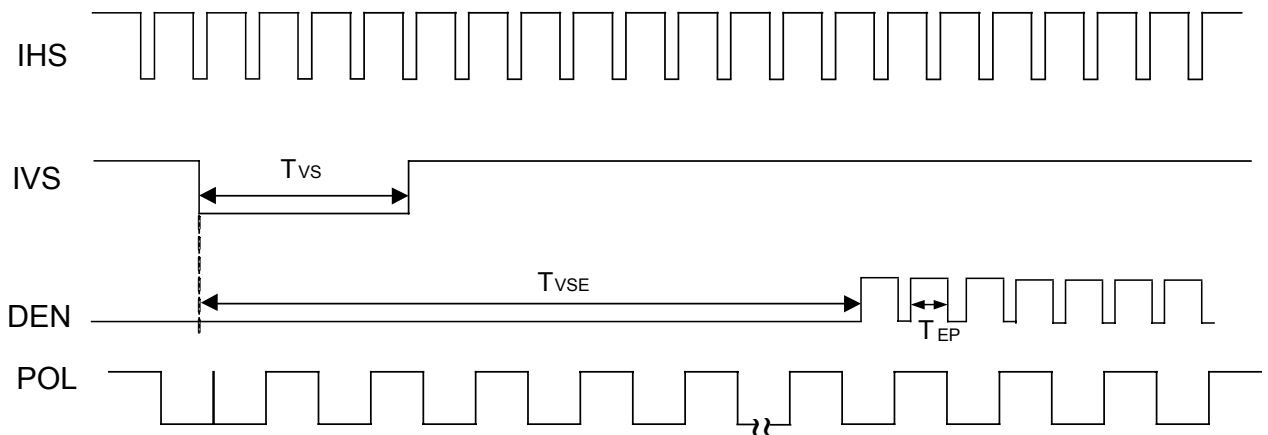

SPI "read" timing

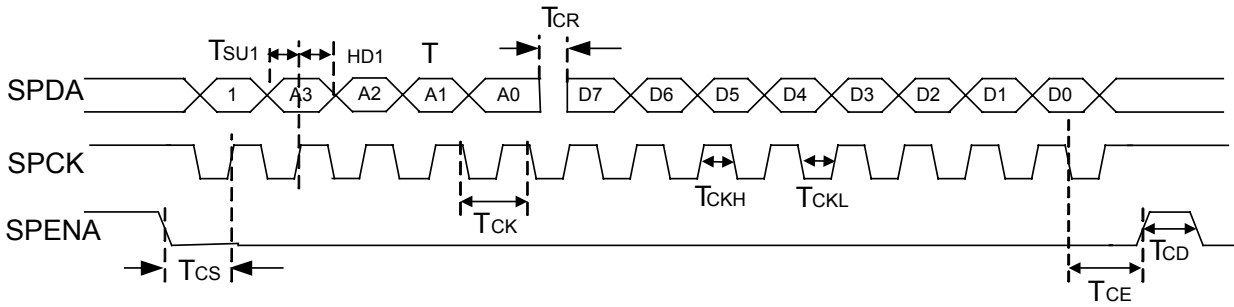

SPI "write" timing

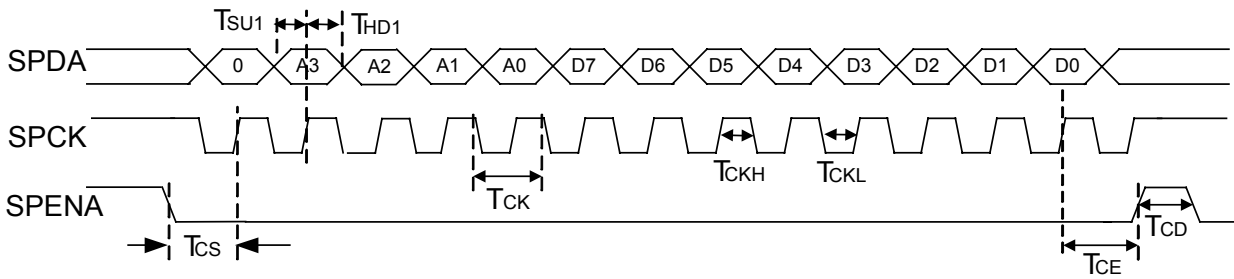

4. Optical Specifications

Item	Symbol	Condition	Min.	Typ.	Max.	Unit	Remark
Viewing angle (CR≥10)	θ_L	$\Phi=180^\circ$ (9 o'clock)	55	65	-	degree	Note 1
	θ_R	$\Phi=0^\circ$ (3 o'clock)	55	65	-		
	θ_T	$\Phi=90^\circ$ (12 o'clock)	35	45	-		
	θ_B	$\Phi=270^\circ$ (6 o'clock)	55	65	-		
Response Time	T_{ON}	Normal $\theta=\Phi=0^\circ$	-	15	30	msec	Note 3
	T_{OFF}		-	20	50	msec	Note 3
Contrast ratio	CR		200	300	-	-	Note 4
Color chromaticity	W_X		-	TBD	-	-	Note 5
	W_Y		-	TBD	-	-	Note 6
Luminance	L		200	250	-	cd/m ²	Note 6
Luminance uniformity	Y_U		70	75	-	%	Note 7

Test Conditions:

- $V_{CC}=3.3V$, $AV_{DD}=5.0V$, $I_L=20mA$ (Backlight current), the ambient temperature is 25°C.
- The test systems refer to Note 2.

Note 1: Definition of viewing angle range

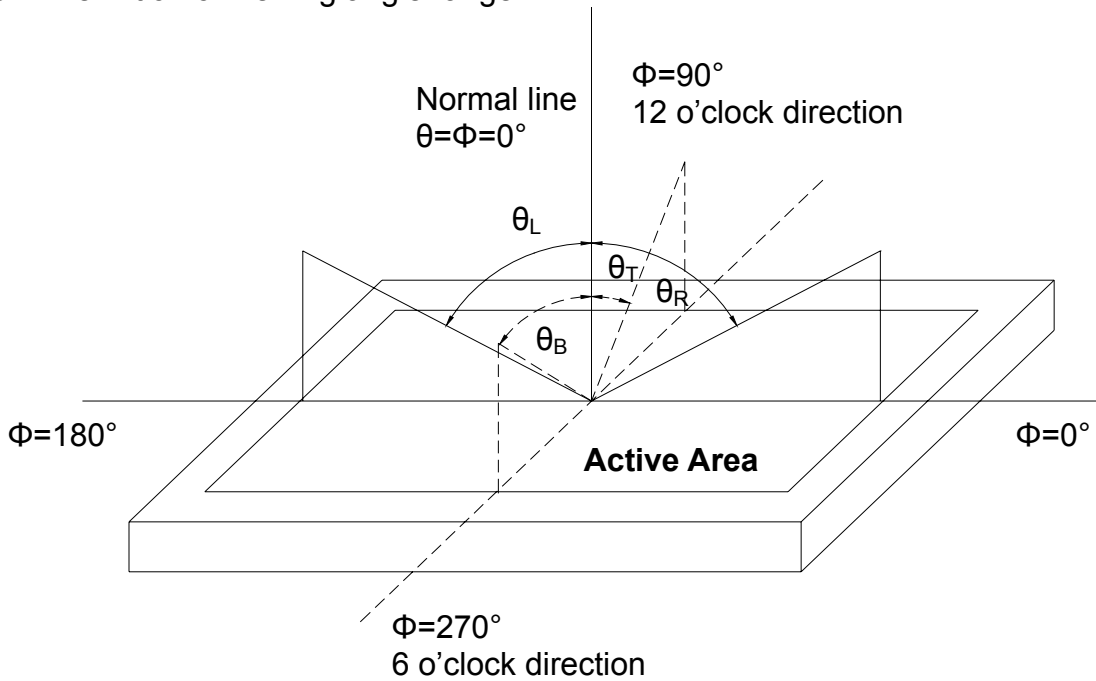

Fig. 5-1 Definition of viewing angle

Note 2: Definition of optical measurement system.

The optical characteristics should be measured in dark room. The optical properties are measured at the center point of the LCD screen. (Response time is measured by Photo detector TOPCON BM-7, other items are measured by BM-5A/Field of view: 1° /Height: 500mm.)

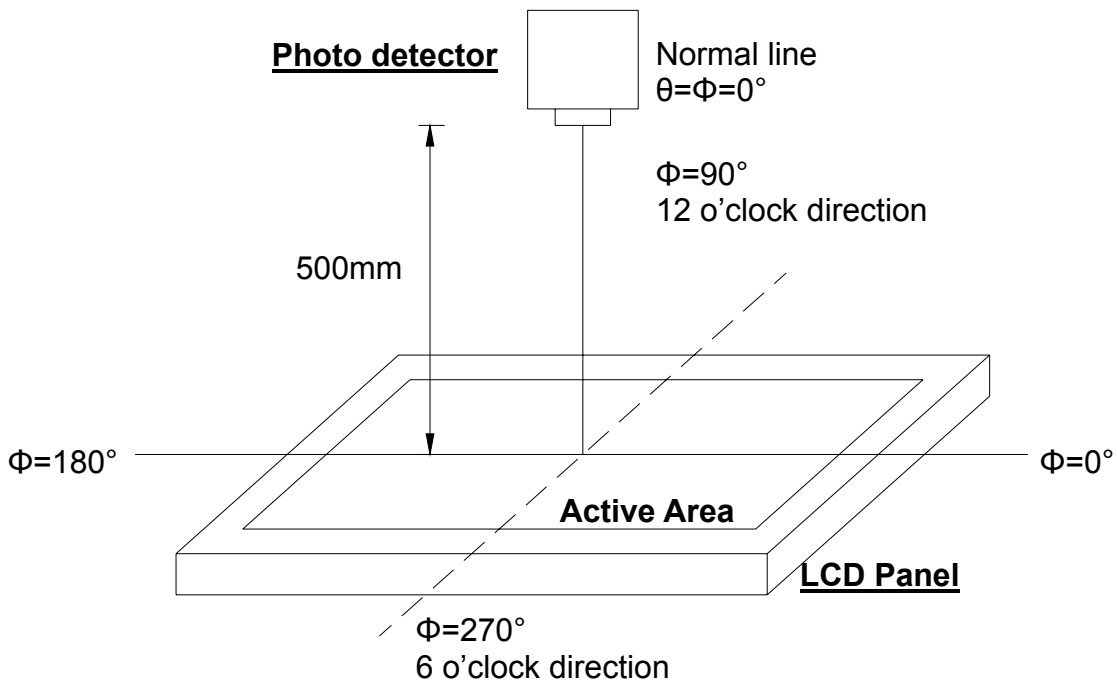

Fig. 5-2 Optical measurement system setup

The copyright belongs to InnoLux. Any unauthorized use is prohibited.

Note 3: Definition of Response time

The response time is defined as the LCD optical switching time interval between "White" state and "Black" state. Rise time (T_{ON}) is the time between photo detector output intensity changed from 90% to 10%. And fall time (T_{OFF}) is the time between photo detector output intensity changed from 10% to 90%.

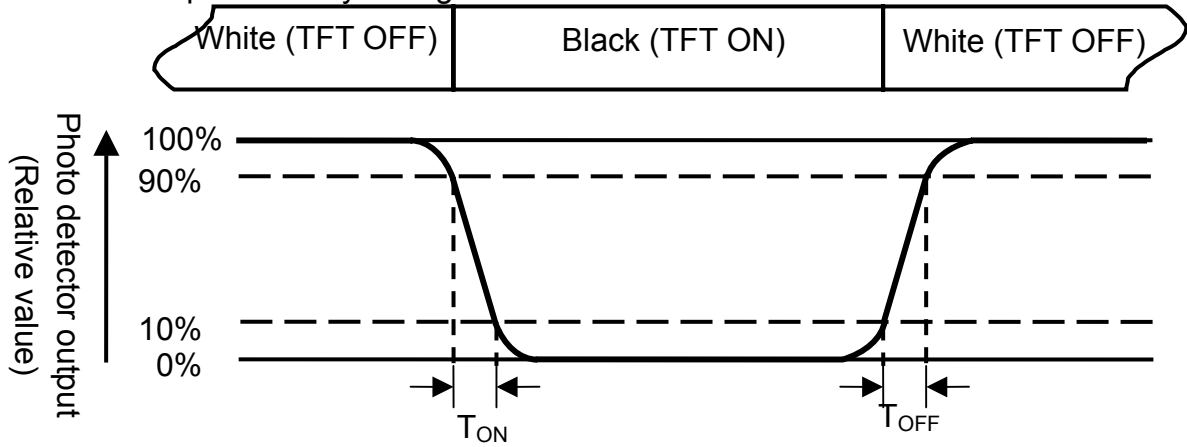

Fig. 5-3 Definition of response time

Note 4: Definition of contrast ratio

$$\text{Contrast ratio (CR)} = \frac{\text{Luminance measured when LCD is on the "White" state}}{\text{Luminance measured when LCD is on the "Black" state}}$$

Note 5: Definition of color chromaticity (CIE1931)

Color coordinates measured at center point of LCD.

Note 6: All input terminals LCD panel must be ground when measuring the center area of the panel.

Note 7: Definition of Luminance Uniformity

To test for uniformity, the tested area, which is inside the active area, is divided into 3 rows and 3 columns. The measurement spot is placed at the center of each box.

$$\text{Luminance Uniformity } (Yu) = \frac{B_{min}}{B_{max}}$$

L-----Active area length W----- Active area width

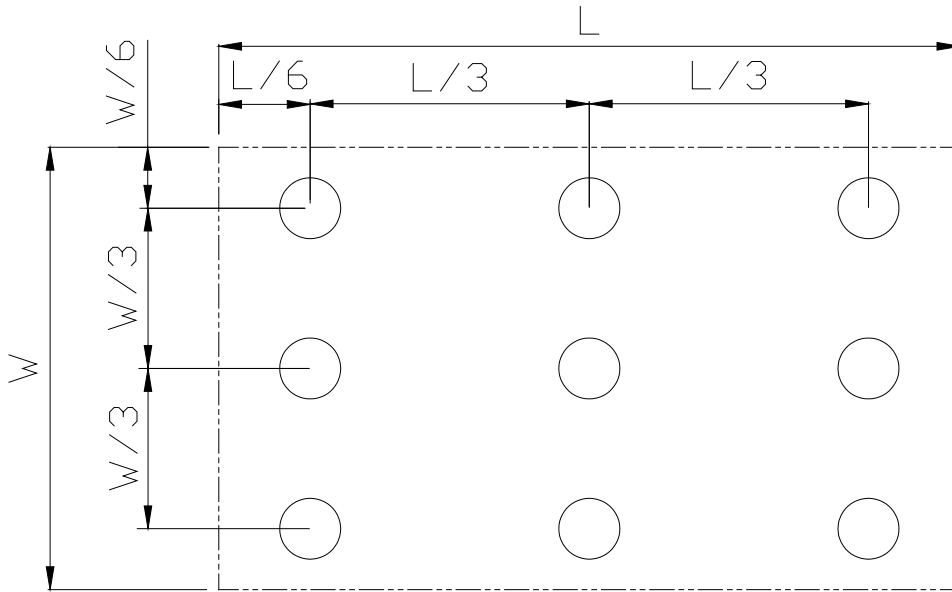

Fig. 5-4 Definition of uniformity

B_{max}: The measured maximum luminance of all measurement position.

B_{min}: The measured minimum luminance of all measurement position.

5. Reliability Test Items

Item	Test Conditions	Remark
High Temperature Storage	Ta = 80°C 240 hrs	Note 1
Low Temperature Storage	Ta = -30°C 240hrs	Note 1
High Temperature Operation	Ts = 70°C 240hrs	Note 2
Low Temperature Operation	Ta = -20°C 240hrs	Note 1
Operate at High Temperature and Humidity	+40°C, 90%RH max. 240 hrs	
Thermal Shock	-30°C/30 min ~ +80°C/30 min for a total 100 cycles, Start with cold temperature and end with high temperature	
Vibration Test	Frequency range:10~55Hz Stroke:1.5mm Sweep:10Hz~55Hz~10Hz 2 hours for each direction of X. Y. Z. (6 hours for total)	
Mechanical Shock	100G 6ms,±X, ±Y, ±Z 3 times for each direction	
Package Vibration Test	Random Vibration : 0.015G*G/Hz from 5-200HZ, -6dB/Octave from 200-500HZ 2 hours for each direction of X. Y. Z. (6 hours for total)	
Package Drop Test	Height:60 cm 1 corner, 3 edges, 6 surfaces	
Electro Static Discharge	± 2KV, Human Body Mode, 100pF/1500Ω	

Note 1: Ta is the ambient temperature of samples.

Note 2: Ts is the temperature of panel's surface.

Note 3: In the standard condition, there shall be no practical problem that may affect the display function.

6. Handling Precautions

6.1. Safety

Liquid crystal is poisonous. Do not put it in your mouth. If liquid crystal touches your skin or clothes, wash it off immediately by using soap and water.

6.2. Handling

1. The LCD panel is plate glass. Do not subject the panel to mechanical shock or to excessive force on its surface.
2. The polarizer attached to the display is easily damaged. Please handle it carefully to avoid scratch or other damages.
3. To avoid contamination on the display surface, do not touch the module surface with bare hands.
4. Keep a space so that the LCD panels do not touch other components.
5. Put cover board such as acrylic board on the surface of LCD panel to protect panel from damages.
6. Transparent electrodes may be disconnected if you use the LCD panel under environmental conditions where the condensation of dew occurs.
7. Do not leave module in direct sunlight to avoid malfunction of the ICs.

6.3. Static Electricity

1. Be sure to ground module before turning on power or operating module.
2. Do not apply voltage which exceeds the absolute maximum rating value.

6.4. Storage

1. Store the module in a dark room where must keep at $+25\pm 10^{\circ}\text{C}$ and 65%RH or less.
2. Do not store the module in surroundings containing organic solvent or corrosive gas.
3. Store the module in an anti-electrostatic container or bag.

6.5. Cleaning

1. Do not wipe the polarizer with dry cloth. It might cause scratch.
2. Only use a soft cloth with IPA to wipe the polarizer, other chemicals might permanent damage to the polarizer.

7. Mechanical Drawing

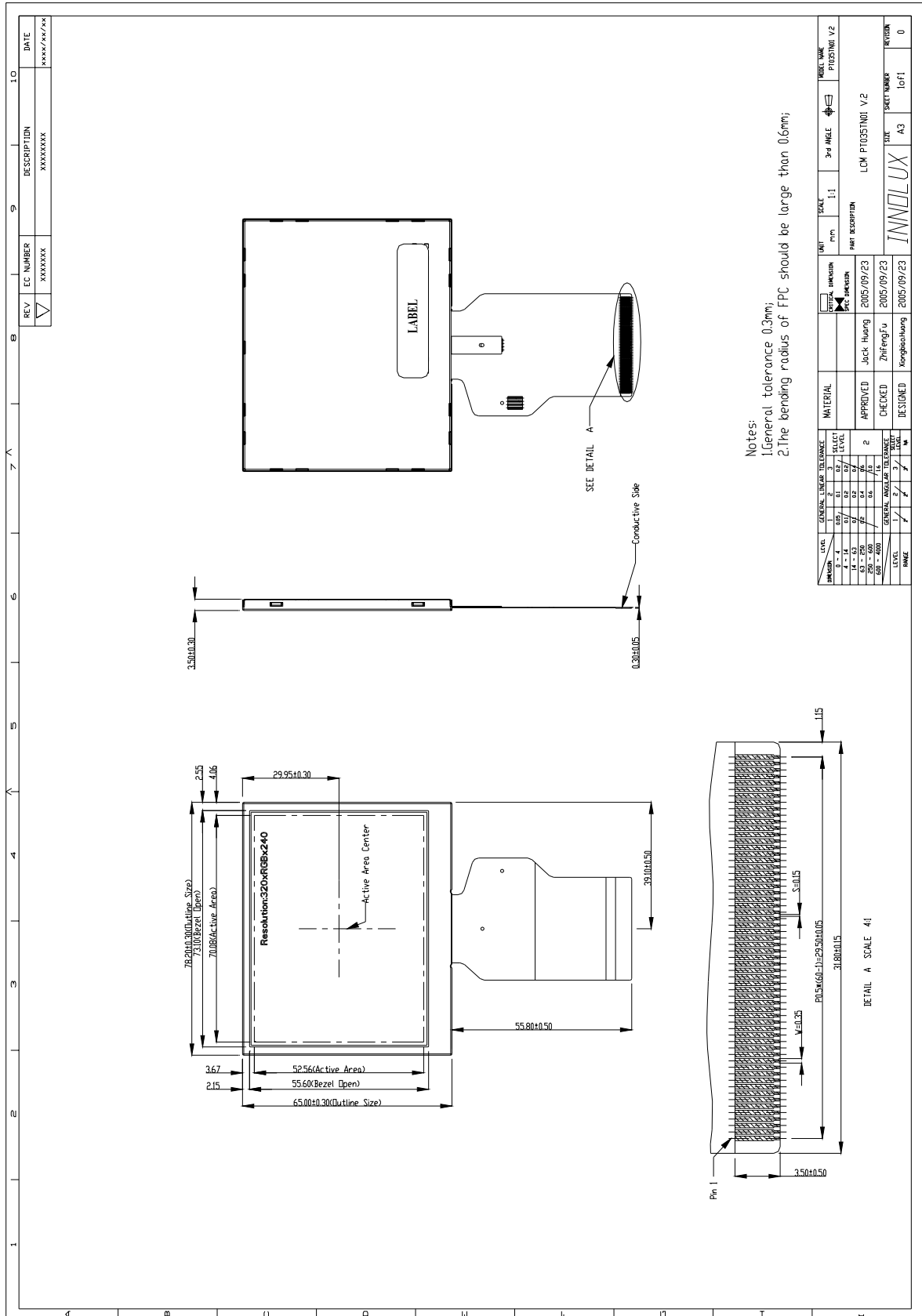

8. Package Drawing

TBD

<http://www.BDTIC.com/Innolux>

<http://www.BDTIC.com/INNOLUX>