



# MAX11811 Touch Evaluation System (TEVS)

## General Description

The MAX11811 touch evaluation system (TEVS) demonstrates the rich features of the MAX11811 touch-screen controller (TSC) and allows its evaluation. The TEVS consists of a USB interface board (UTIBB+), MAX11811 evaluation kit (EV kit), and a 4-wire touch sensor mounted with an linear resonant actuator (LRA) motor (USB cable included).

The device is a complete resistive touch-sensor controller solution that targets touch-enabled devices with small- to medium-size displays. The device enables miniaturization of consumer products due to its ultra-small size. Its low power consumption makes it attractive for portable devices.

The TEVS with haptics operates directly from the USB power. Windows XP® and Windows® 7-compatible software running on a PC interfaces to the TEVS board through the computer's USB communications port. See the *Quick Start* section for setup and operating instructions.

The EV kit daughter board provides a proven PCB layout to facilitate evaluation of the device and must be interfaced to the appropriate I<sup>2</sup>C timing signals for proper operation. See Figures 15, 16a, and 16b for connections and appropriate voltage levels. Refer to the MAX11811 IC data sheet for timing requirements and register addresses.

## EV System Contents List

QTY	DESCRIPTION
1	Software and driver CD-ROM.
1*	EV kit daughter board (with the TSC mounted on it, but can be separated from the TEVS for evaluation of the TSC in the user setup).
1*	USB interface board (UTIBB+). This acts as a gateway converting and accepting data from the USB port to I <sup>2</sup> C for the EV kit. The EV kit plugs into the UTIBB+.
1*	4-wire touch sensor mounted with an LRA motor.
1	USB cable for power and communication.

\*Mounted on a 0.125in x 3.5in x 9in Plexiglas base.

Windows and Windows XP are registered trademarks of Microsoft Corp.



## Features

### Hardware

- ◆ Complete Evaluation System Including USB-to-Serial Interface (I<sup>2</sup>C) Board
- ◆ Convenient Test Points Provided On-Board for Digital Interface and Analog Signals
- ◆ Interfaces to Common 4-Wire Resistive Touch Sensors through Standard FPC Connectors
  - 1.25mm Pitch
  - 1mm Pitch
  - 0.5mm Pitch
- ◆ Built-In LDOs and Level Translators for Operation with 1.8V, 3.0V, and 3.6V
- ◆ IR-Based Driver and Proximity Sensor Included\*\*
- ◆ Integrated Haptic Controller and Driver Motor for Motor-Based Haptic Feedback

### Software

- ◆ User-Friendly GUI Interface (Microsoft Windows XP and Windows 7-Compatible USB Interface and Drivers)
- ◆ Easy Access to TSC Configuration Registers and Status Registers
- ◆ Direct and Autonomous Conversion-Mode Demonstration Capability
- ◆ Ability to Capture Raw Data and Display the Data in Either Conversion Mode
- ◆ Pseudo Multi-Touch Demonstration

## Ordering Information

PART	TYPE	INTERFACE TYPE
MAX11811TEVS+	EV System	I <sup>2</sup> C

+Denotes lead(Pb)-free and RoHS compliant.

\*\*The GUI does not support this feature.

Evaluates: MAX11811

# MAX11811 Touch Evaluation System (TEVS)

## MAX11811TEVS+ Block Diagram

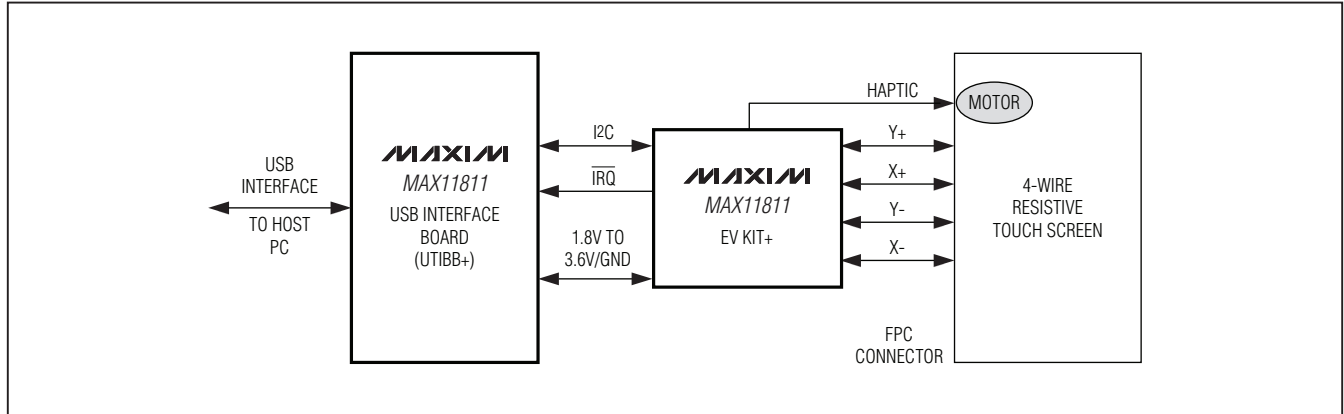

## Component Lists

### MAX11811 Interface Board

DESIGNATION	QTY	DESCRIPTION
A0/CSB, A1/DOUT, CSB, EN1B, EN2B, GND100, GND101, GND102, GPIO_K1-GPIO_K8, MISO, P1_4-P1_7, P3_4-P3_7, PIRQB, SCL, SCL/CLK, SCLK, SDA, SDA/DIN, TIRQB, U2-PIN1, U2-PIN20	34	Test points
C1, C2, C11, C13	4	1 $\mu$ F $\pm$ 10%, 16V X5R ceramic capacitors (0603) TDK C1608X5R1C105K
C3, C6, C12, C14	4	10 $\mu$ F $\pm$ 20%, 6.3V X5R ceramic capacitors (0603) TDK C1608X5R0J106M
C4, C5, C9, C10, C15-C19, C23, C24, C25	12	0.1 $\mu$ F $\pm$ 10%, 50V X7R ceramic capacitors (0603) TDK C1608X7R1H104K
C7, C8	2	22pF $\pm$ 5%, 50V C0G ceramic capacitors (0603) TDK C1608C0G1H220J

DESIGNATION	QTY	DESCRIPTION
C20, C21	2	10pF $\pm$ 5%, 50V C0G ceramic capacitors (0603) TDK C1608C0G1H100J
C22	1	33000pF $\pm$ 10%, 16V X5R ceramic capacitor (0603) Taiyo Yuden EMK107BJ333KA
C26, C27, C28	0	Not installed, capacitors
FB1, FB2	2	1.5A, 26 $\Omega$ ferrite beads (1206) Steward MI1206K260R-10
GND103, GND104	2	Loops for test with 2 vias (use 20AWG wire to make loops)
J1-J5, J11-J17, J22	0	Not installed, headers
J6, J7	2	2-pin headers
J8, J9, J18, J19	4	3-pin headers
J10	1	21-position SMD female connector Hirose DF9-21S-1V(32)
J20	1	5-position mini-USB connector Hirose UX60A-MB-5ST

# MAX11811 Touch Evaluation System (TEVS)

## Component Lists (continued)

### MAX11811 Interface Board (continued)

DESIGNATION	QTY	DESCRIPTION
J21	1	Dual-row JTAG header, 0.1in centers, gold plated
LED2, LED3, LED4	3	RGB clear LEDs (0805) Lumex Opto SML-LX0805SIC
R1, R2	2	4.7k $\Omega$ resistors (0805)
R3, R4, R10, R19, R32–R39, R40, R41	0	Not installed, resistors
R5	1	196k $\Omega$ $\pm$ 1% resistor (0805)
R6	1	590k $\Omega$ $\pm$ 1% resistor (0805)
R7	1	61.9k $\Omega$ $\pm$ 1% resistor (0805)
R8, R22	2	100k $\Omega$ $\pm$ 1% resistors (0805)
R20	1	100k $\Omega$ resistor (0805)
R9, R16, R17	3	215 $\Omega$ resistors (0805)
R11–R14	4	0 $\Omega$ resistors (0805)
R15, R18	2	51k $\Omega$ resistors (0805)
R21	1	169k $\Omega$ $\pm$ 1% resistor (0805)
R23, R24	2	27 $\Omega$ resistors (0805)
R25	1	1.5k $\Omega$ resistor (0805)
R26	1	2.2k $\Omega$ resistor (0805)
R27	1	470 $\Omega$ resistor (0805)
R28	1	10k $\Omega$ resistor (0805)
R29, R30, R31	3	3.3k $\Omega$ resistors (0805)
U1, U7	2	Adjustable output LDO regulators (5 SC70) Maxim MAX8512EXK+
U2	1	8-channel level translator (20 TSSOP) Maxim MAX3001EEUP+

DESIGNATION	QTY	DESCRIPTION
U3	1	LDO regulator (5 SC70) Maxim MAX8511EXK25+
U4	1	USB-to-serial UART (32 LQFP) FTDI FT232BL
U5	1	1Kb, 1.8V SRL EEPROM (8 SO) Atmel AT93C46EN-SH-B
U6	1	Microcontroller (68 QFN-EP*) Maxim MAXQ2000-RAX+
U8	1	Octal-level translator (12 TQFN-EP*) Maxim MAX3395EETC+
U9	0	Not installed
Y1	1	16MHz crystal ECS ECS-160-20-5PXDN-TR
Y2	1	6MHz crystal ECS ECS-60-20-5G3XDS-TR
Y3	0	Not installed, crystal
—	5	Bumpers (rubber feet, on bottom of board) 3M SJ-5306 (clear)
—	4	Shunts (J8, J9, J18, and J19) Sullins STC02SYAN

\*EP = Exposed pad.

Evaluates: MAX11811

# MAX11811 Touch Evaluation System (TEVS)

Evaluates: MAX11811

## MAX11811 EV Kit Daughter Board

DESIGNATION	QTY	DESCRIPTION
C1–C5	0	Not installed, capacitors
C6, C9	2	10 $\mu$ F $\pm$ 20%, 6.3V X5R ceramic capacitors (0603) TDK C1608X5R0J106M
C7	1	0.1 $\mu$ F $\pm$ 10%, 50V X7R ceramic capacitor (0603) Murata GRM188R71H104K
C8	1	220pF $\pm$ 5%, 50V C0G ceramic capacitor (0603) TDK C1608C0G1H221J
C10	1	1 $\mu$ F $\pm$ 10%, 25V X5R ceramic capacitor (0603) TDK C1608X5R1E105K
GND, GND1, GND3, GPI, GPO, PGND, VBAT, VDD, VDDIN, VDDM, VDDP, VPD, X+, X-, Y+, Y-	16	Test points
J1	1	4-position SMD connector FCI SFW4R-1STE1LF
J2	1	21-position SMD male connector Hirose DF9-21P-1V(32)
J3	1	4-position SMD connector, gold Hirose FH19C-4S-0.5SH(25)

DESIGNATION	QTY	DESCRIPTION
J4	0	Not installed, header
J5, J6, J7	3	2-pin headers
J8	1	SMT connector with through hole Molex 39-53-2044
J9–J12	4	3-pin headers
LED1	1	Red LED (0603) Lite-On LTST-C190CKT
R1–R5, R7, R8, R9, R17, R18, R19	11	0 $\Omega$ resistors (0603)
R6	1	215 $\Omega$ $\pm$ 1% resistor (0603)
R10	1	100k $\Omega$ $\pm$ 1% resistor (0603)
R11, R12, R13, R15	0	Not installed, resistors
R16	1	5.11k $\Omega$ $\pm$ 1% resistor (0603)
R20	1	32.4 $\Omega$ $\pm$ 1% resistor (0603)
U1	1	Touch-screen controller (20 TQFN-EP*) Maxim MAX11811ETP+
U2	1	SMD proximity sensor, IR Avago Tech HSDL-9100-021
U3	1	Photo sensor Agilent APDS-9002
—	2	Shunts (J9, J10) Sullins STC02SYAN

\*EP = Exposed pad.

## Vendor Specifications

### Motor Vendor and Specifications

Source: AAC Acoustic Technology (www.aacacoustic.com) (see Table 1).

### Touch-Panel Vendor and Specification

Densitron and Fujitsu are approved panel vendors for resistive touch-screen controllers from Maxim (see Tables 2 and 3 for recommended touch panels).

Table 1. AAC LRA Motor Specification

<b>Part Number</b>	ELV-10ES
<b>Weight</b>	2.5g (nominal)
<b>Rated Voltage</b>	1.41VRMS
<b>Nominal Operating Current</b>	60mA max
<b>Maximum Input Voltage</b>	1.875VRMS
<b>Operating Temperature Range</b>	-20°C to +70°C
<b>Storage Temperature Range</b>	-40°C to +80°C

# MAX11811 Touch Evaluation System (TEVS)

**Table 2. Densitron 4-Wire Resistive Touch-Panel Specification**

Part Number	DTS408-0380-00	DTS408-0280-00
Screen Diagonal	3.8in	2.8in
Dimension (W x H x D)	91mm x 72mm x 0.95mm	70mm x 55mm x 1.4 mm
Viewing Area	81mm x 63mm	59.6mm x 46.1mm
Active Area Width (mm)	79mm	58mm
Active Area Height (mm)	58mm	44mm
Package Mode	Film glass	
Transparency	80%	

**Table 3. Fujitsu 4-Wire Resistive Touch-Panel Specification**

Part Number	T010-1401-T670
Outer Dimension	61.4mm x 80.3mm
Transparent Area	54.4mm x 71.2mm
Active Area	51.4mm x 68.2mm
Flex Tail	30mm
Glass Thickness	0.7mm
PET Film Features	Clear
Transparency	80%

**Evaluates: MAX11811**

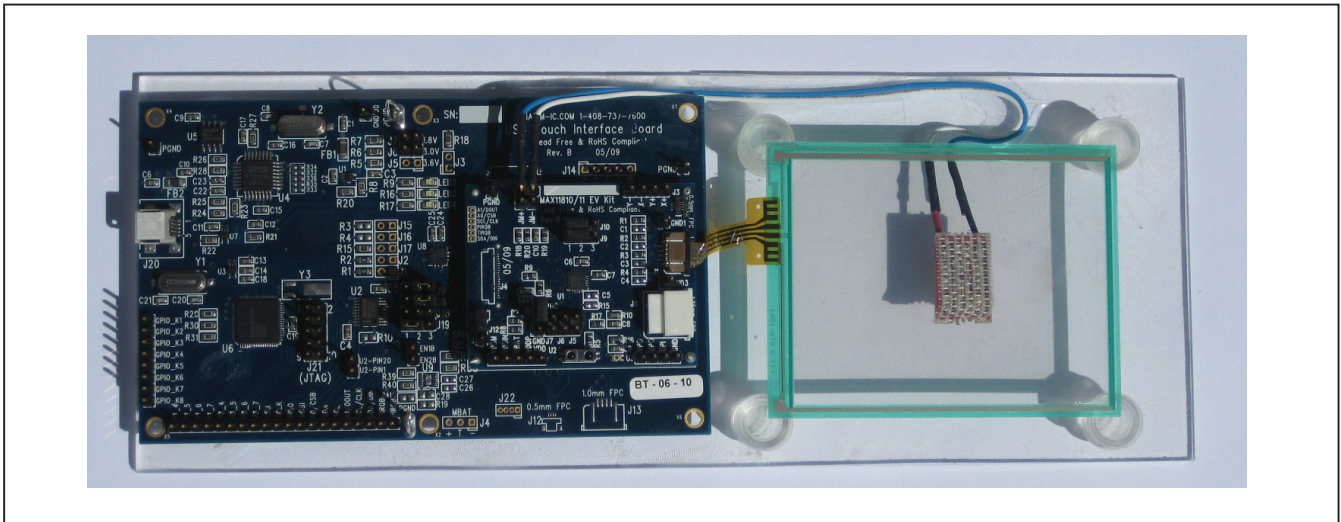

Figure 1. Complete MAX11811 Touch Evaluation System (TEVS) Photo

# MAX11811 Touch Evaluation System (TEVS)

Evaluates: MAX11811

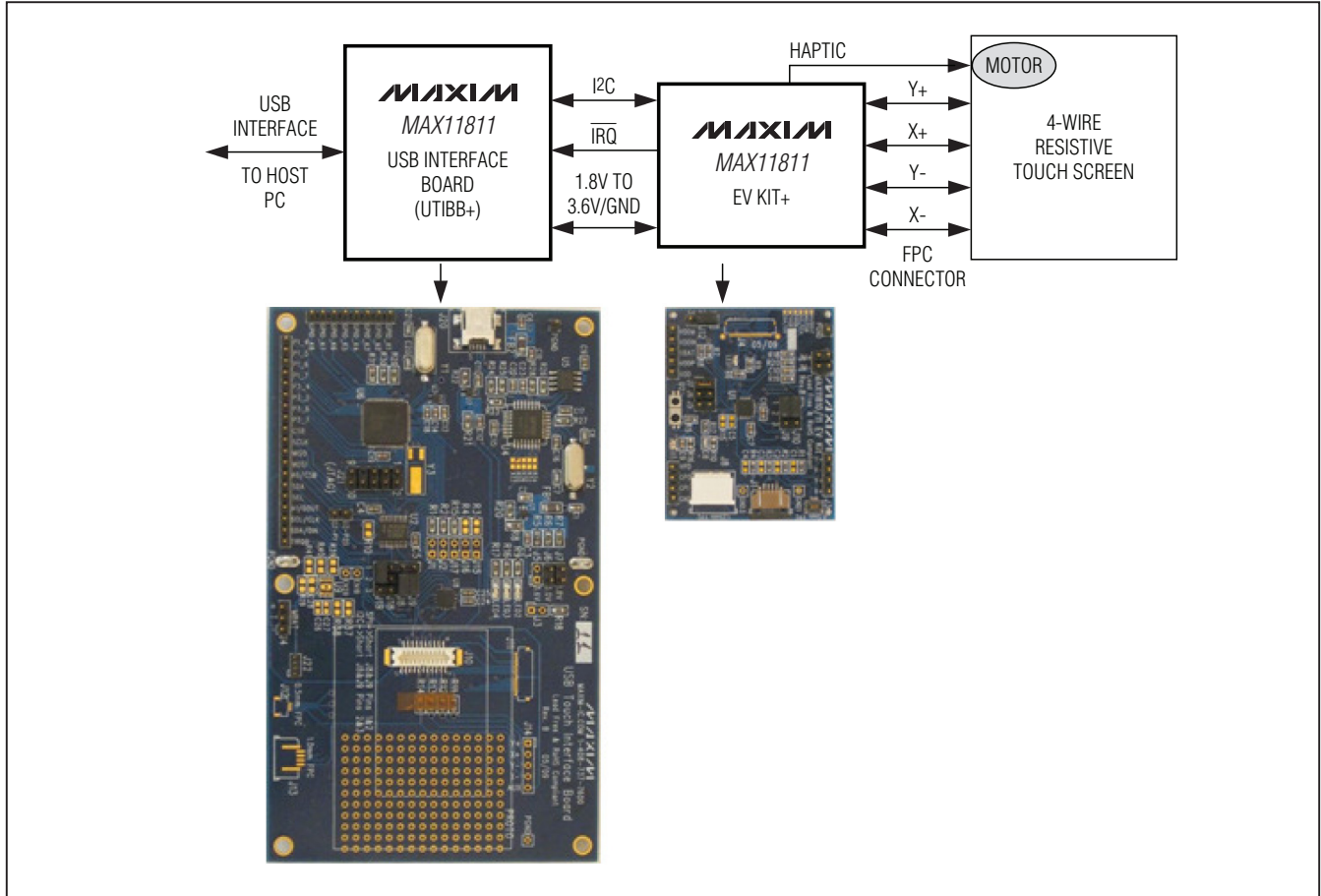

Figure 2. MAX11811 Touch Evaluation System (TEVS) Block Diagram

## Quick Start

**Note:** In the following sections, software-related items are identified by bolding. Text in **bold** refers to items directly from the EV kit software. Text in **bold and underlined** refers to items from the Windows operating system.

### Procedure (TEVS Software and USB Driver Installation)

- 1) Before plugging the TEVS into an available port on a Windows XP or Windows 7 PC, the TEVS software must be installed.
- 2) Ensure that the jumpers on the UTIBB+ board are in the following positions:
  - J8: 2-3
  - J9: 2-3
  - J19: 1-2
- 3) The software comes with the USB driver and a GUI application. Unzip the files and save the contents in an easily accessible location.
- 4) Locate the Setup.exe file and double-click on it, then follow the instructions for installation.
- 5) The driver for the EV kit is installed in the following location:
  - C:\MAXIM TSC USB DRIVER CDM20602
- 6) The application along with its supporting files is located at:
  - C:\Program Files\Maxim Integrated Products\MAX118xx EVS <version>
- 7) A shortcut to the application executable file is created on the desktop and in the **Start | Programs** menu.
- 8) To uninstall the software, go to **My Computer | Add or Remove** program.

# MAX11811 Touch Evaluation System (TEVS)

## Detailed Description of Hardware

Ensure that the MAX11811 EV kit daughter board is properly mounted on the UTIBB+ and the touch-screen panel is properly connected to the daughter board. The daughter board houses the touch-screen controller IC. This module processes the data from the touch-screen panel connected to it and streams it out to the UTIBB+ interface board.

The UTIBB+ acts as an intermediary gateway that converts the I2C (signal levels and protocol) into the USB for processing by the PC. The UTIBB+ includes a MAXQ2000 microcontroller to carry out this task.

## Hardware Installation

**Note:** Install the software before starting this step. Connect the TEVS to the PC using the USB cable provided. A dialog box appears, as shown in Figure 3.

Click on the **Install from a list or specific location (Advanced)** radio button and then press the **Next >** button.

Type **C:\MAXIM TSC USB DRIVER CDM20602** in the edit box, as shown in Figure 4, or press the **Browse** button to find the CMAXQUSB driver folder. Press the **Next >** button to proceed.

During the installation steps, a **Hardware Installation** warning message is displayed, as shown in Figure 5. Press the **Continue Anyway** button to proceed.

Follow all the steps that come up next and exit when done. At the end of the process, the driver is installed and the device is ready to be used. Disconnect and plug the device back in again.



Figure 3. Found New Hardware Wizard Dialog

# MAX11811 Touch Evaluation System (TEVS)

Evaluates: MAX11811

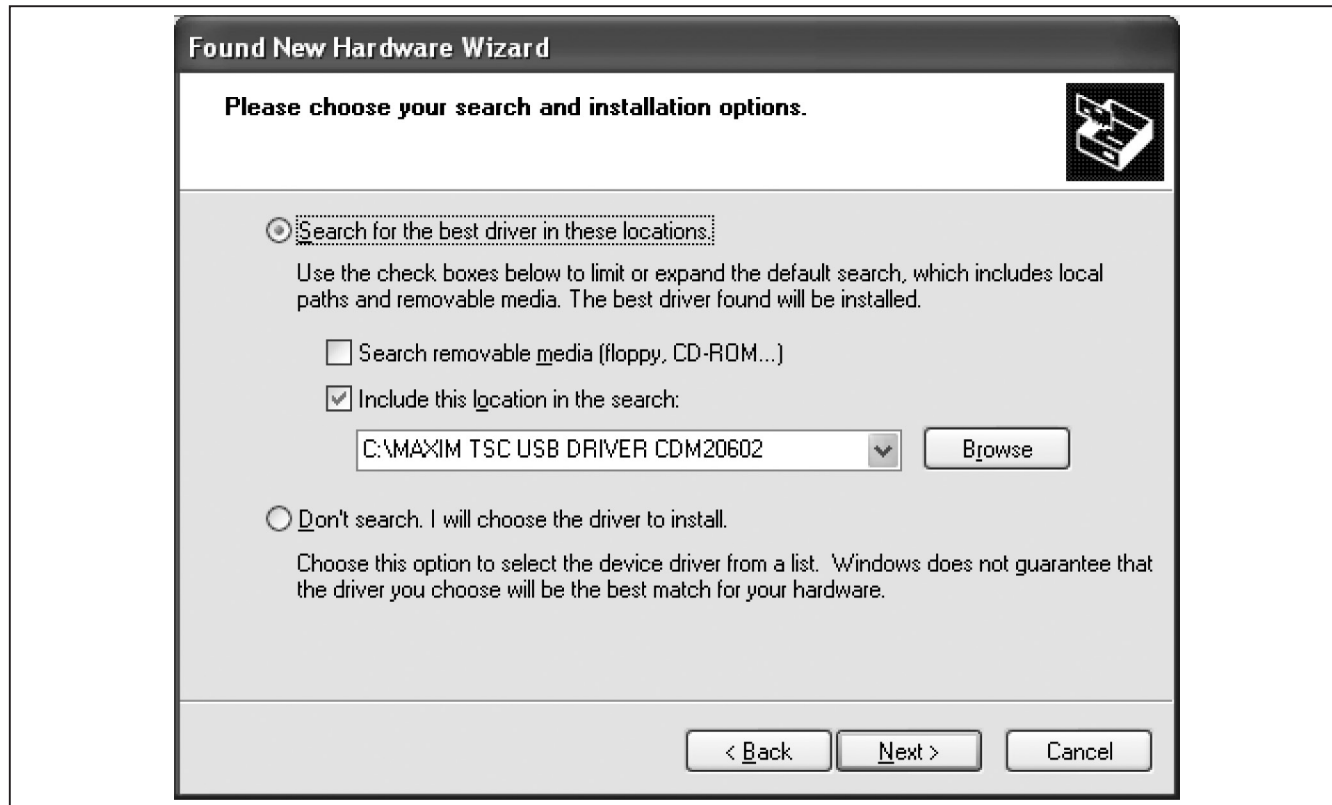

Figure 4. Search for the Best Driver



Figure 5. Windows Logo Testing Warning



# MAX11811 Touch Evaluation System (TEVS)

## MAX11811 TEVS GUI Description

After successful installation of the driver, connect the TEVS to the PC using the USB cable. Start the GUI by double-clicking on the MAX118xxEVS <version>.exe file. Following a successful communication link, the GUI indicates what it has found at two locations on the GUI:

- 1) The window caption:

**MAX11811 4-wire Advanced Touch Screen Controller**

- 2) The status bar:

**TSC Communication: I2C TSC device found**

**I2C Addr. = 0x96**

**USB comm. successful**

## Registers Tab

The **Registers** tab shown in Figure 6 displays a successful communication link with a TSC device. This tab displays the registers related to X, Y, Z1, and Z2 measurement of the device. The user can manipulate the register values by changing the binary bit patterns on the right or the hex values on the left. Refer to the MAX11811 IC data sheet for details on the registers.

Upon startup, factory-default values of the TSC registers from the MAX11810-11\_init.ini files are loaded onto the GUI and then written into the TSC.

The user can change the factory-default values in the MAX11810-11\_init.ini file, with new values entered by the user on the GUI by selecting the **File | Save** option from the menu bar. This overwrites the factory-default values in the MAX11810-11\_init.ini file. The user also has the option to save the register values on the GUI screen under a different name by selecting the **File | Save As** option, and to open and load a previously saved file by selecting the **File | Open and Load** option.

The GUI automatically writes to the TSC when a new .ini file is opened and loaded. However, when the user individually manipulates bits on the GUI screen, it must be followed by pressing the **Write Registers** button. The **Read Registers** button reads all the registers from the TSC and displays it in the binary and hex fields.

At any time, the computer mouse can be scrolled over a checkbox (the bit indicators) and the status with a description of the bit is indicated by the tool tip.

**Note:** Any changes on the GUI must be followed by a press of the **Write Registers** button for the value to be loaded into the TSC.

## Haptic Registers Tab

The **Haptic Registers** tab holds registers for configuring the haptic patterns (refer to the MAX11811 IC data sheet for details on the registers). The user can manipulate the values through the drop-down combo boxes and the various checkboxes.

As in the **Registers** tab, the factory-default values from the MAX11810-11\_init.ini files are loaded onto the GUI and then written into the TSC at startup.

The quickest way to test the haptic patterns is to use the preprogrammed set of values given in the drop-down combo boxes. The drop-down combo box in green is for the linear resonant actuator (LRA) motor and the drop-down combo box in yellow is for the eccentric rotating mass (ERM) motor (see Figure 7).

The user also has the ability to **Enable Haptics** (checkbox) and **Generate Haptic** (button). A delay can also be entered in milliseconds for the haptic to be generated through the **Haptic Delay** edit box.

Any manual changes made to the registers should be followed by pressing the **Write Registers** button for the value to be sent to the TSC.

As in the **Registers** tab, the user can change the factory-default values in the MAX11810-11\_init.ini file, with new values entered on the GUI using the **File | Save** option from the menu bar. This overwrites the factory-default values in the MAX11810-11\_init.ini file. The user also has the option to save the register values on the GUI screen under a different name using the **File | Save As** option, and to open and load a previously saved file by using the **File | Open and Load** option.

## Touch Data Tab

The **Touch Data** tab displays the user inputs on the touch panel on a screen. The user can make various selections to display a combination of X, Y, Z1, and Z2 data along with their processed/mathematical interpretation.

As in the **Haptic Registers** tab, the user can **Enable Haptics** (checkbox) and also apply a delay in milliseconds through the **Haptic Delay** edit box. The drop-down combo box with preprogrammed haptic patterns is also available in this tab for both the LRA and ERM motor.

The TSC has two modes of operation, direct and autonomous. Refer to the MAX11811 IC data sheet for more details.

**Direct Mode:** Direct mode can be selected in the **Registers** tab by selecting it in the **Operating Mode**

# MAX11811 Touch Evaluation System (TEVS)

Evaluates: MAX11811

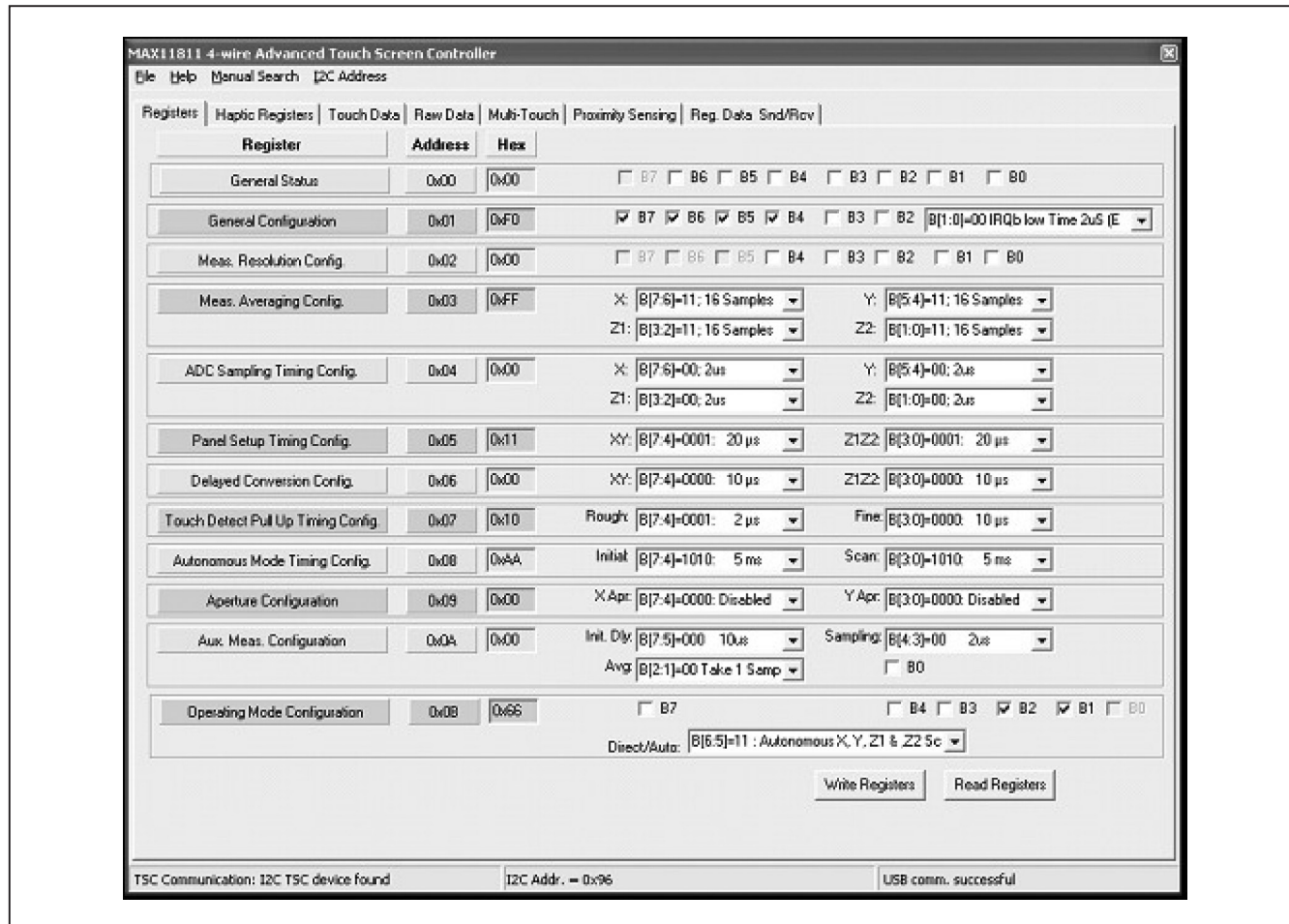

Figure 6. Registers Tab

# MAX11811 Touch Evaluation System (TEVS)

Evaluates: MAX11811

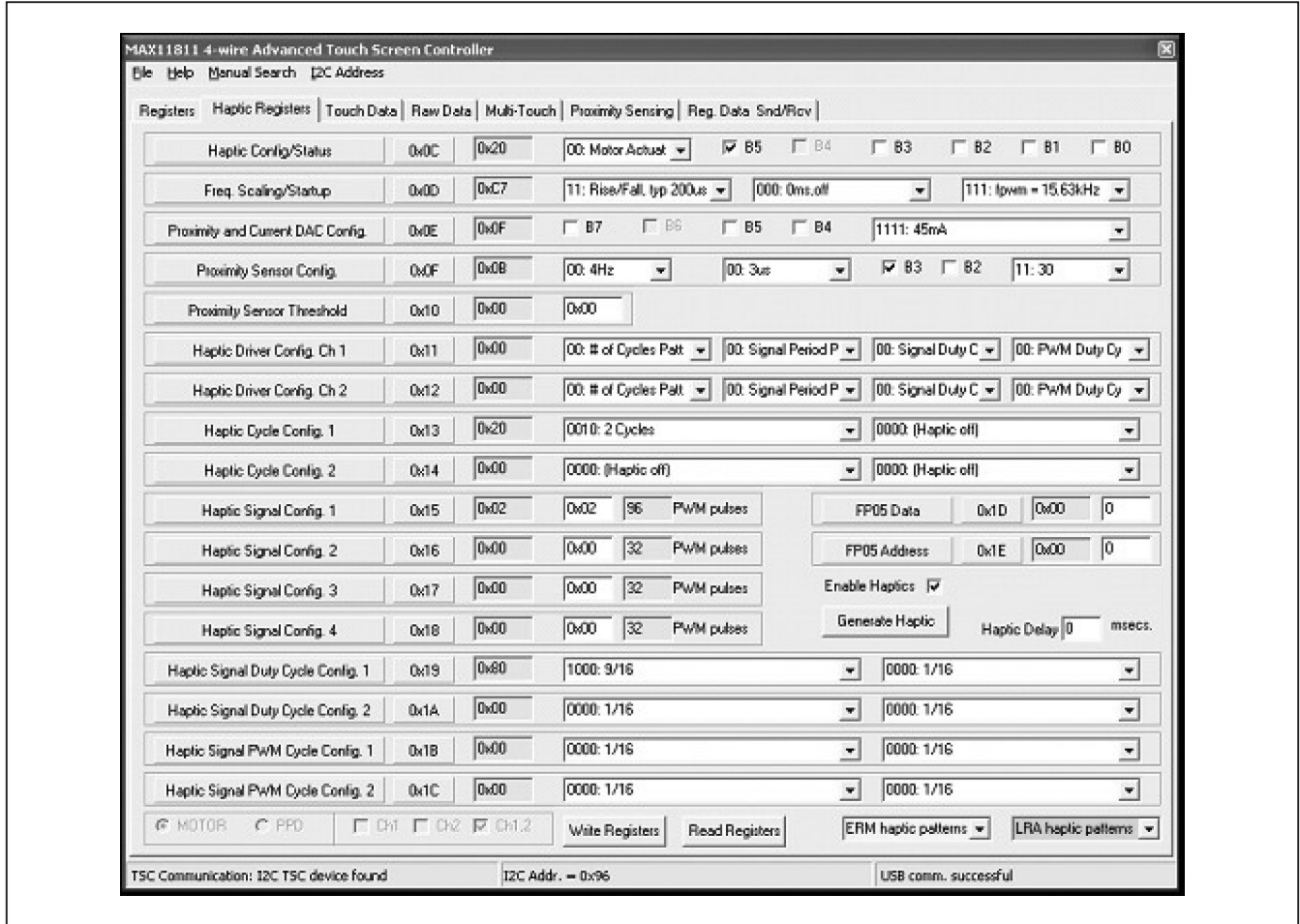

Figure 7. Haptic Registers Tab

# MAX11811 Touch Evaluation System (TEVS)

**Configuration** register, or by selecting it in the **Touch Data** tab, as shown in Figure 8.

**Autonomous Mode:** Autonomous mode can be selected in the **Registers** tab by selecting it in the **Operating Mode Configuration** register, or by selecting it in the **Touch Data** tab, as shown in Figure 9.

### **Raw Data**

The **Raw Data** tab (Figure 10) displays a stream of raw data collected during the operation of the TSC. This data can be saved for data analysis by pressing the **Save Data** button.

### **Multi-Touch Tab**

The **Multi-Touch** tab (Figures 11, 12, and 13) gives a simple demo of the multi-touch on a resistive panel. Use the touch panel to enlarge and reduce the picture found in this tab. This works only in the autonomous mode. Contact the factory for details on this feature.

### **Proximity Sensing Tab**

The GUI currently does not support this feature. However, this feature is available in the TEVS hardware and the

TSC chip fully supports this feature, as described in the MAX11811 IC data sheet.

### **Reg. Data Snd/Rcv Tab**

The **Reg. Data Snd/Rcv** tab lets the user send and receive multiple data to the TSC registers.

Figure 14 shows an example where the first line is writing 0xF1 to register 0x01 (the **Activate** checkbox must be checked). The second line reads register 0x01 with what was written in the first line.

The **TSC + Eval. Sys. Response (Hex)** box shown in Figure 14 displays the whole protocol and may be of interest while debugging only. The **4F 4B 00** is the response from the TEVS following a successful write and is the ASCII OK, **5A 00 01 F1** is the response from the TEVS for a request read, **5A** is a sync byte, **00** is reserved, **01** indicates that 1 byte of data is to follow, and **F1** is the (1 byte) data.

The **TSC Response ONLY (Hex)** box displays the TSC response only. Since the only relevant information is the register data, it displays **F1** (the content of register 0x01).

# MAX11811 Touch Evaluation System (TEVS)

Evaluates: MAX11811

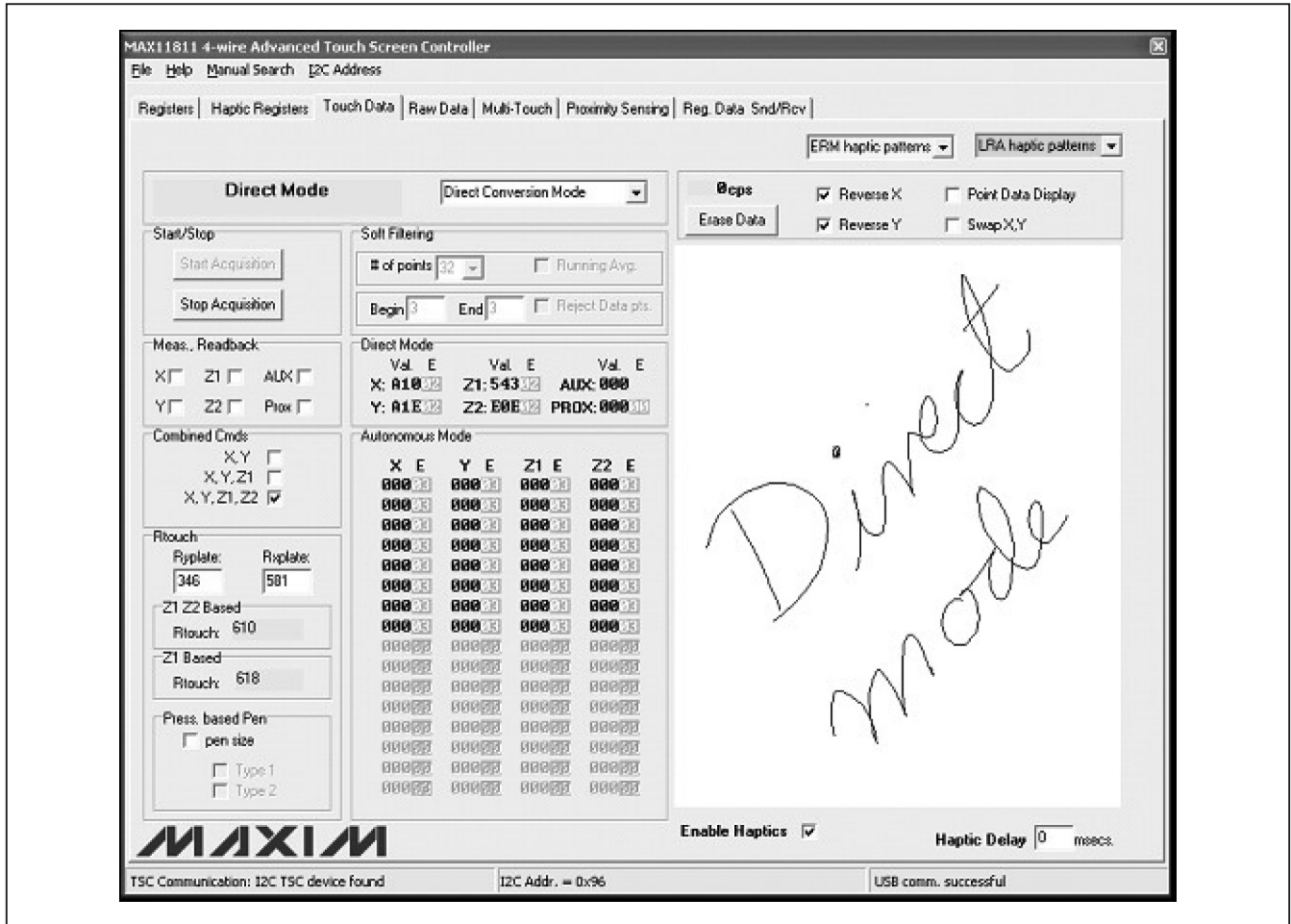

Figure 8. Touch Data Tab (Direct Mode)



# MAX11811 Touch Evaluation System (TEVS)

Evaluates: MAX11811

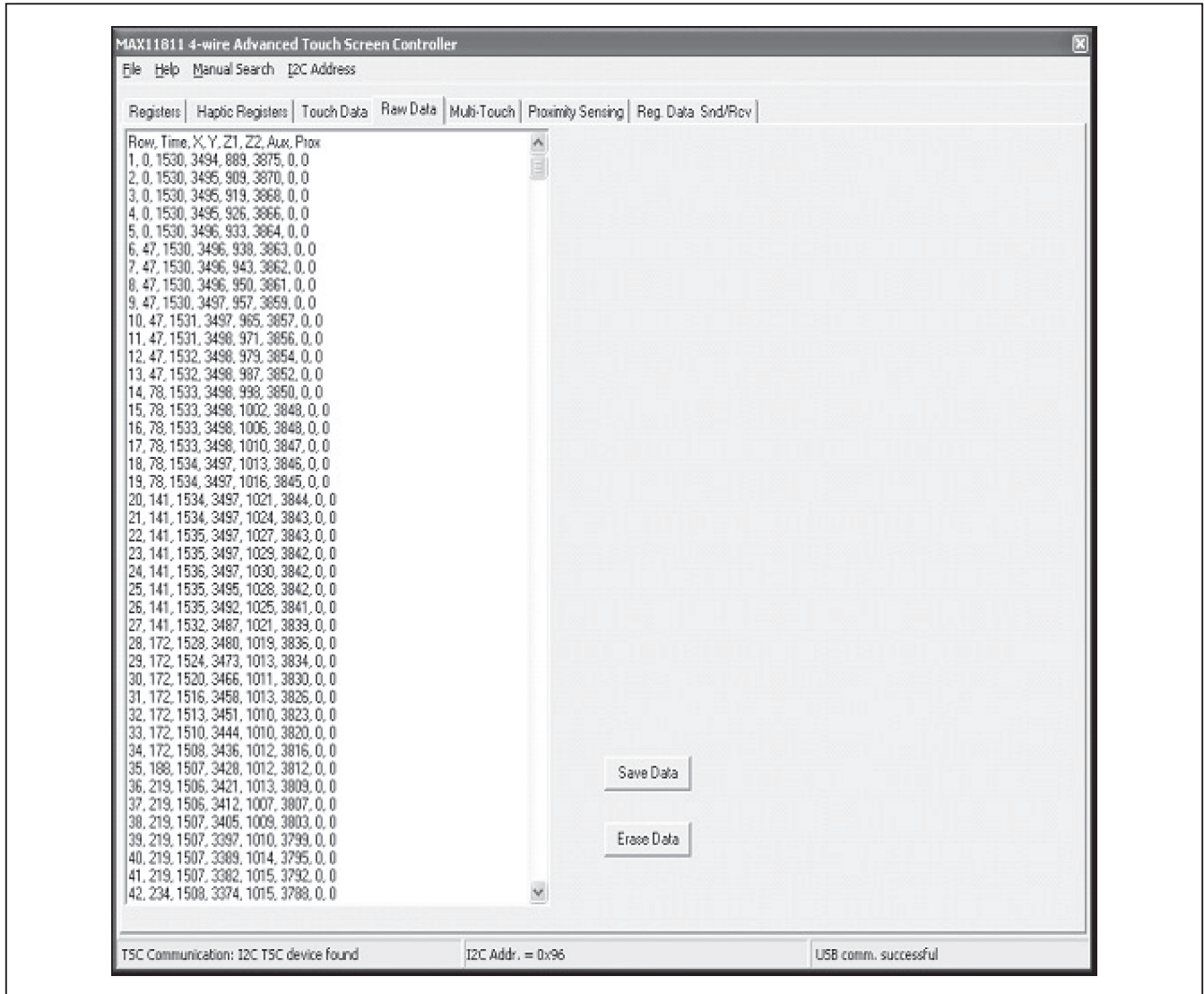

Figure 10. Raw Data Tab

# MAX11811 Touch Evaluation System (TEVS)

Evaluates: MAX11811

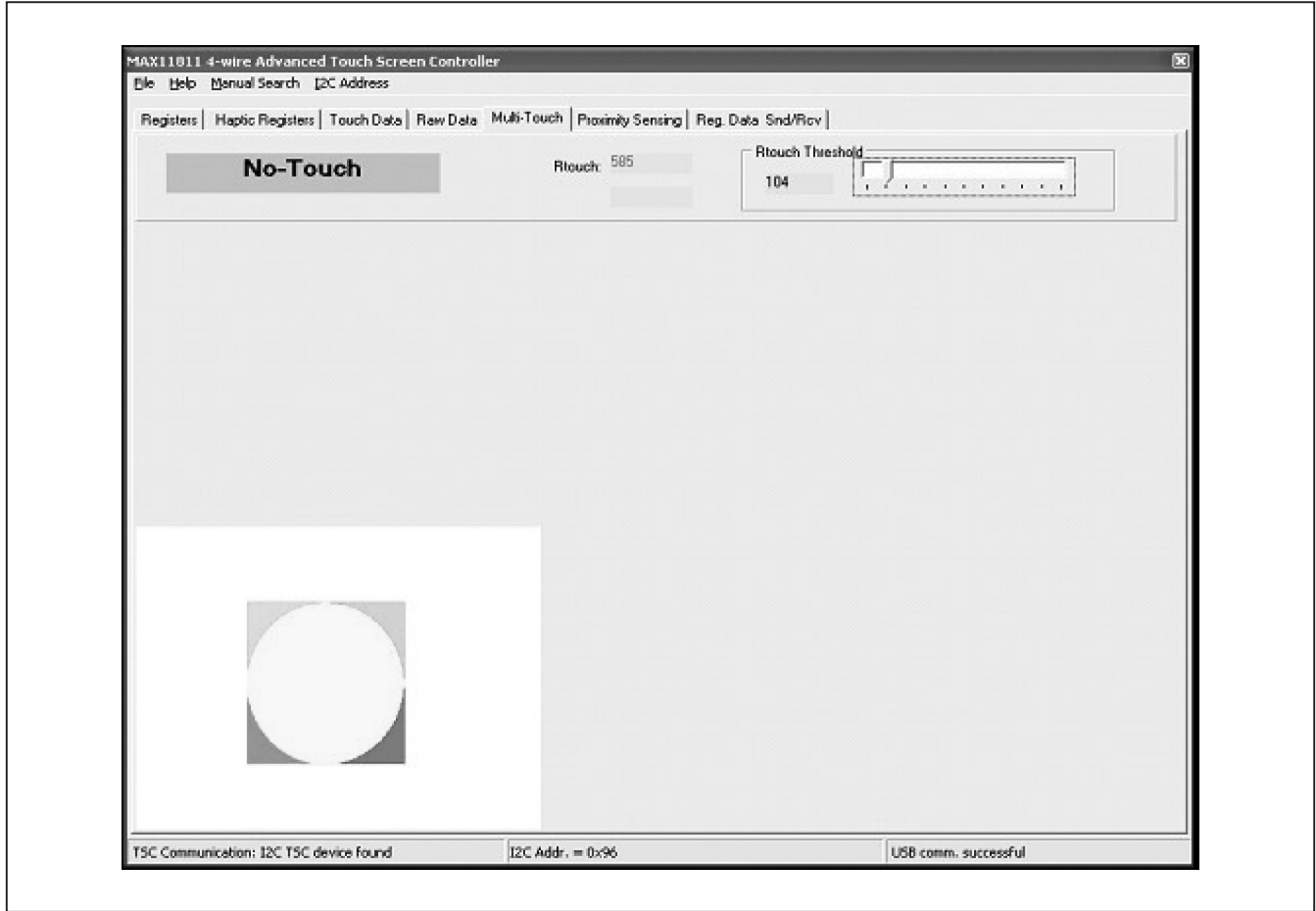

Figure 11. Multi-Touch Tab (Before Zoom Out and Rotate)



# MAX11811 Touch Evaluation System (TEVS)

Evaluates: MAX11811

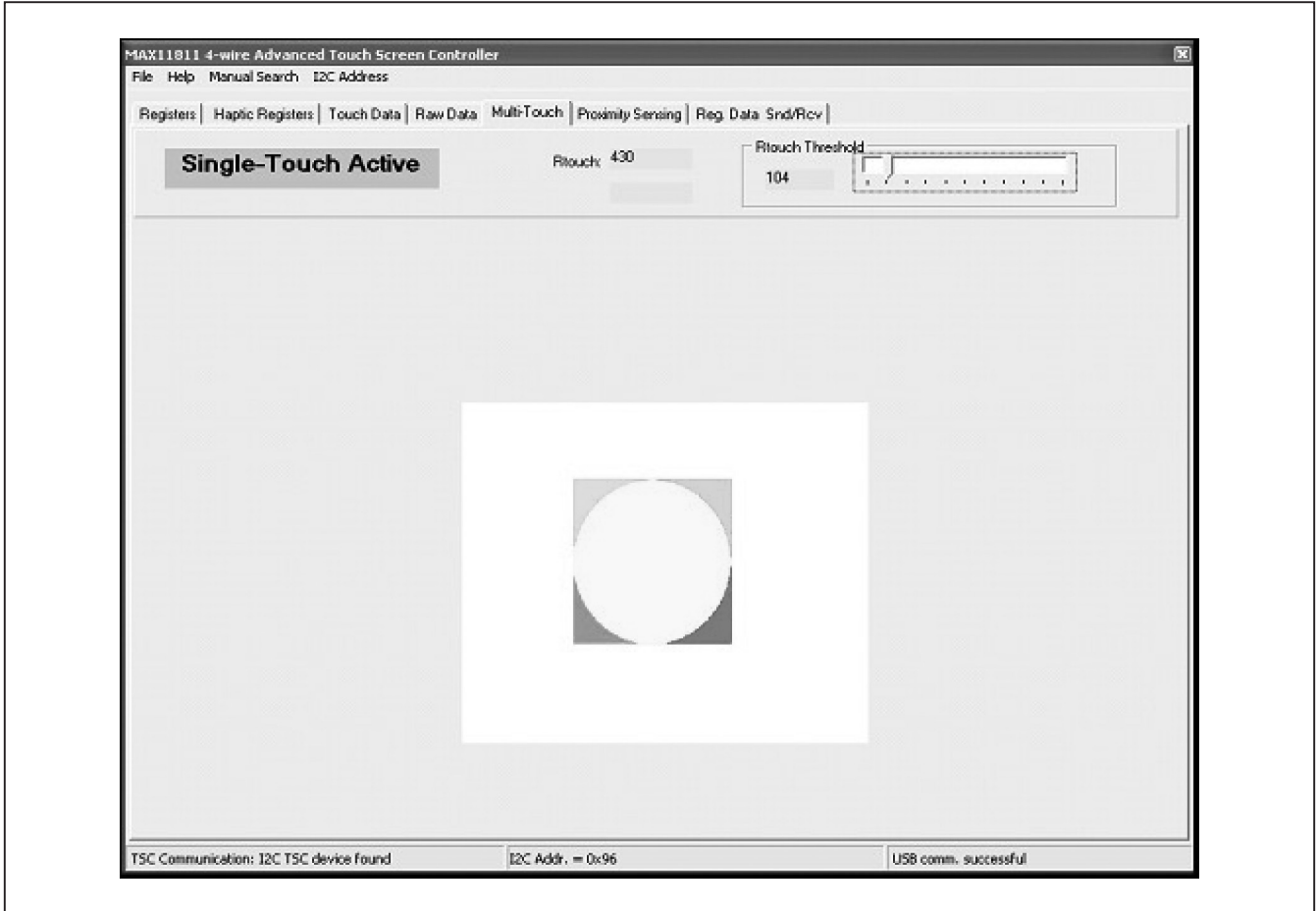

Figure 12. Multi-Touch Tab (Single-Touch Active)

# MAX11811 Touch Evaluation System (TEVS)

Evaluates: MAX11811

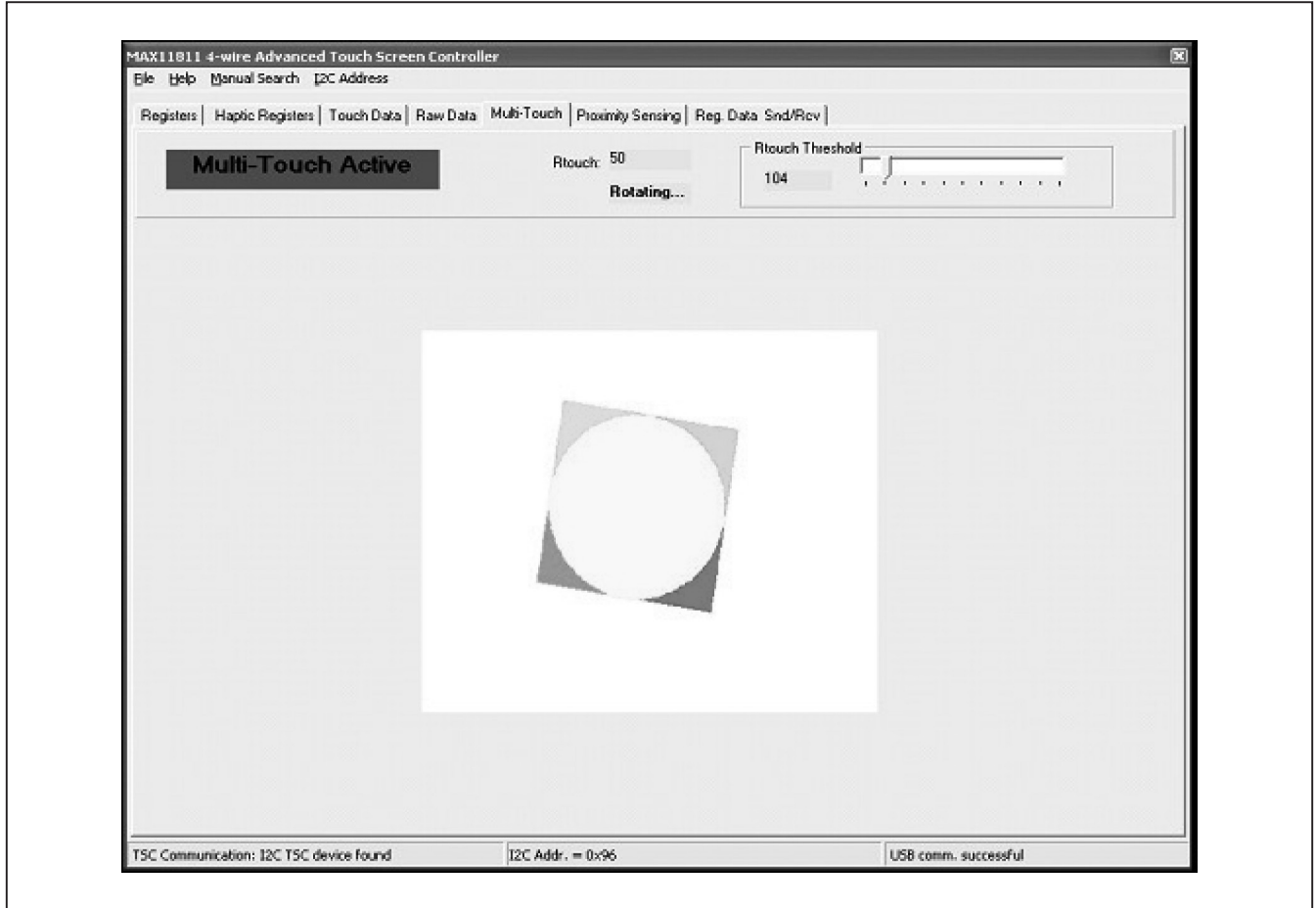

Figure 13. Multi-Touch Tab (After Zoom Out and Rotate During the Multi-Touch Mode)

# MAX11811 Touch Evaluation System (TEVS)

Evaluates: MAX11811

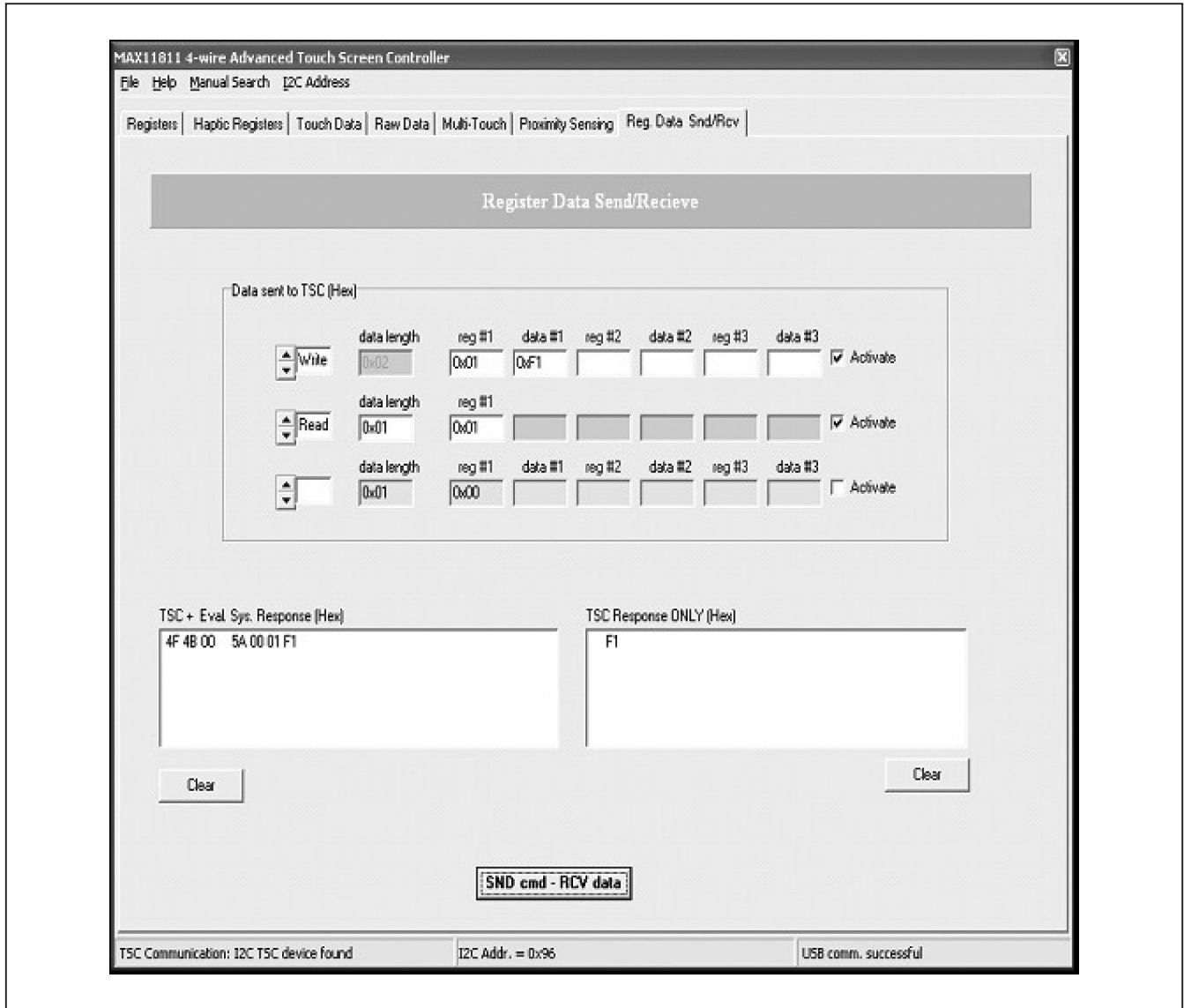

Figure 14. Reg. Data Snd/Rcv Tab

# MAX11811 Touch Evaluation System (TEVS)

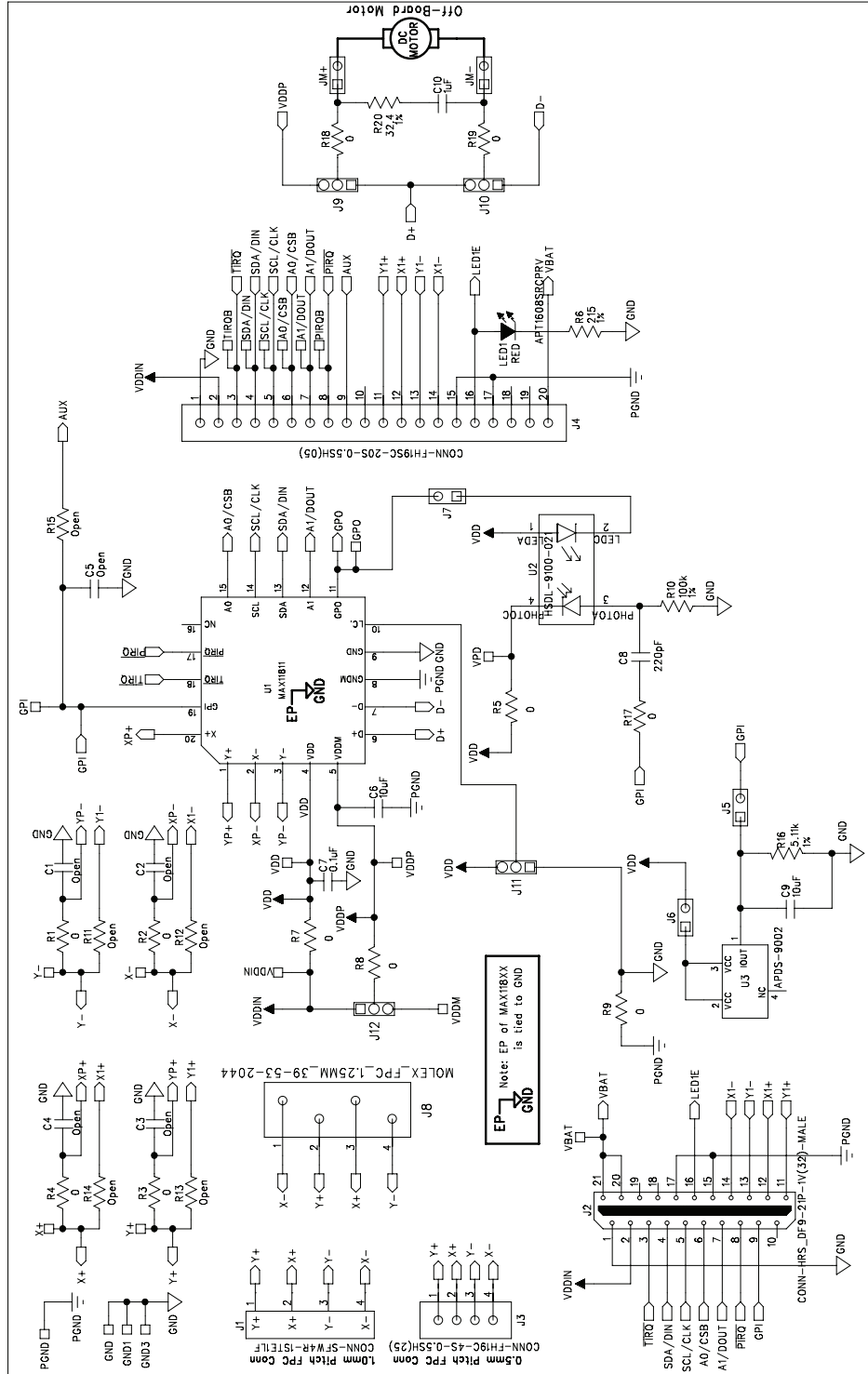

Figure 15. MAX11811 EV Kit Schematic

# MAX11811 Touch Evaluation System (TEVS)

Evaluates: MAX11811

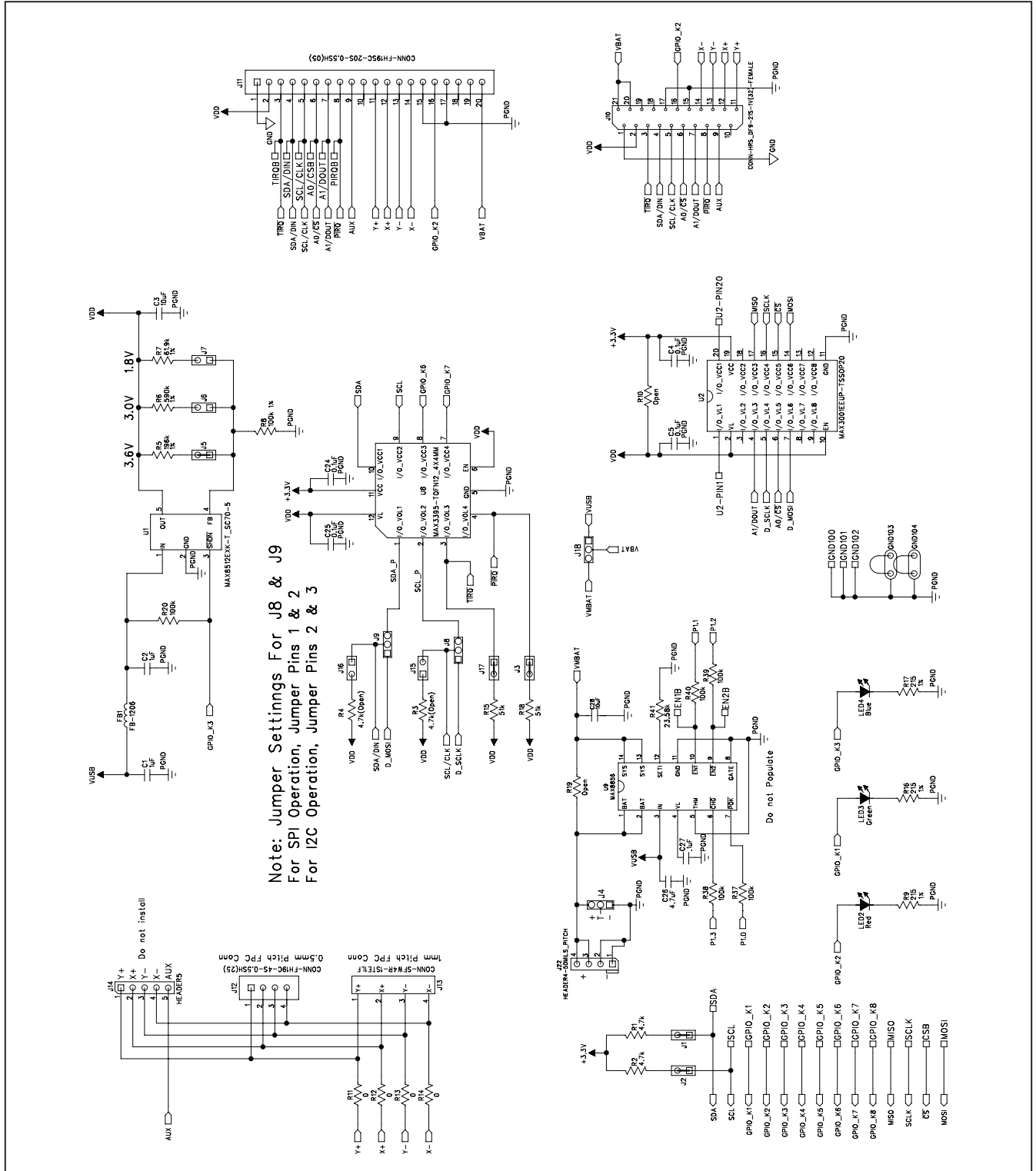

Figure 16a. MAX11811 Interface Board Schematic (Sheet 1 of 2)



# MAX11811 Touch Evaluation System (TEVS)

## Revision History

REVISION NUMBER	REVISION DATE	DESCRIPTION	PAGES CHANGED
0	9/10	Initial release	—

**Evaluates: MAX11811**

*Maxim cannot assume responsibility for use of any circuitry other than circuitry entirely embodied in a Maxim product. No circuit patent licenses are implied. Maxim reserves the right to change the circuitry and specifications without notice at any time.*

**Maxim Integrated Products, 120 San Gabriel Drive, Sunnyvale, CA 94086 408-737-7600 \_\_\_\_\_ 23**