

Thermally-Enhanced High Power RF LDMOS FET 240 W, 1450 – 1500 MHz

www.DataSheet4U.net

Description

The PTFA142401EL and PTFA142401FL are 240-watt LDMOS FETs designed for DVB and DAB applications in the 1450 to 1500 MHz frequency band. Features include internal I/O matching and thermally-enhanced packages with slotted or earless flanges. Manufactured with Infineon's advanced LDMOS process, these devices provide excellent thermal performance and superior reliability.

PTFA142401EL
 Package H-33288-2

PTFA142401FL
 Package H-34288-2

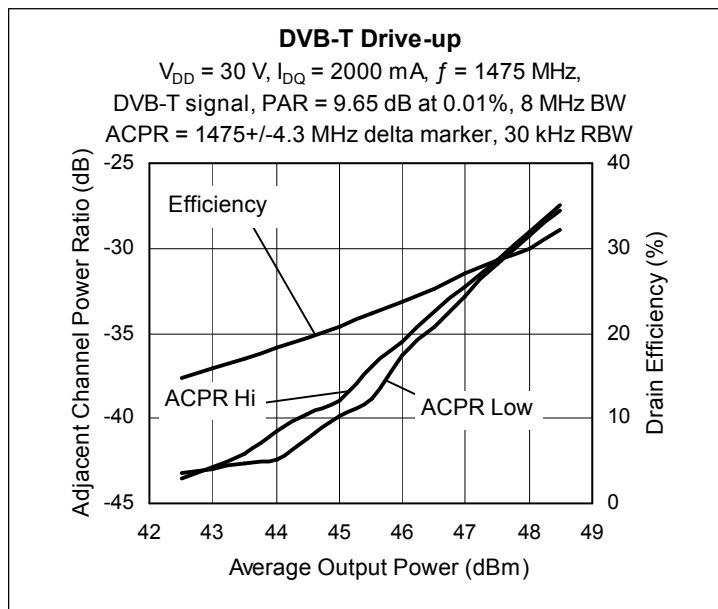

Features

- Pb-free, RoHS-compliant and thermally-enhanced packages with less than 0.25 micron Au plating
- Broadband internal matching
- Typical DVB-T performance at 1475 MHz, 30 V
 - Average output power = 47.0 dBm
 - Linear Gain = 16.0 dB
 - Efficiency = 27.5%
 - Adjacent channel power = -32 dBc
- Typical CW performance, 1475 MHz, 30 V
 - Output power at P-1dB = 240 W
 - Efficiency = 52%
- Integrated ESD protection: Human Body Model, Class 2 (minimum)
- Excellent thermal stability, low HCI drift
- Capable of handling 10:1 VSWR @ 30 V, 200 W (CW) output power

RF Characteristics

DVB-T Measurements (not subject to production test—verified by design/characterization in Infineon test fixture)

$V_{DD} = 30\text{ V}$, $I_{DQ} = 2.0\text{ A}$, $P_{OUT} = 50\text{ W}$ average

$f = 1475\text{ MHz}$ DVB-T, channel bandwidth = 8.0 MHz, peak/average = 9.65 dB @ 0.01% CCDF

Characteristic	Symbol	Min	Typ	Max	Unit
Gain	G_{ps}	—	16.5	—	dB
Drain Efficiency	η_D	—	27.5	—	%
Adjacent Channel Power Ratio ($\pm 4.3\text{ MHz}$ offset, 30 kHz RBW)	ACPR	—	-32	—	dBc

All published data at $T_{CASE} = 25^\circ\text{C}$ unless otherwise indicated

ESD: Electrostatic discharge sensitive device—observe handling precautions!

RF Characteristics (cont.)

Two-tone Measurements (tested in Infineon test fixture)

$V_{DD} = 30\text{ V}$, $I_{DQ} = 2.0\text{ A}$, $P_{OUT} = 240\text{ W PEP}$, $f = 1500\text{ MHz}$, tone spacing = 1 MHz

Characteristic	Symbol	Min	Typ	Max	Unit
Gain	G_{ps}	15.0	16.0	—	dB
Drain Efficiency	η_D	40	43	—	%
Intermodulation Distortion	IMD	—	-31	-29	dBc

DC Characteristics

Characteristic	Conditions	Symbol	Min	Typ	Max	Unit
Drain-Source Breakdown Voltage	$V_{GS} = 0\text{ V}$, $I_{DS} = 10\text{ mA}$	$V_{(BR)DSS}$	65	—	—	V
Drain Leakage Current	$V_{DS} = 28\text{ V}$, $V_{GS} = 0\text{ V}$	I_{DSS}	—	—	1.0	μA
Drain Leakage Current	$V_{DS} = 63\text{ V}$, $V_{GS} = 0\text{ V}$	I_{DSS}	—	—	10.0	μA
On-State Resistance	$V_{GS} = 10\text{ V}$, $V_{DS} = 0.1\text{ V}$	$R_{DS(on)}$	—	0.05	—	Ω
Operating Gate Voltage	$V_{DS} = 30\text{ V}$, $I_{DQ} = 2.0\text{ A}$	V_{GS}	2.0	2.5	3.0	V
Gate Leakage Current	$V_{GS} = 10\text{ V}$, $V_{DS} = 0\text{ V}$	I_{GSS}	—	—	1.0	μA

Maximum Ratings

Parameter	Symbol	Value	Unit
Drain-Source Voltage	V_{DSS}	65	V
Gate-Source Voltage	V_{GS}	-0.5 to +12	V
Junction Temperature	T_J	200	$^{\circ}\text{C}$
Total Device Dissipation	P_D	625	W
Above 25 $^{\circ}\text{C}$ derate by		3.57	W/ $^{\circ}\text{C}$
Storage Temperature Range	T_{STG}	-40 to +150	$^{\circ}\text{C}$
Thermal Resistance ($T_{CASE} = 70^{\circ}\text{C}$, 240 W CW)	$R_{\theta JC}$	0.28	$^{\circ}\text{C}/\text{W}$

Ordering Information

Type and Version	Package Outline	Package Description	Shipping	Marking
PTFA142401EL V4	H-33288-2	Thermally-enhanced, slotted flange, single-ended	Tray	PTFA142401EL
PTFA142401FL V4	H-34288-2	Thermally-enhanced, earless flange, single-ended	Tray	PTFA142401FL

Typical Performance (data taken in an Infineon test fixture)

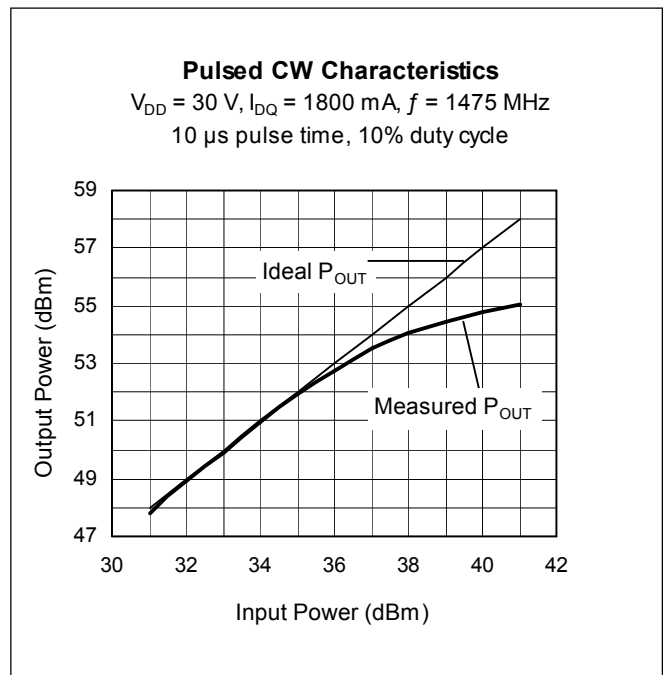
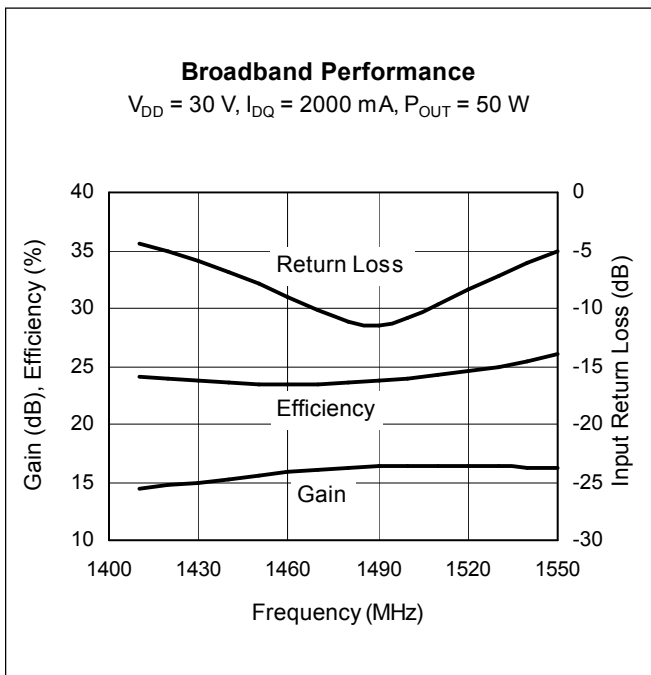
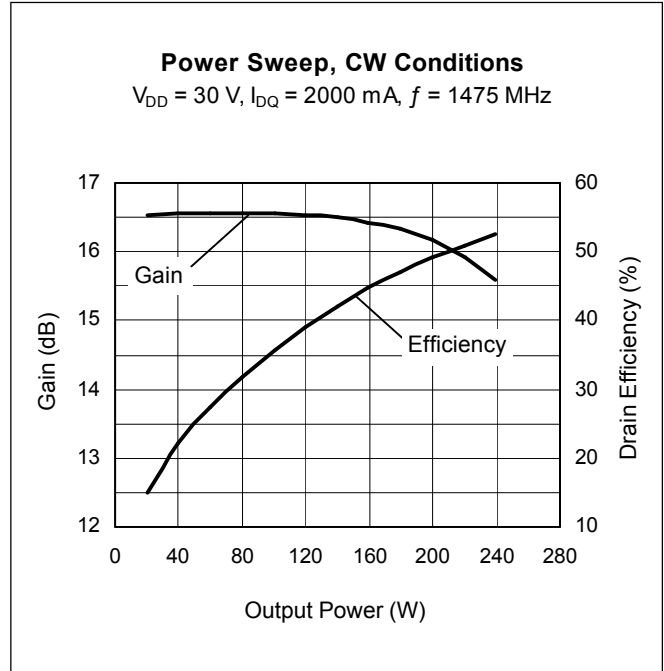
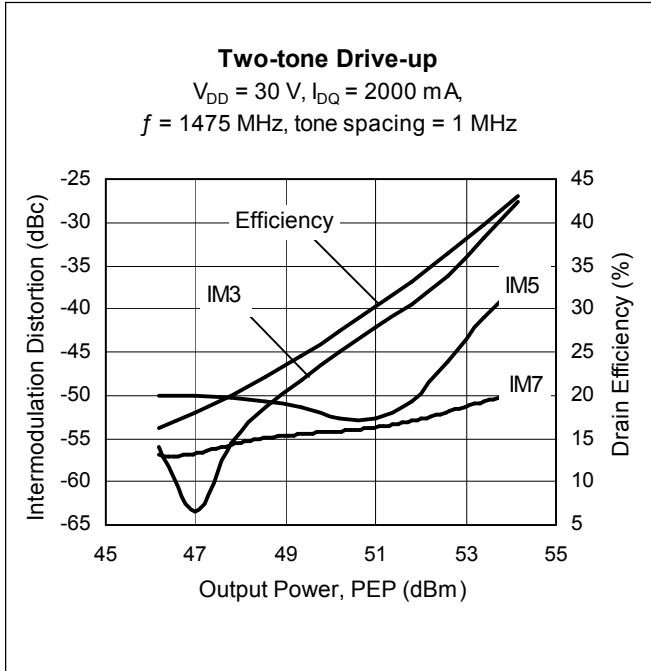

Typical Performance (cont.)

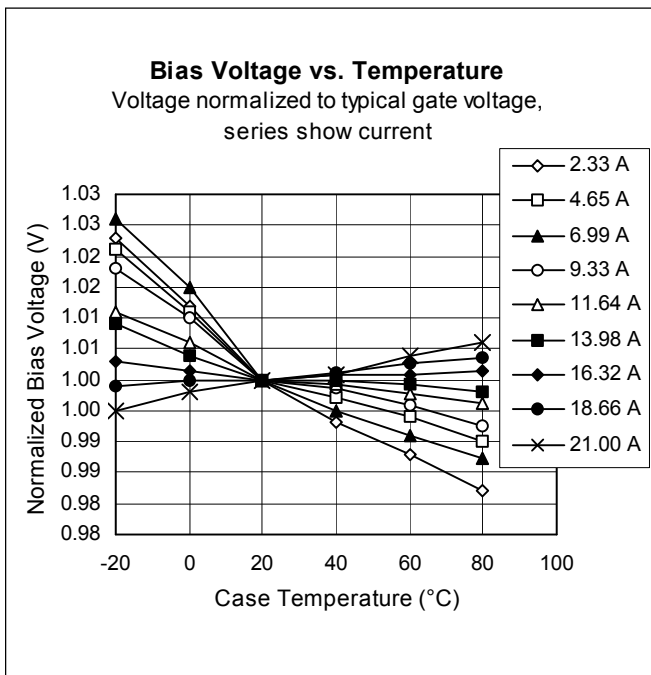
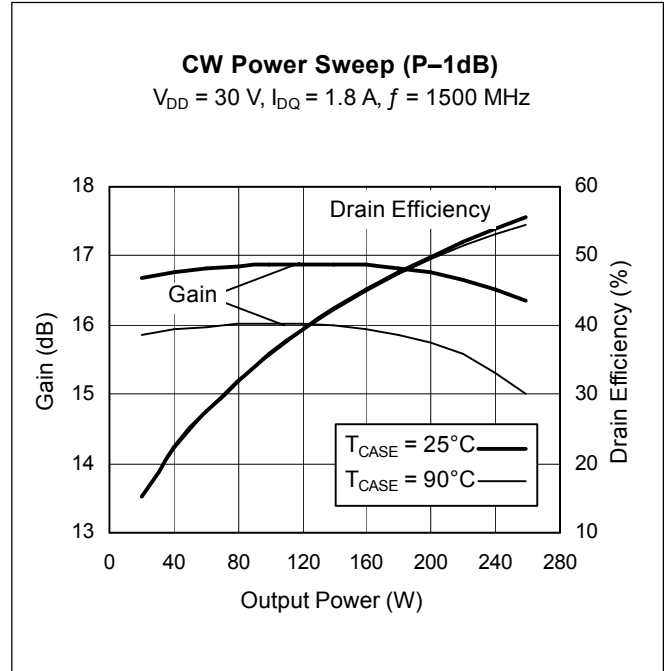
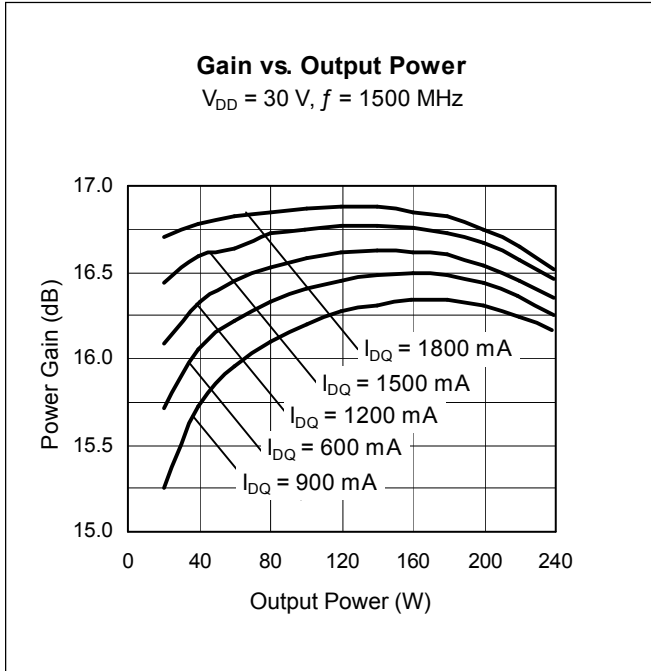

Broadband Circuit Impedance

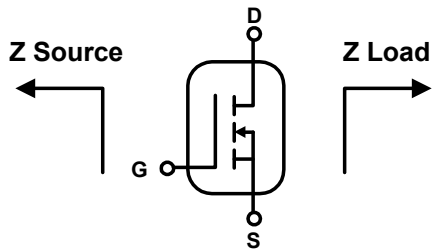

Frequency	Z Source W		Z Load W	
	R	jX	R	jX
1450	2.3	-6.4	1.2	-1.4
1463	2.3	-6.2	1.2	-1.3
1475	2.2	-6.0	1.2	-1.2
1488	2.2	-5.8	1.2	-1.2
1500	2.1	-5.7	1.2	-1.1

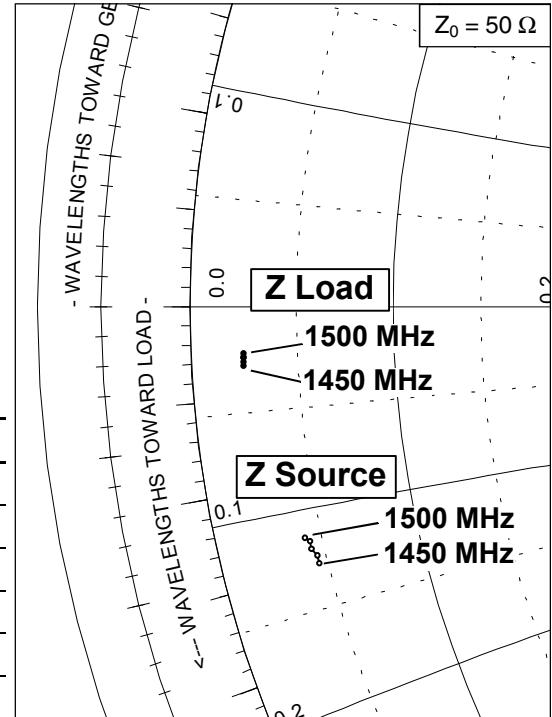

See next page for circuit information

Reference Circuit

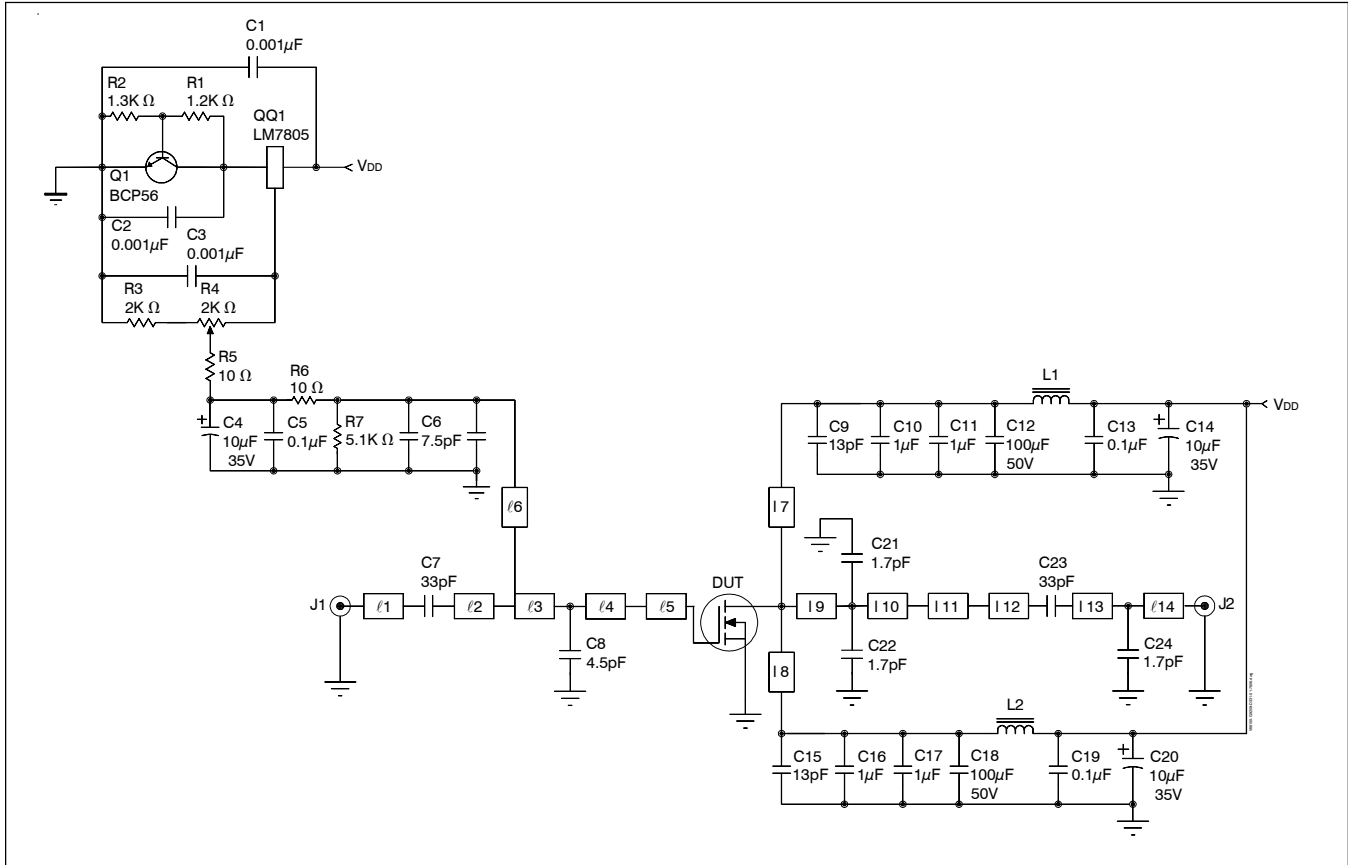

Reference circuit schematic for $f = 1475$ MHz

Circuit Assembly Information

DUT	PTFA142401EL or PTFA142401FL	LDMOS Transistor	
PCB	0.76 mm [.030"] thick, $\epsilon_r = 4.5$	TMM4	2 oz. copper

Microstrip	Electrical Characteristics at 1475 MHz	Dimensions: L x W (mm)	Dimensions: L x W (in.)
ℓ_1	0.038λ , 53.1, Ω	4.17 x 1.52	0.164 x 0.060
ℓ_2	0.108λ , 47.5, Ω	11.86 x 1.91	0.467 x 0.075
ℓ_3	0.014λ , 47.5, Ω	1.57 x 1.91	0.062 x 0.075
ℓ_4	0.012λ , 16.3, Ω	1.22 x 7.62	0.048 x 0.300
ℓ_5	0.051λ , 8.9, Ω	5.08 x 15.24	0.200 x 0.600
ℓ_6	0.171λ , 66.9, Ω	19.10 x 1.02	0.752 x 0.040
ℓ_7, ℓ_8	0.177λ , 60.0, Ω	19.66 x 1.27	0.774 x 0.050
ℓ_9	0.049λ , 5.0, Ω	4.80 x 27.94	0.189 x 1.100
ℓ_{10}	0.065λ , 5.0, Ω	6.38 x 27.94	0.251 x 1.100
ℓ_{11}	0.059λ , 10.6, Ω	5.97 x 12.70	0.235 x 0.500
ℓ_{12}	0.006λ , 53.1, Ω	0.71 x 1.52	0.028 x 0.060
ℓ_{13}	0.011λ , 53.1, Ω	1.19 x 1.52	0.047 x 0.060
ℓ_{14}	0.046λ , 53.1, Ω	5.05 x 1.52	0.199 x 0.060

Reference Circuit (cont.)

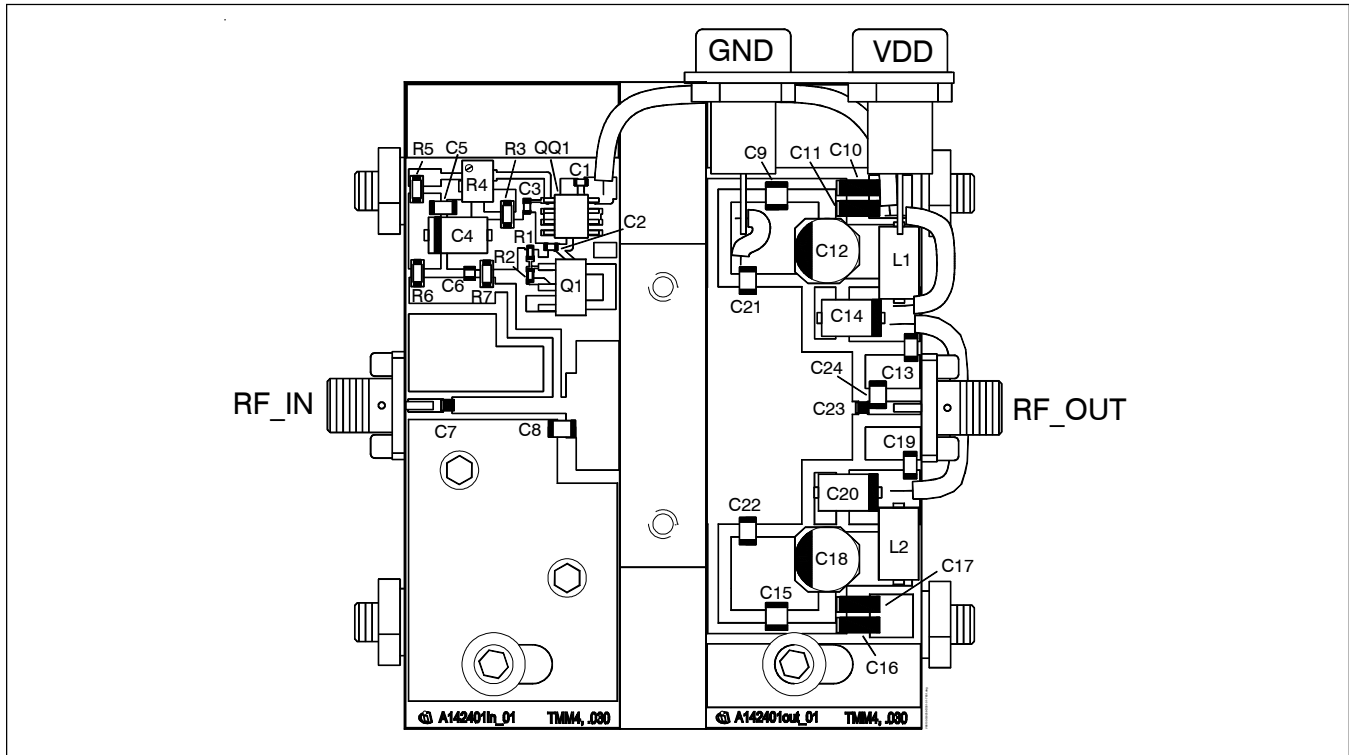

Reference circuit assembly diagram * (not to scale)

Component	Description	Suggested Manufacturer	P/N or Comment
C1, C2, C3	Capacitor, 0.001 μ F	Digi-Key	PCC1772CT-ND
C4, C14, C20	Tantalum capacitor, 10 μ F, 35 V	Digi-Key	399-1655-2-ND
C5, C13, C19	Capacitor, 0.1 μ F	Digi-Key	PCC104BCT-ND
C6	Ceramic capacitor, 7.5 pF	ATC	100B 7R5
C7, C23	Ceramic capacitor, 33 pF	ATC	100B 330
C8	Ceramic capacitor, 4.5 pF	ATC	100B 4R5
C9, C15	Ceramic capacitor, 13 pF	ATC	100B 130
C10, C11, C16, C17	Capacitor, 1 μ F	ATC	920C105
C12, C18	Electrolytic capacitor, 100 μ F, 50 V	Digi-Key	PCE3718CT-ND
C21, C22, C24	Ceramic capacitor, 1.7 pF	ATC	100B 1R7
L1, L2	Ferrite, 8.9 mm	Elna Magnetics	BDS 4.6/3/8.9-4S2
Q1	Transistor	Infineon Technologies	BCP56
QQ1	Voltage regulator	National Semiconductor	LM7805
R1	Chip resistor, 1.2k ohms	Digi-Key	P1.2KGCT-ND
R2	Chip resistor, 1.3k ohms	Digi-Key	P1.3KGCT-ND
R3	Chip resistor, 2k ohms	Digi-Key	P2KECT-ND
R4	Potentiometer, 2k ohms	Digi-Key	3224W-202ETR-ND
R5, R7	Chip resistor, 5.1k ohms	Digi-Key	P5.1KECT-ND
R6	Chip resistor, 10 ohms	Digi-Key	P10ECT-ND

*Gerber Files for this circuit available on request

Package Outline Specifications

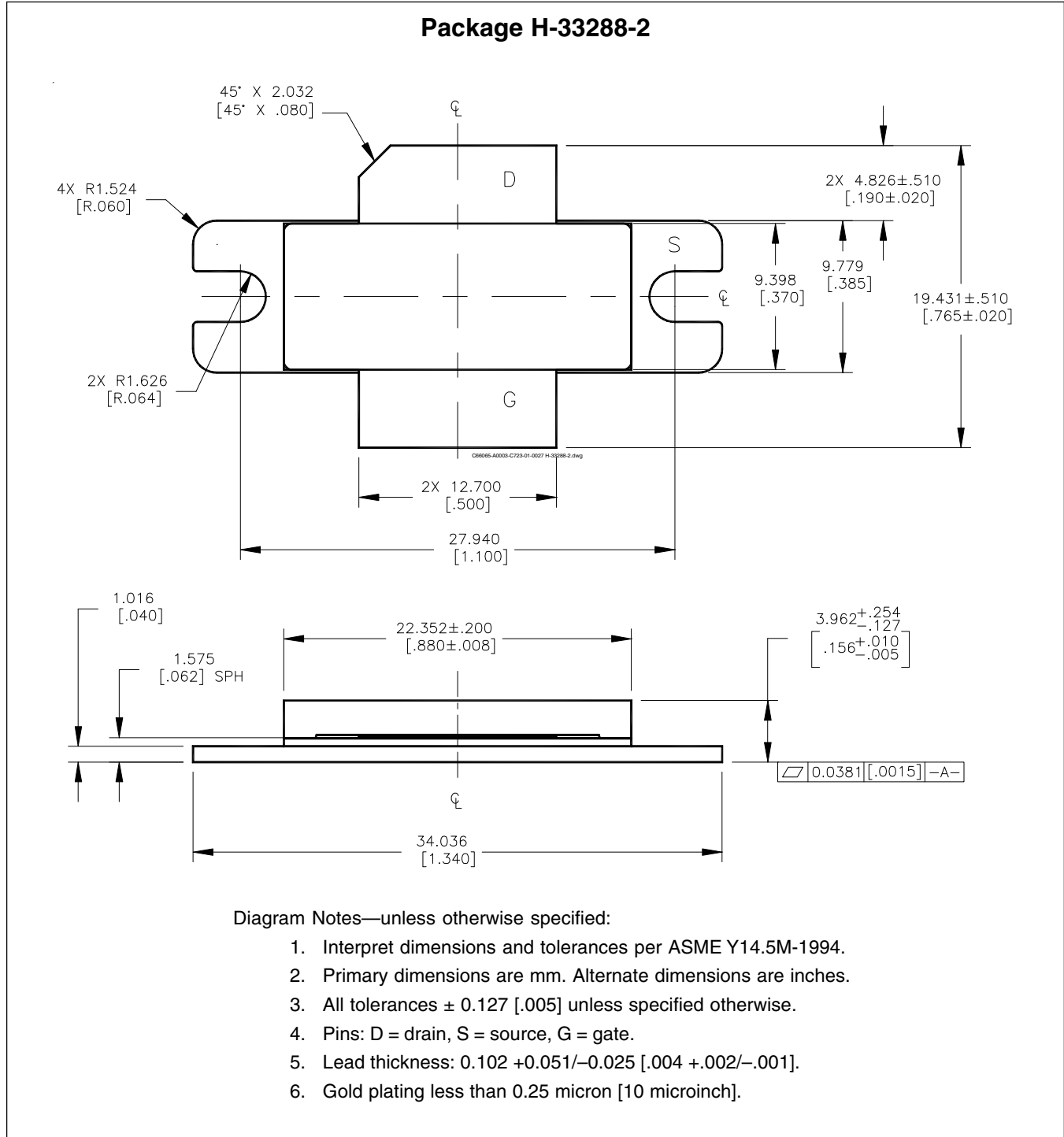

Find the latest and most complete information about products and packaging at the Infineon Internet page <http://www.infineon.com/rfpower>

Package Outline Specifications (cont.)

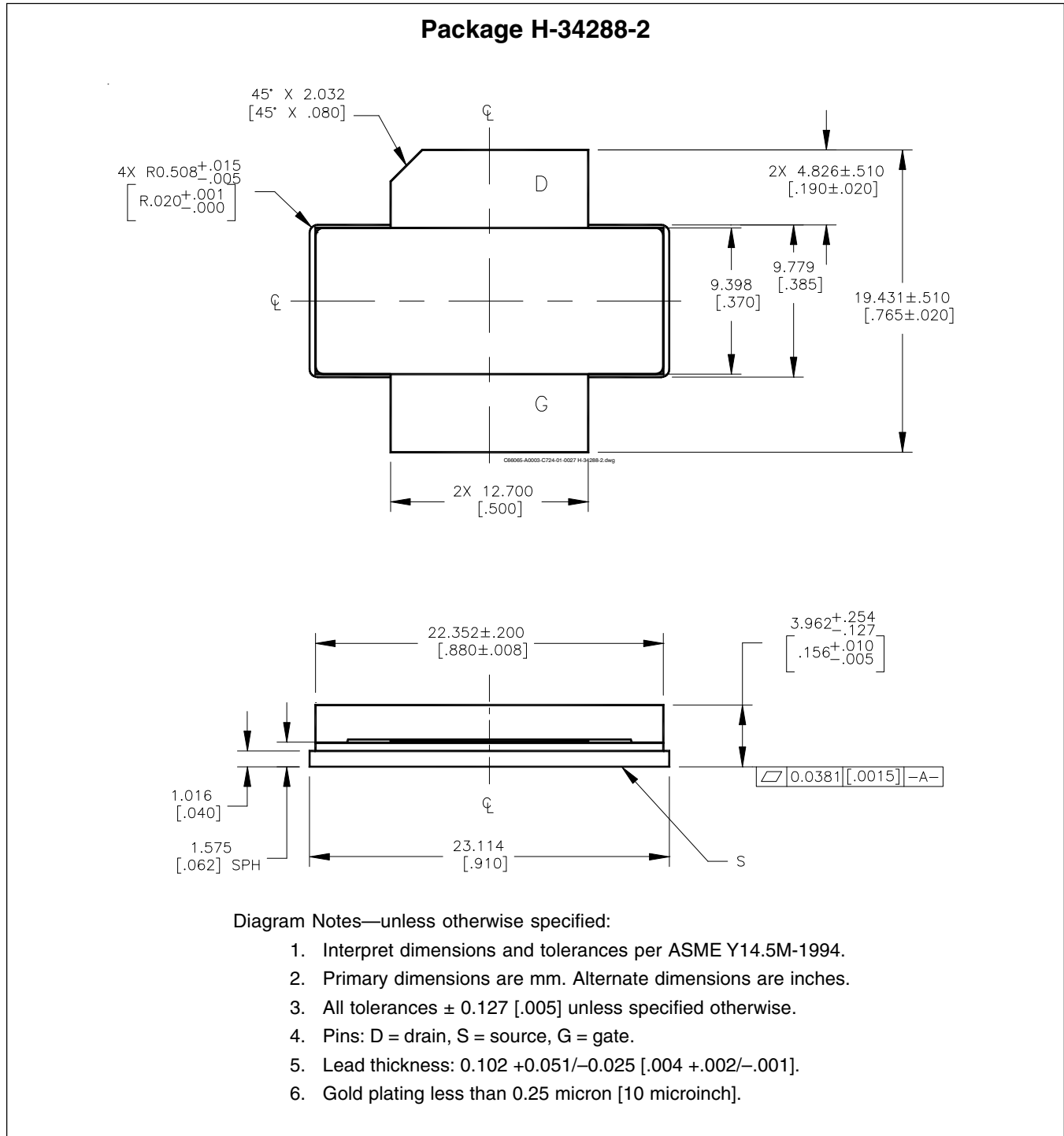

Find the latest and most complete information about products and packaging at the Infineon Internet page <http://www.infineon.com/rfpower>

Revision History: 2009-07-16 Data Sheet

Previous Version: 2009-03-31, Data Sheet

Page	Subjects (major changes since last revision)
6, 7	Fixed typing error

We Listen to Your Comments

Any information within this document that you feel is wrong, unclear or missing at all? Your feedback will help us to continuously improve the quality of this document. Please send your proposal (including a reference to this document) to:

highpowerRF@infineon.com

To request other information, contact us at:
+1 877 465 3667 (1-877-GO-LDMOS) USA
or +1 408 776 0600 International

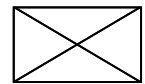

Edition 2009-07-16

Published by
Infineon Technologies AG
81726 Munich, Germany

© 2009 Infineon Technologies AG
All Rights Reserved.

Legal Disclaimer

The information given in this document shall in no event be regarded as a guarantee of conditions or characteristics. With respect to any examples or hints given herein, any typical values stated herein and/or any information regarding the application of the device, Infineon Technologies hereby disclaims any and all warranties and liabilities of any kind, including without limitation, warranties of non-infringement of intellectual property rights of any third party.

Information

For further information on technology, delivery terms and conditions and prices, please contact the nearest Infineon Technologies Office (www.infineon.com/rfpower).

Warnings

Due to technical requirements, components may contain dangerous substances. For information on the types in question, please contact the nearest Infineon Technologies Office.

Infineon Technologies components may be used in life-support devices or systems only with the express written approval of Infineon Technologies, if a failure of such components can reasonably be expected to cause the failure of that life-support device or system or to affect the safety or effectiveness of that device or system. Life support devices or systems are intended to be implanted in the human body or to support and/or maintain and sustain and/or protect human life. If they fail, it is reasonable to assume that the health of the user or other persons may be endangered.