

# BCR6AM

MEDIUM POWER USE

NON-INSULATED TYPE, PLANAR PASSIVATION TYPE

Refer to the page 6 as to the product guaranteed maximum junction temperature 150°C

**BCR6AM**



- **IT (RMS)** ..... **6A**
- **VDRM** ..... **600V**
- **IFGT I , IRGT I , IRGT III** ..... **20mA**

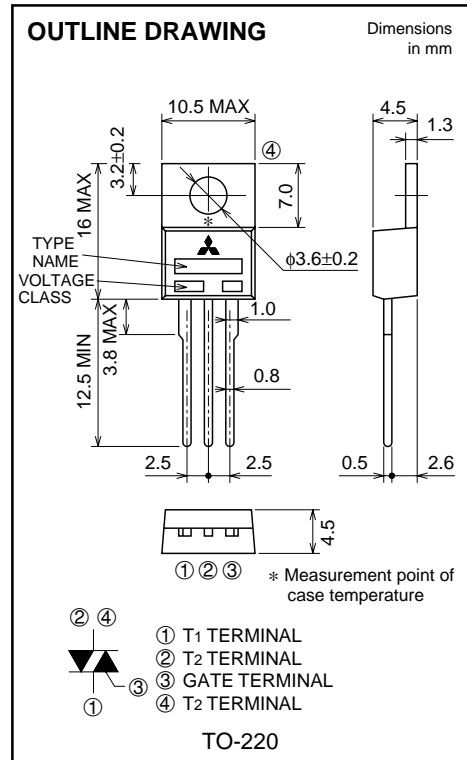

### APPLICATION

Contactless AC switches, light dimmer, electric flasher unit, control of household equipment such as TV sets · stereo · washing machine · infrared kotatsu · carpet · electric fan, solenoid drivers, small motor control, copying machine, other general purpose control applications

### MAXIMUM RATINGS

Symbol	Parameter	Voltage class		Unit
		12	600	
VDRM	Repetitive peak off-state voltage *1	600		V
VDSM	Non-repetitive peak off-state voltage *1	720		V

Symbol	Parameter	Conditions	Ratings	Unit
IT (RMS)	RMS on-state current	Commercial frequency, sine full wave 360° conduction, Tc=103°C*3	6	A
ITSM	Surge on-state current	60Hz sinewave 1 full cycle, peak value, non-repetitive	60	A
I <sup>2</sup> t	I <sup>2</sup> t for fusing	Value corresponding to 1 cycle of half wave 60Hz, surge on-state current	15	A <sup>2</sup> s
PGM	Peak gate power dissipation		5	W
PG (AV)	Average gate power dissipation		0.5	W
VGM	Peak gate voltage		10	V
IGM	Peak gate current		2	A
Tj	Junction temperature		-40 ~ +125	°C
Tstg	Storage temperature		-40 ~ +125	°C
—	Weight	Typical value	2.0	g

\*1. Gate open.

**BCR6AM**

Refer to the page 6 as to the product guaranteed maximum junction temperature 150°C

**MEDIUM POWER USE**  
**NON-INSULATED TYPE, PLANAR PASSIVATION TYPE**

**ELECTRICAL CHARACTERISTICS**

Symbol	Parameter	Test conditions	Limits			Unit	
			Min.	Typ.	Max.		
IDRM	Repetitive peak off-state current	T <sub>j</sub> =125°C, V <sub>DRM</sub> applied	—	—	2.0	mA	
V <sub>TM</sub>	On-state voltage	T <sub>c</sub> =25°C, I <sub>TM</sub> =9A, Instantaneous measurement	—	—	1.7	V	
V <sub>FGT I</sub>	Gate trigger voltage *2	T <sub>j</sub> =25°C, V <sub>D</sub> =6V, R <sub>L</sub> =6Ω, R <sub>G</sub> =330Ω	I	—	—	1.5	V
V <sub>RGT I</sub>			II	—	—	1.5	V
V <sub>RGT III</sub>			III	—	—	1.5	V
I <sub>FGT I</sub>	Gate trigger current *2	T <sub>j</sub> =25°C, V <sub>D</sub> =6V, R <sub>L</sub> =6Ω, R <sub>G</sub> =330Ω	I	—	—	20	mA
I <sub>RGT I</sub>			II	—	—	20	mA
I <sub>RGT III</sub>			III	—	—	20	mA
V <sub>GD</sub>	Gate non-trigger voltage	T <sub>j</sub> =125°C, V <sub>D</sub> =1/2V <sub>DRM</sub>	0.2	—	—	V	
R <sub>th (j-c)</sub>	Thermal resistance	Junction to case *3 *4	—	—	2.5	°C/W	
(dv/dt) <sub>c</sub>	Critical-rate of rise of off-state commutating voltage *5	T <sub>j</sub> =125°C	10	—	—	V/μs	

\*2. Measurement using the gate trigger characteristics measurement circuit.  
 \*3. Case temperature is measured at the T2 terminal 1.5mm away from the molded case.  
 \*4. The contact thermal resistance R<sub>th (c-f)</sub> in case of greasing is 1.0°C/W.  
 \*5. Test conditions of the critical-rate of rise of off-state commutating voltage is shown in the table below.

Test conditions	Commutating voltage and current waveforms (inductive load)
1. Junction temperature T <sub>j</sub> =125°C  2. Rate of decay of on-state commutating current (di/dt) <sub>c</sub> =-3.0A/ms  3. Peak off-state voltage V <sub>D</sub> =400V	

**PERFORMANCE CURVES**

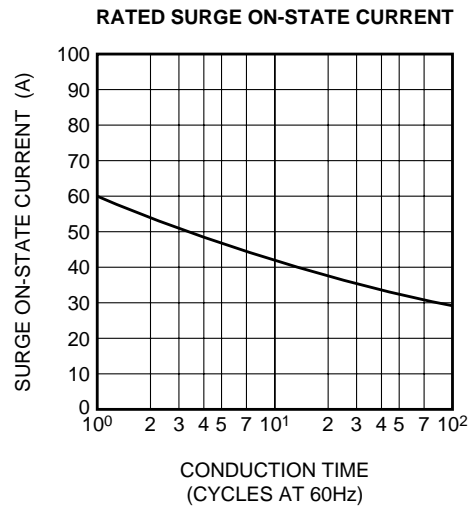
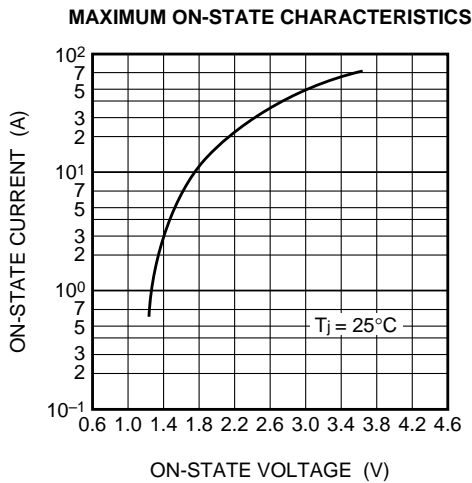

# BCR6AM

Refer to the page 6 as to the product guaranteed maximum junction temperature 150°C

MEDIUM POWER USE  
NON-INSULATED TYPE, PLANAR PASSIVATION TYPE

**GATE CHARACTERISTICS (I, II AND III)**

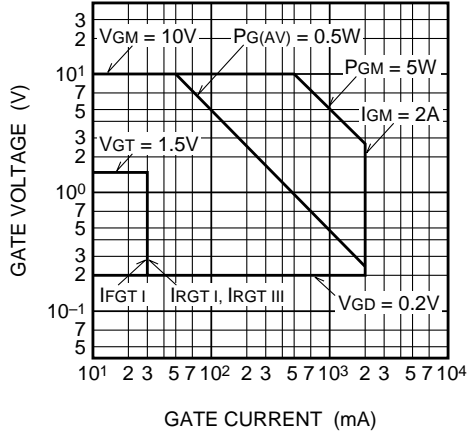

**GATE TRIGGER CURRENT VS. JUNCTION TEMPERATURE**

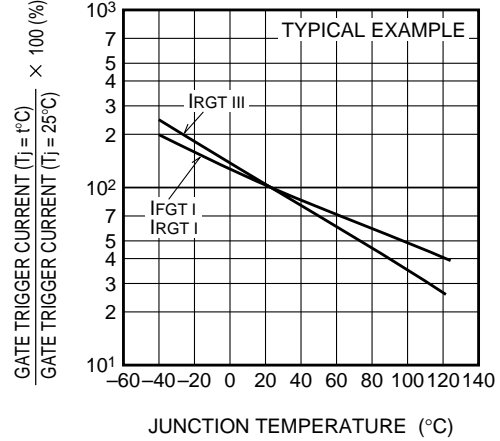

**GATE TRIGGER VOLTAGE VS. JUNCTION TEMPERATURE**

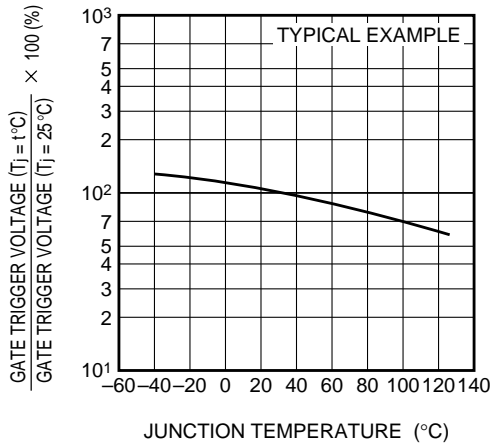

**MAXIMUM TRANSIENT THERMAL IMPEDANCE CHARACTERISTICS (JUNCTION TO CASE)**

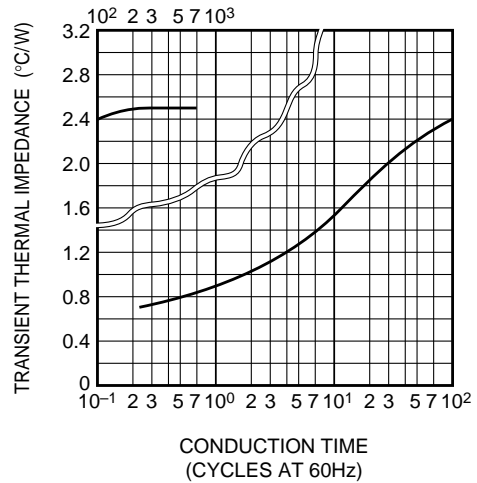

**MAXIMUM ON-STATE POWER DISSIPATION**

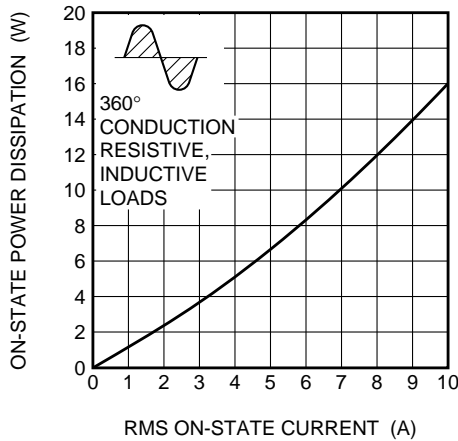

**ALLOWABLE CASE TEMPERATURE VS. RMS ON-STATE CURRENT**

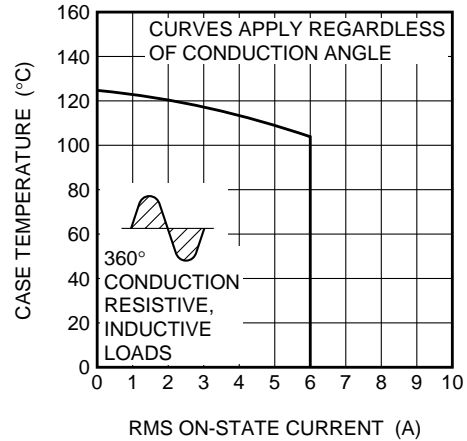

**BCR6AM**

Refer to the page 6 as to the product guaranteed maximum junction temperature 150°C

**MEDIUM POWER USE**  
**NON-INSULATED TYPE, PLANAR PASSIVATION TYPE**

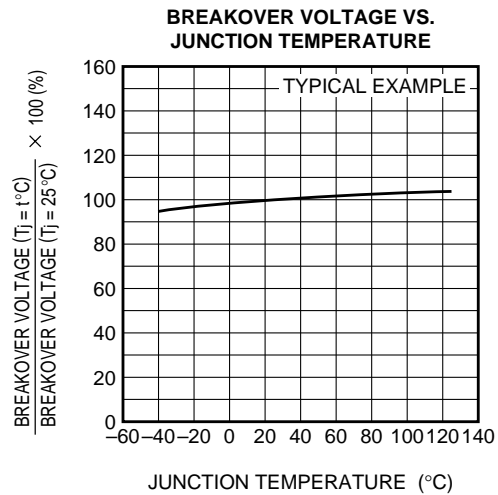
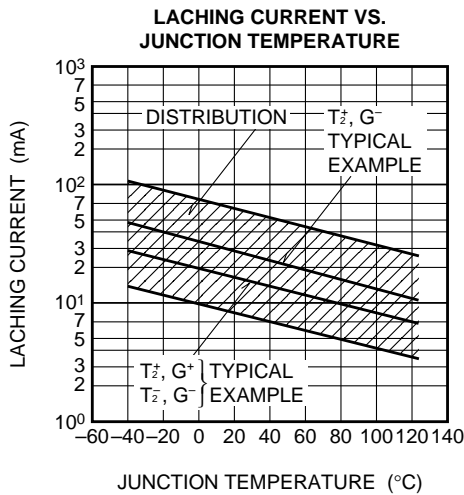
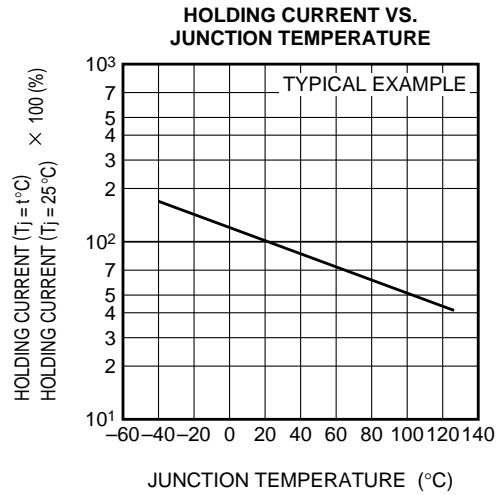
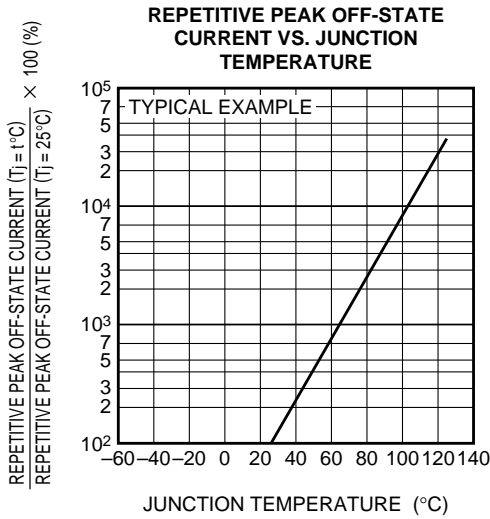
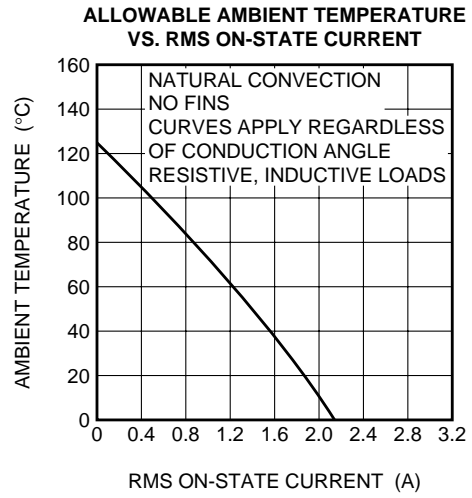
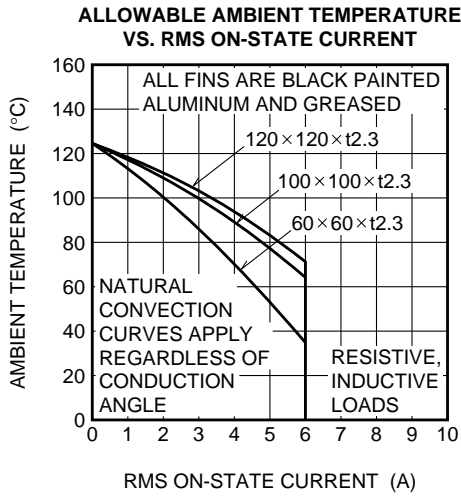

# BCR6AM

Refer to the page 6 as to the product guaranteed maximum junction temperature 150°C

MEDIUM POWER USE  
NON-INSULATED TYPE, PLANAR PASSIVATION TYPE

**BREAKEOVER VOLTAGE VS. RATE OF RISE OF OFF-STATE VOLTAGE**

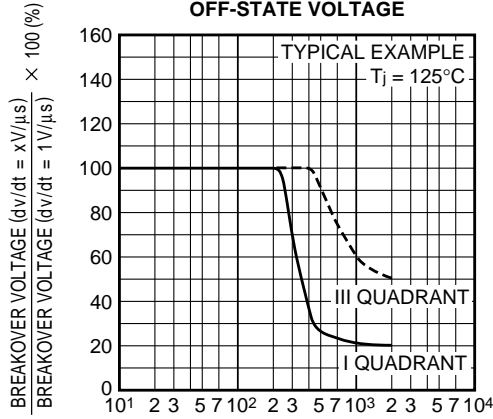

RATE OF RISE OF OFF-STATE VOLTAGE ( $V/\mu s$ )

**COMMUTATION CHARACTERISTICS**

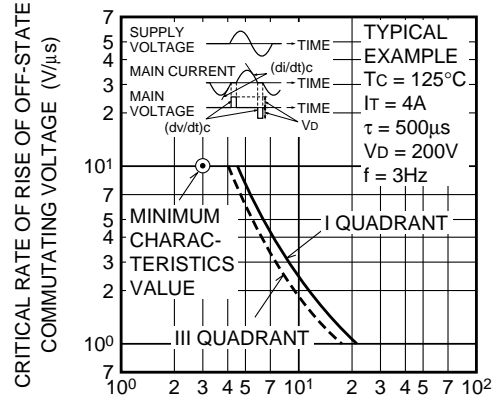

RATE OF DECAY OF ON-STATE COMMUTATING CURRENT ( $A/ms$ )

**GATE TRIGGER CURRENT VS. GATE CURRENT PULSE WIDTH**

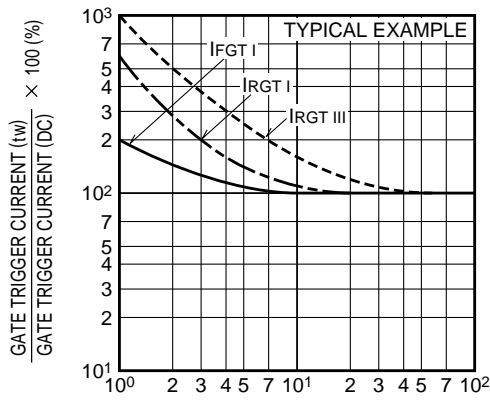

GATE CURRENT PULSE WIDTH ( $\mu s$ )

**GATE TRIGGER CHARACTERISTICS TEST CIRCUITS**

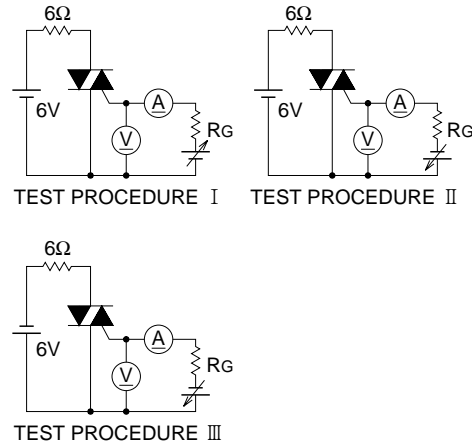

# BCR6AM

MEDIUM POWER USE

NON-INSULATED TYPE, PLANAR PASSIVATION TYPE

The product guaranteed maximum junction temperature 150°C (See warning.)

**BCR6AM**



- **IT (RMS)** ..... **6A**
- **VDRM** ..... **600V**
- **IFGT I , IRGT I , IRGT III** ..... **20mA**

**OUTLINE DRAWING** Dimensions in mm

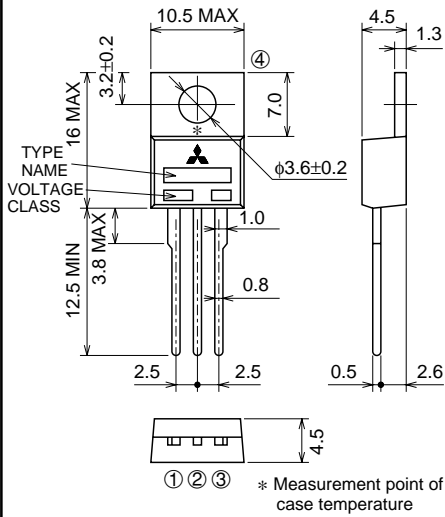

① ② ③ \* Measurement point of case temperature

① T1 TERMINAL  
② T2 TERMINAL  
③ GATE TERMINAL  
④ T2 TERMINAL

TO-220

## APPLICATION

Contactless AC switches, light dimmer, electric flasher unit, control of household equipment such as TV sets · stereo · washing machine · infrared kotatsu · carpet · electric fan, solenoid drivers, small motor control, copying machine, other general purpose control applications

(Warning)

1. Refer to the recommended circuit values around the triac before using.
2. Be sure to exchange the specification before using. If not exchanged, general triacs will be supplied.

## MAXIMUM RATINGS

Symbol	Parameter	Voltage class		Unit
		12	600	
VDRM	Repetitive peak off-state voltage *1	600		V
VDSM	Non-repetitive peak off-state voltage *1	720		V

Symbol	Parameter	Conditions	Ratings	Unit
IT (RMS)	RMS on-state current	Commercial frequency, sine full wave 360° conduction, Tc=128°C*3	6	A
ITSM	Surge on-state current	60Hz sinewave 1 full cycle, peak value, non-repetitive	60	A
I <sup>2</sup> t	I <sup>2</sup> t for fusing	Value corresponding to 1 cycle of half wave 60Hz, surge on-state current	15	A <sup>2</sup> s
PGM	Peak gate power dissipation		5	W
PG (AV)	Average gate power dissipation		0.5	W
VGM	Peak gate voltage		10	V
IGM	Peak gate current		2	A
Tj	Junction temperature		-40 ~ +150	°C
Tstg	Storage temperature		-40 ~ +150	°C
—	Weight	Typical value	2.0	g

\*1. Gate open.

# BCR6AM

The product guaranteed maximum junction temperature 150°C (See warning.)

**MEDIUM POWER USE**  
**NON-INSULATED TYPE, PLANAR PASSIVATION TYPE**

## ELECTRICAL CHARACTERISTICS

Symbol	Parameter	Test conditions	Limits			Unit	
			Min.	Typ.	Max.		
IDRM	Repetitive peak off-state current	T <sub>j</sub> =150°C, V <sub>DRM</sub> applied	—	—	2.0	mA	
V <sub>TM</sub>	On-state voltage	T <sub>c</sub> =25°C, I <sub>TM</sub> =9A, Instantaneous measurement	—	—	1.7	V	
V <sub>FGT I</sub>	Gate trigger voltage *2	T <sub>j</sub> =25°C, V <sub>D</sub> =6V, R <sub>L</sub> =6Ω, R <sub>G</sub> =330Ω	I	—	—	1.5	V
V <sub>RGT I</sub>			II	—	—	1.5	V
V <sub>RGT III</sub>			III	—	—	1.5	V
I <sub>FGT I</sub>	Gate trigger current *2	T <sub>j</sub> =25°C, V <sub>D</sub> =6V, R <sub>L</sub> =6Ω, R <sub>G</sub> =330Ω	I	—	—	20	mA
I <sub>RGT I</sub>			II	—	—	20	mA
I <sub>RGT III</sub>			III	—	—	20	mA
V <sub>GD</sub>	Gate non-trigger voltage	T <sub>j</sub> =125°C/150°C, V <sub>D</sub> =1/2V <sub>DRM</sub>	0.2/0.1	—	—	V	
R <sub>th (j-c)</sub>	Thermal resistance	Junction to case *3 *4	—	—	2.5	°C/W	
(dv/dt) <sub>c</sub>	Critical-rate of rise of off-state commutating voltage *5	T <sub>j</sub> =125°C/150°C	10/1	—	—	V/μs	

\*2. Measurement using the gate trigger characteristics measurement circuit.

\*3. Case temperature is measured at the T2 terminal 1.5mm away from the molded case.

\*4. The contact thermal resistance R<sub>th (c-f)</sub> in case of greasing is 1.0°C/W.

\*5. Test conditions of the critical-rate of rise of off-state commutating voltage is shown in the table below.

Test conditions	Commutating voltage and current waveforms (inductive load)
1. Junction temperature T <sub>j</sub> =125°C/150°C  2. Rate of decay of on-state commutating current (di/dt) <sub>c</sub> =-3.0A/ms  3. Peak off-state voltage V <sub>D</sub> =400V	

## PERFORMANCE CURVES

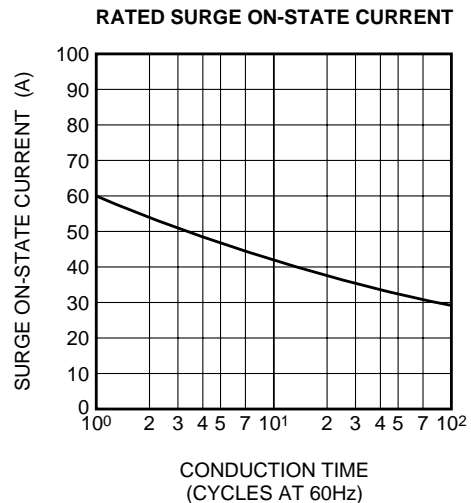
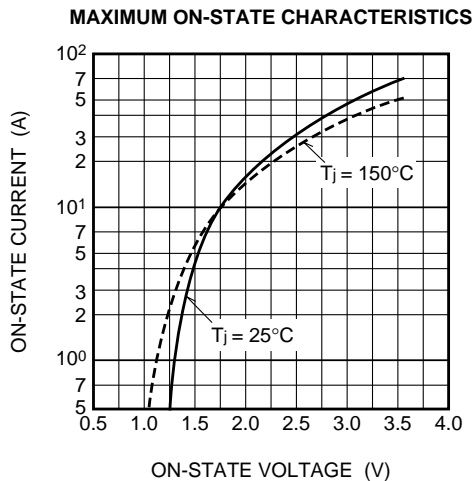

**BCR6AM**

The product guaranteed maximum junction temperature 150°C (See warning.)

**MEDIUM POWER USE**  
**NON-INSULATED TYPE, PLANAR PASSIVATION TYPE**

**GATE CHARACTERISTICS**  
(I, II AND III)

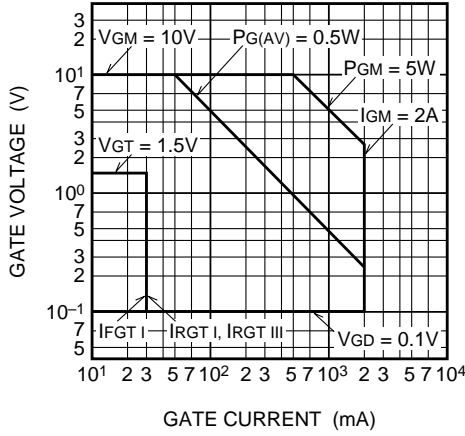

**GATE TRIGGER CURRENT VS. JUNCTION TEMPERATURE**

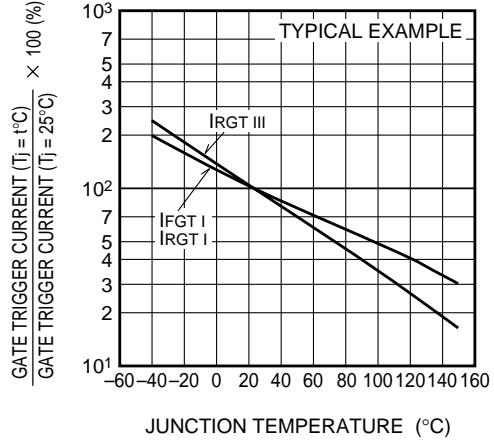

**GATE TRIGGER VOLTAGE VS. JUNCTION TEMPERATURE**

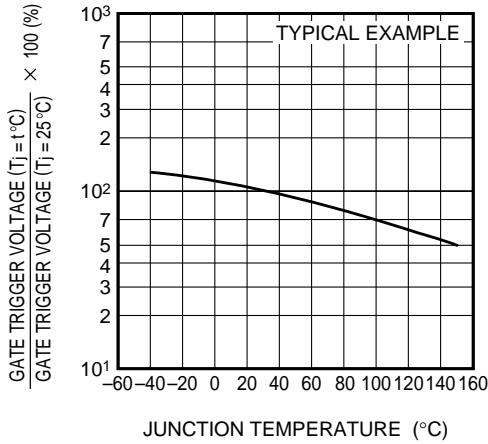

**MAXIMUM TRANSIENT THERMAL IMPEDANCE CHARACTERISTICS**  
(JUNCTION TO CASE)

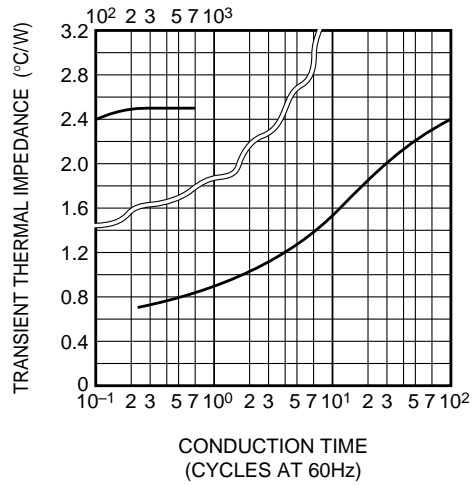

**MAXIMUM ON-STATE POWER DISSIPATION**

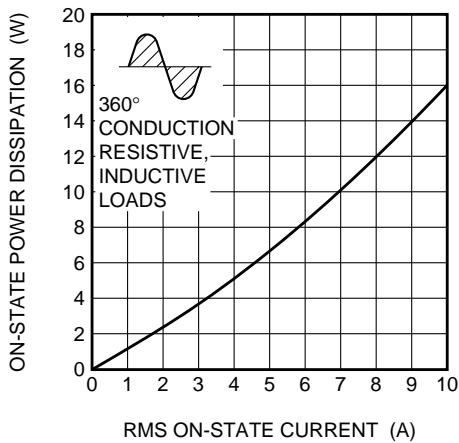

**ALLOWABLE CASE TEMPERATURE VS. RMS ON-STATE CURRENT**

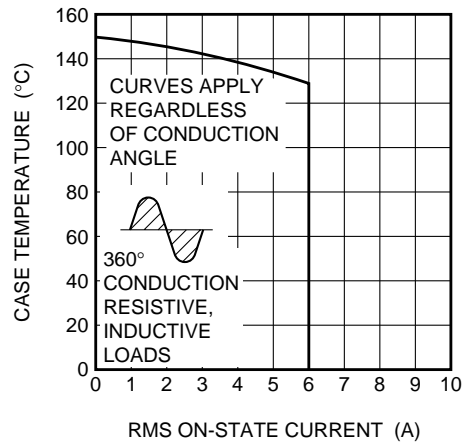



**BCR6AM**

The product guaranteed maximum junction temperature 150°C (See warning.)

**MEDIUM POWER USE**  
**NON-INSULATED TYPE, PLANAR PASSIVATION TYPE**

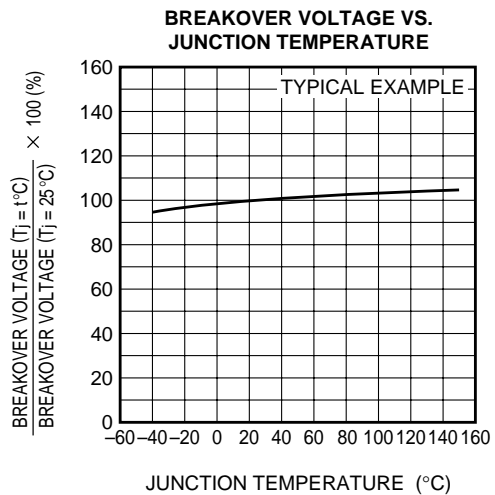
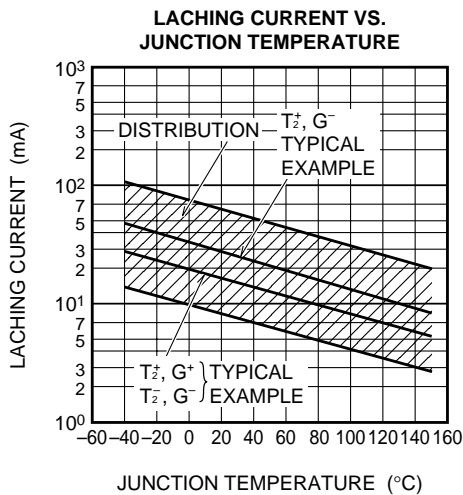
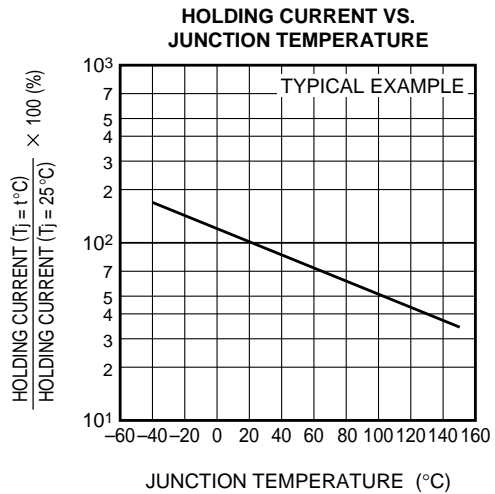
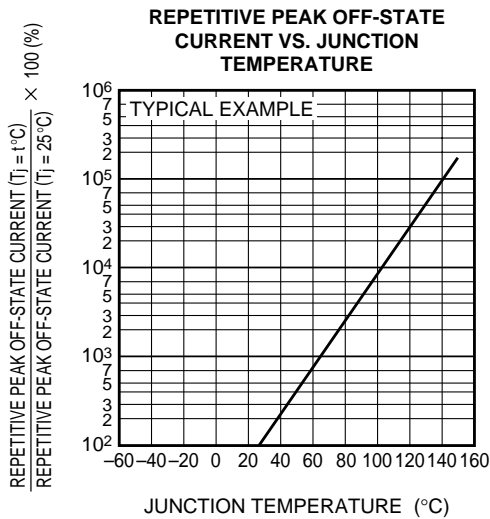
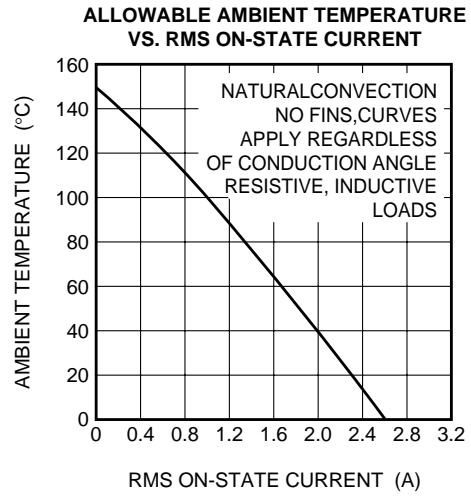
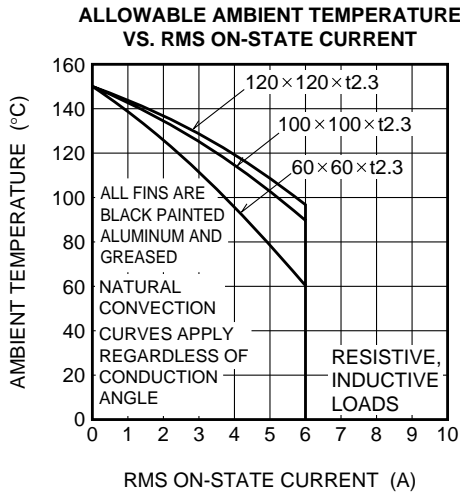

**BCR6AM**

The product guaranteed maximum junction temperature 150°C (See warning.)

**MEDIUM POWER USE**  
**NON-INSULATED TYPE, PLANAR PASSIVATION TYPE**

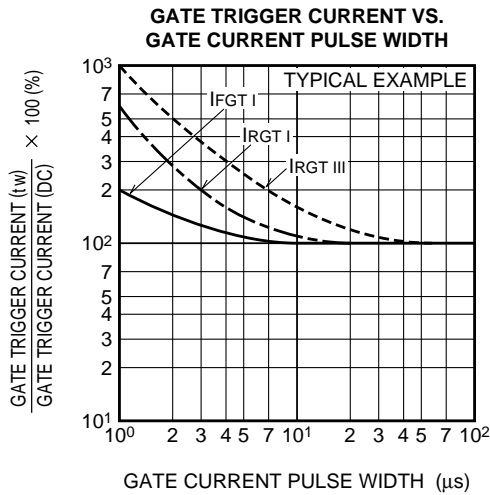
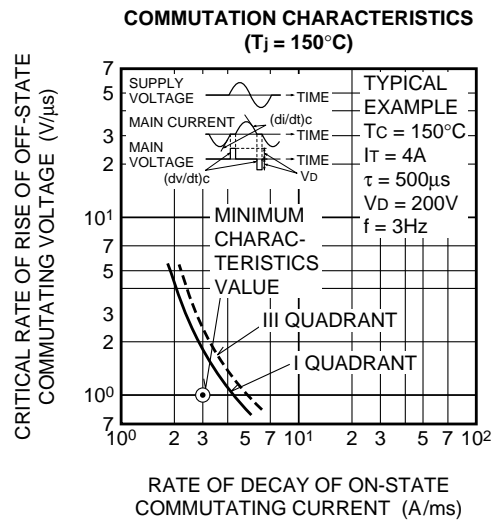
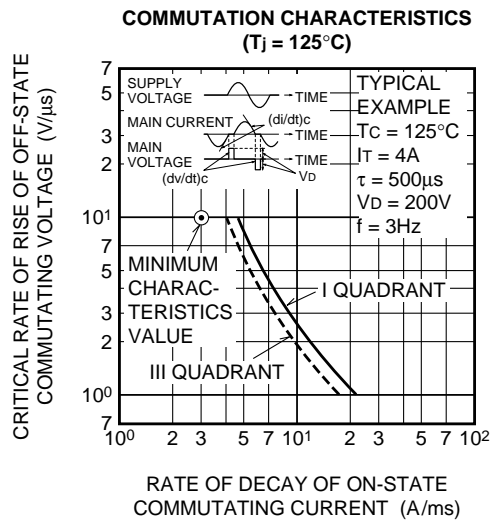
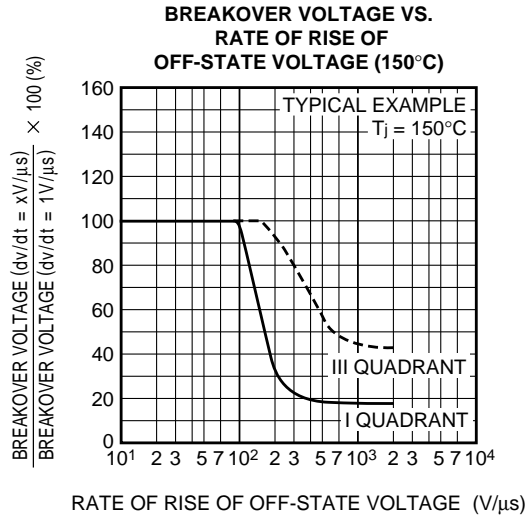
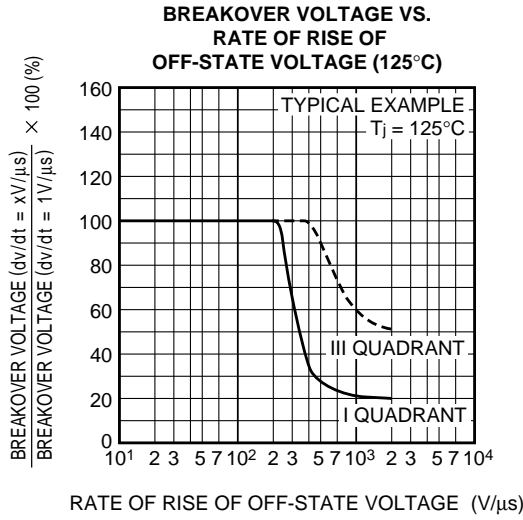

# BCR6AM

The product guaranteed maximum junction temperature 150°C (See warning.)

**MEDIUM POWER USE**  
**NON-INSULATED TYPE, PLANAR PASSIVATION TYPE**

### GATE TRIGGER CHARACTERISTICS TEST CIRCUITS

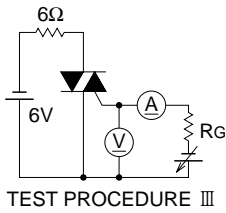
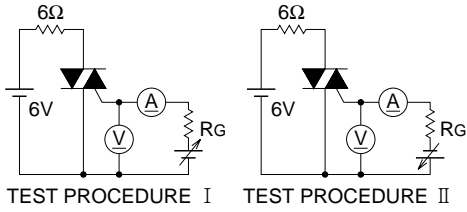

### RECOMMENDED CIRCUIT VALUES AROUND THE TRIAC

