

# FAN5602

## Universal (Step-Up/Step-Down) Charge Pump Regulated DC/DC Converter

### Features

- Low Noise Constant Frequency Operation at Heavy Load
- High Efficiency Pulse-Skip (PFM) Operation at Light Load
- Adaptive Seven Switch Configurations (1:3, 1:2, 2:3, 1:1, 3:2, 2:1, 3:1)
- 92% Peak Efficiency
- Input Voltage Range: 2.7V to 5.5V
- Output Current: 3.3V, 200mA at  $V_{IN} = 3.6V$
- $\pm 3\%$  Output Voltage Accuracy
- $I_{CC} < 1\mu A$  in Shutdown Mode
- 1MHz Operating Frequency
- Shutdown Isolates Output from Input
- Soft-Start Limits Inrush Current at Start-up
- Short Circuit and Over Temperature Protection
- Minimum External Component Count
- No Inductors

### Applications

- Cell Phones
- Handheld Computers
- Portable RF Communication Equipment
- Core Supply to Low Power Processors
- Low Voltage DC Bus
- DSP Supplies

### Description

The FAN5602 is a universal switched capacitor DC/DC converter capable of step-up or step-down operation. Due to its unique adaptive fractional switching topology, the device achieves high efficiency over a wider input/output voltage range than any of its predecessors. The FAN5602 utilizes resistance modulated loop control, which produces lower switching noise than other topologies. Depending upon actual load conditions, the device automatically switches between constant frequency and pulse skipping (PFM) modes of operation in order to extend battery life. The FAN5602 produces a fixed regulated output within the range of 2.7V to 5.5V from any type of voltage source. High efficiency is achieved under any input/output voltage conditions because an internal logic circuitry automatically reconfigures the system to the best possible topology. Only two  $1\mu F$  bucket capacitors and one  $10\mu F$  output capacitor are needed. During power on soft start circuitry prevents excessive current drawn from the supply. The device is protected against short circuit and over temperature conditions.

The FAN5602 is available with 3.3V, 4.5V, and 5.0V output voltage. Any other output voltage option within the 1.5V to 5V range is available upon request. The FAN5602 is available in 8-lead MSOP and 3x3mm 8-lead MLP packages

### Typical Application

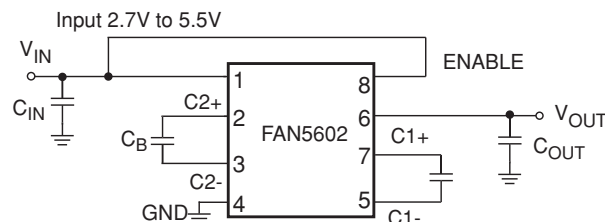

## Pin Assignment

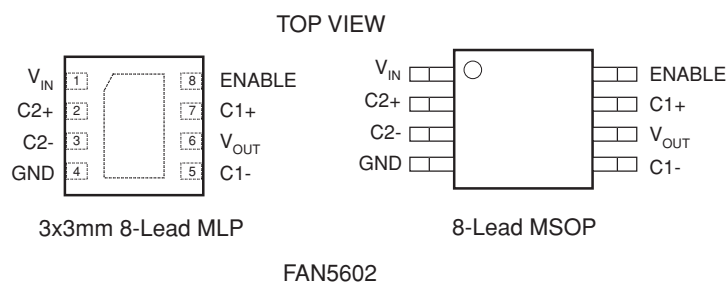

## Pin Description

Pin No.	Pin Name	Pin Description
1	$V_{IN}$	Supply Voltage Input
2	C2+	Bucket Capacitor2 Positive Connection
3	C2-	Bucket Capacitor2 Negative Connection
4	GND	Ground
5	C1-	Bucket Capacitor1 Negative Connection
6	$V_{OUT}$	Regulated Output Voltage. Bypass this pin with 10 $\mu$ F ceramic low ESR capacitor.
7	C1+	Bucket Capacitor1 Positive Connection
8	ENABLE	Enable Input. Logic high enables the chip and logic low disables the chip, reducing the supply current to less than 1 $\mu$ A. Do not float this pin.

**Absolute Maximum Ratings** (Note 1)

Parameter	Min	Typ	Max	Unit
$V_{IN}, V_{OUT}, \text{ENABLE}$ Voltage to GND	-0.3		6.0	V
Voltage at C1+, C1-, C2+, and C2- to GND	-0.3		$V_{IN} + 0.3$	V
Power Dissipation			Internally Limited	
Lead Soldering Temperature (10 seconds)			300	°C
Junction Temperature			150	°C
Storage Temperature	-55		150	°C
Electrostatic Discharge (ESD) Protection (Note 2)	HBM	2		kV
	CDM	2		

**Recommended Operating Conditions**

Parameter	Conditions	Min	Typ	Max	Unit
Input Voltage		1.8		5.5	V
Load Current (Note 3)	$V_{IN} < 2V$			30	mA
	3.3V, $V_{IN} = 3.6V$			200	mA
	4.5 & 5.0V, $V_{IN} = 3.6V$			100	mA
Ambient Temperature		-40		85	°C

**Notes:**

1. Operation beyond the absolute maximum rating may cause permanent damage to device.
2. Using Mil Std. 883E, method 3015.7(Human Body Model) and EIA/JESD22C101-A (Charge Device Model).
3. Refer to "load Current Capability vs Input Voltage" in "Typical Performance Characteristics".

## DC Electrical Characteristics

$V_{IN} = 2.7V$  to  $5.5V$ ,  $C_1 = C_2 = 1\mu F$ ,  $C_{IN} = C_{OUT} = 10\mu F$ ,  $ENABLE = V_{IN}$ ,  $T_A = -40^\circ C$  to  $+85^\circ C$  unless otherwise noted. Typical values are at  $T_A = 25^\circ C$ .

Parameter	Conditions	Min.	Typ.	Max.	Units
Input Undervoltage Lockout		1.5	1.7	2.2	V
Output Voltage, $V_{OUT}$	$V_{IN} \geq 0.75 \times V_{NOM}$ , $0mA < I_{LOAD} < 100mA$	$0.97 \times V_{NOM}$	$V_{NOM}$	$1.03 \times V_{NOM}$	V
Quiescent Current	$V_{IN} \geq 1.1 \times V_{NOM}$ , $I_{LOAD} = 0mA$		100	300	$\mu A$
Off Mode Supply Current	ENABLE = GND		0.1	1	$\mu A$
Output Short-circuit Current	$V_{OUT} < 150mV$			200	mA
Efficiency	$V_{IN} = 0.85 \times V_{NOM}$ , $I_{LOAD} = 30mA$	3.3V	75		%
		4.5V, 5.0V	80		
	$V_{IN} = 1.1 \times V_{NOM}$ , $I_{LOAD} = 30mA$	3.3V	90		%
		4.5V, 5.0V	92		
Oscillator Frequency	$T_A = 25^\circ C$	0.7	1.0	1.3	MHz
Thermal Shutdown Threshold			145		$^\circ C$
Thermal Shutdown Threshold Hysteresis			15		$^\circ C$
ENABLE Logic Input High Voltage, $V_{IH}$		1.5			V
ENABLE Logic Input Low Voltage, $V_{IL}$				0.5	V
ENABLE Input Bias Current	ENABLE = $V_{IN}$ or GND	-1		1	$\mu A$
$V_{OUT}$ Turn On Time	$V_{IN} = 0.9 \times V_{NOM}$ , $I_{LOAD} = 0mA$ , 10% to 90%		0.5		mS
$V_{OUT}$ Ripple	$V_{IN} = 2.5V$ $I_{LOAD} = 200mA$		10		mVpp

# Typical Performance Characteristics

$T_A = 25^\circ\text{C}$ ,  $V_{OUT} = 4.5\text{V}$  unless otherwise noted.

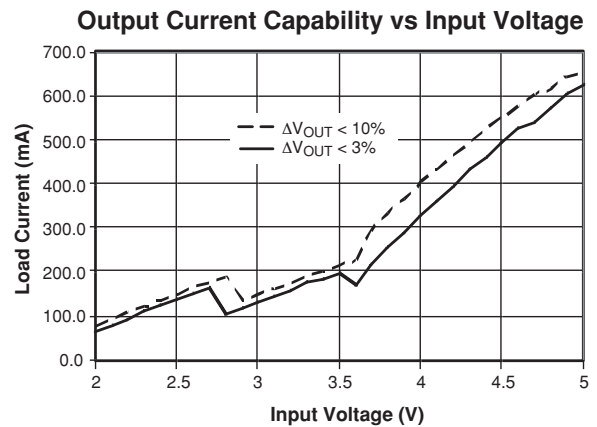
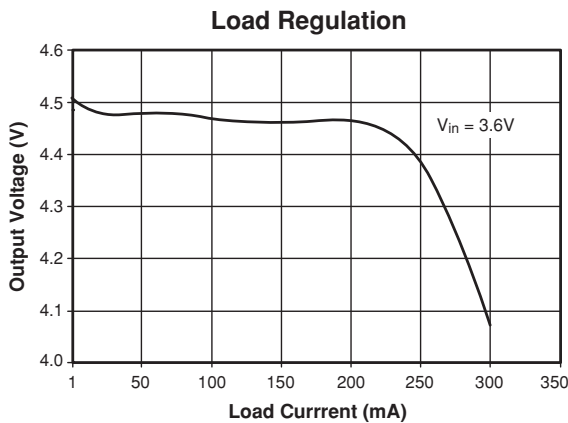
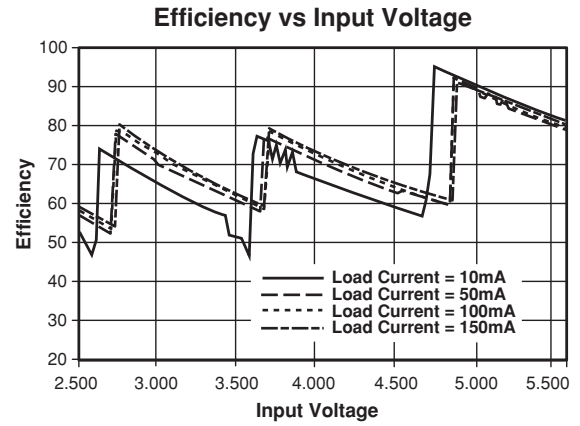
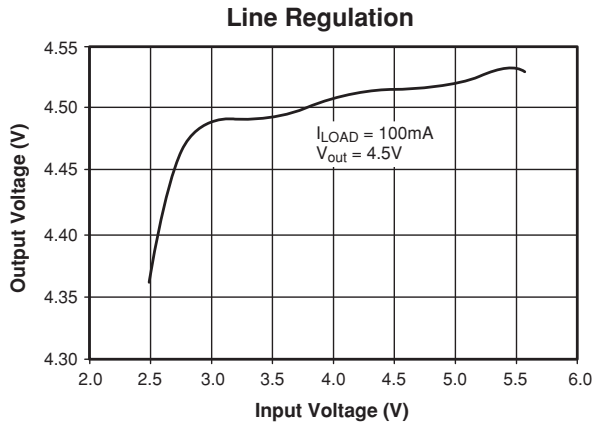
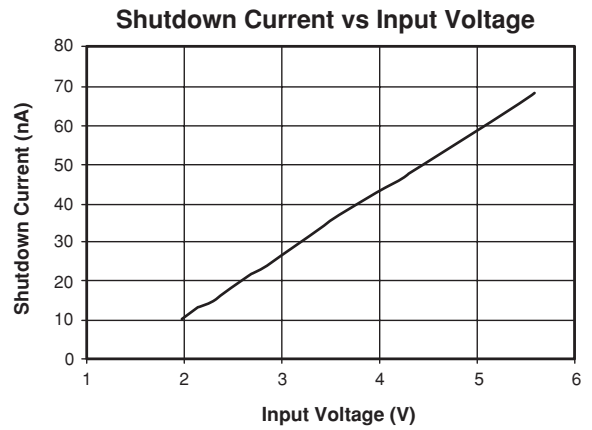
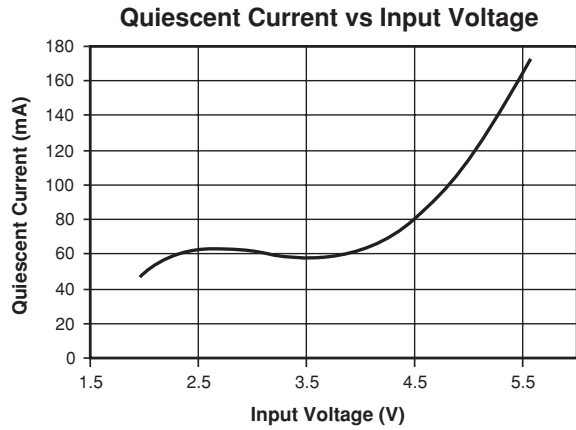

### Typical Performance Characteristics (cont)

$T_A = 25^\circ\text{C}$ ,  $V_{OUT} = 4.5\text{V}$  unless otherwise noted.

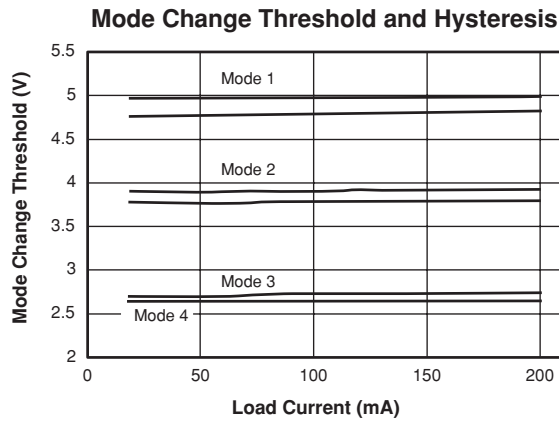
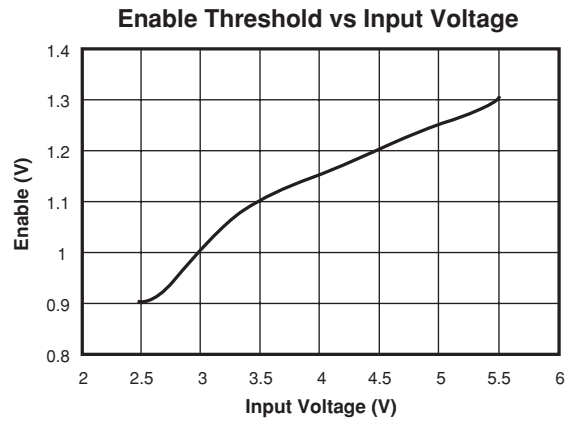
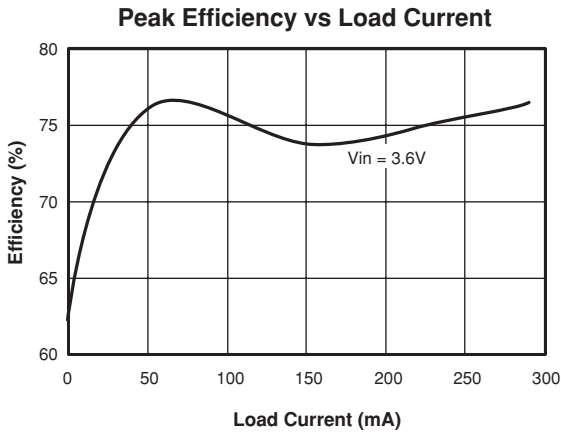
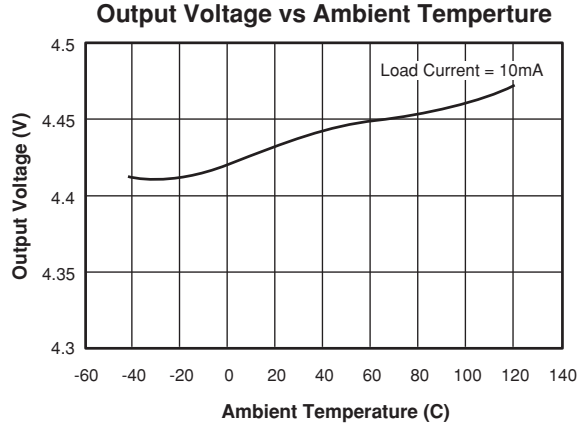
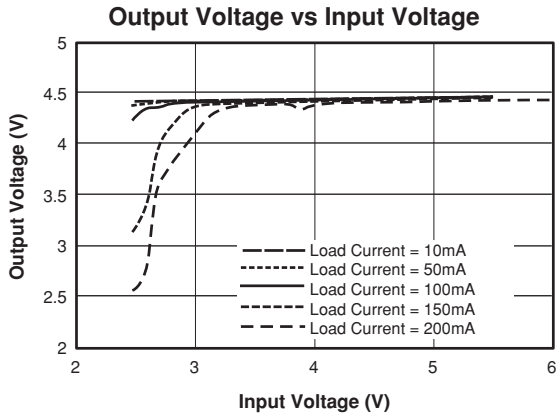

# Typical Performance Characteristics (cont)

$T_A = 25^\circ\text{C}$ ,  $V_{OUT} = 3.3\text{V}$  unless otherwise noted.

**Load Transient Response (LDO Mode)**

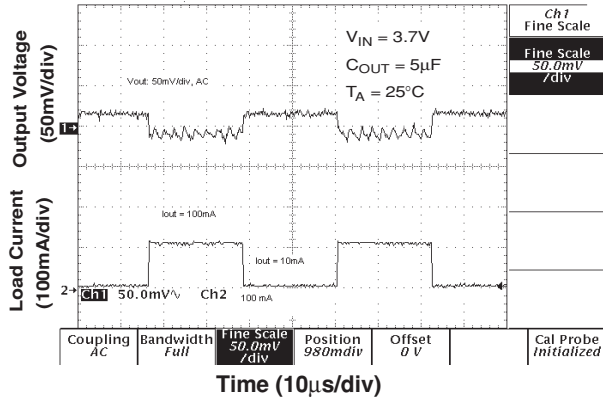

**Load Transient Response (2:3 Mode)**

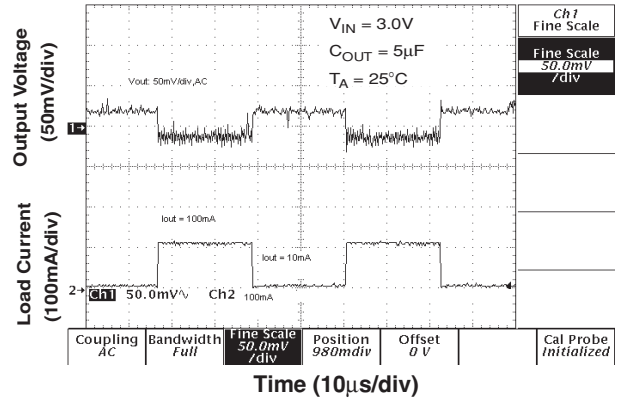

**Load Transient Response (1:2 Mode)**

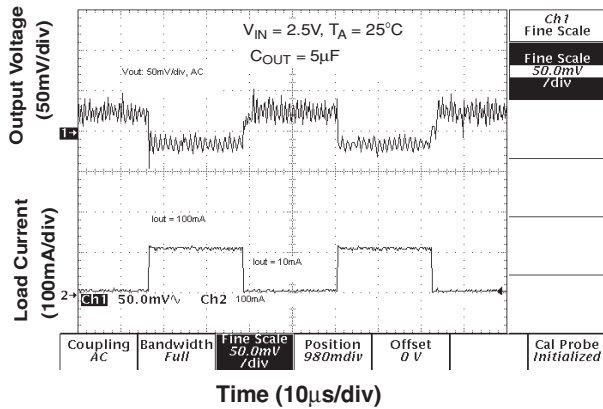

**Enable Delay**

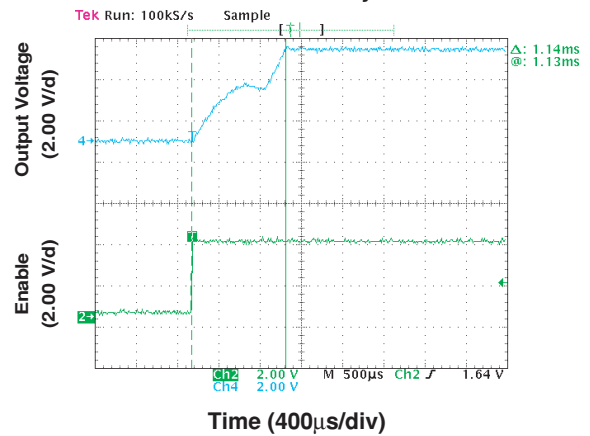

### Typical Performance Characteristics (cont)

$T_A = 25^\circ\text{C}$ ,  $C_{IN} = C_{OUT} = 10\mu\text{F}$ ,  $C_B = 1\mu\text{F}$ ,  $V_{OUT} = 4.5\text{V}$ , unless otherwise noted.

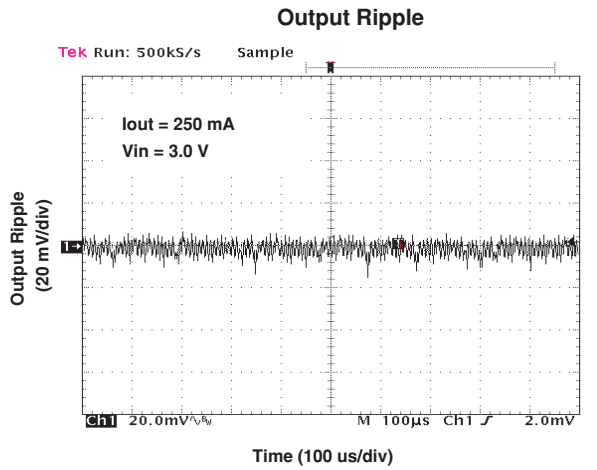
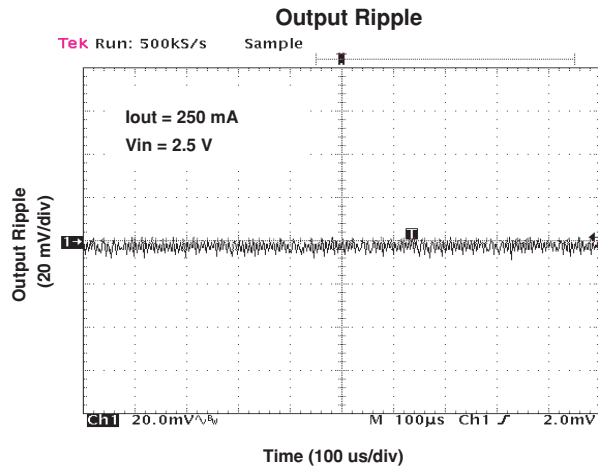
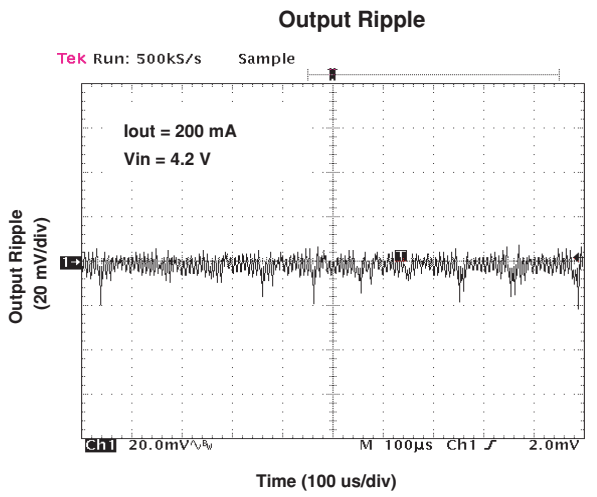
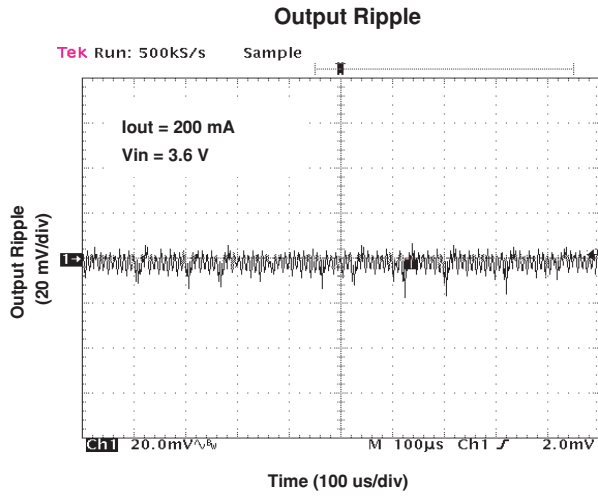
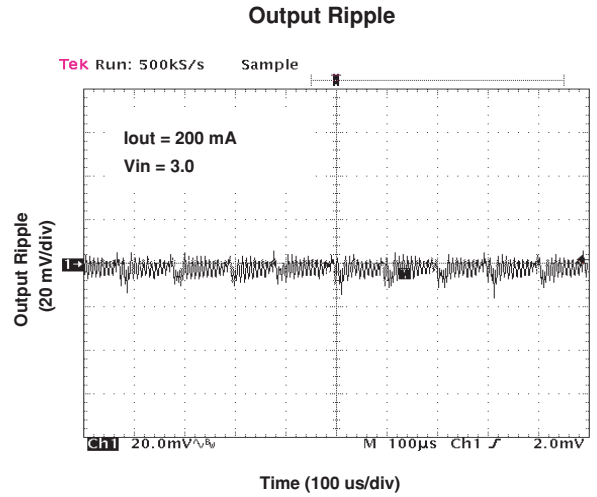
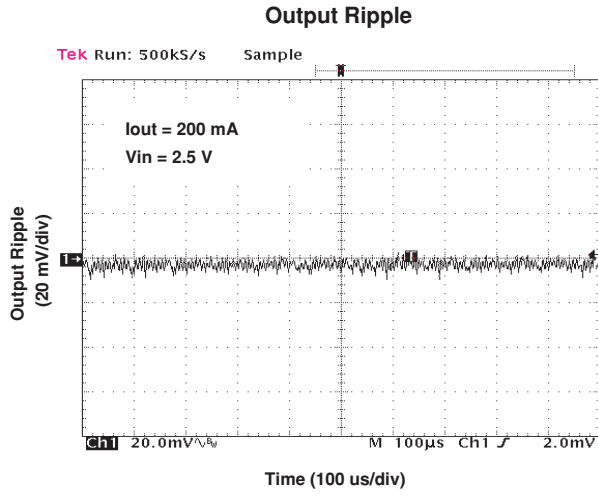



# Typical Performance Characteristics (cont)

$T_A = 25^\circ\text{C}$ ,  $C_{IN} = C_{OUT} = 10\mu\text{F}$ ,  $C_B = 1\mu\text{F}$ ,  $V_{OUT} = 4.5\text{V}$ , unless otherwise noted.

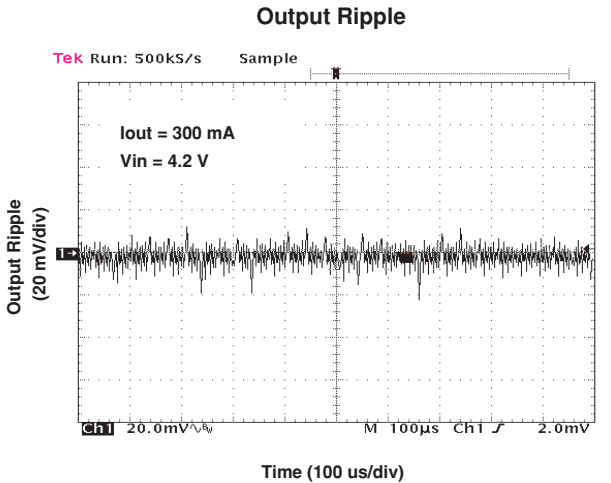
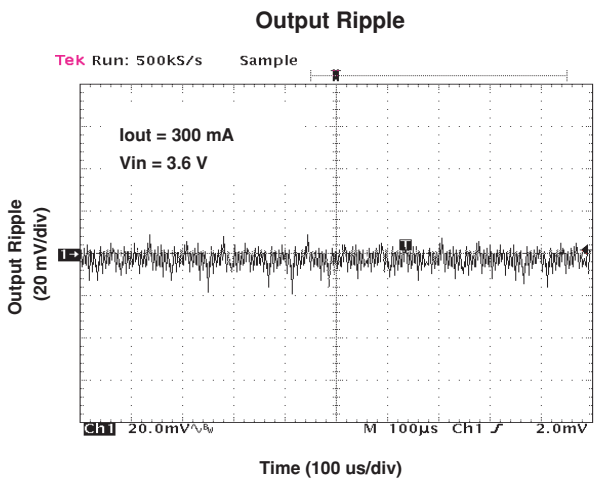
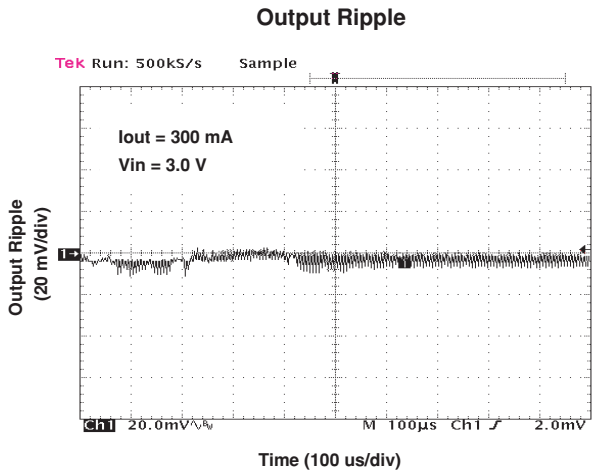
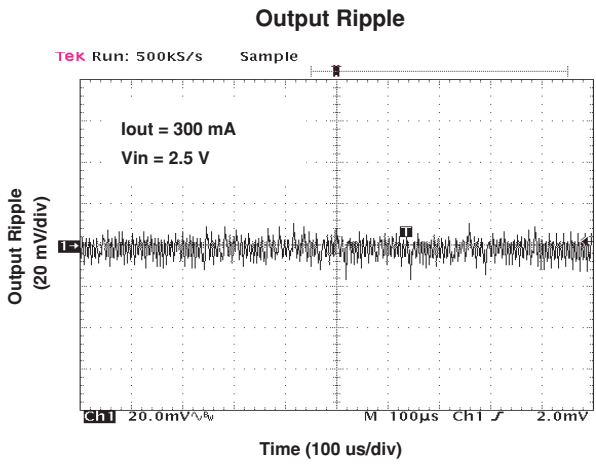
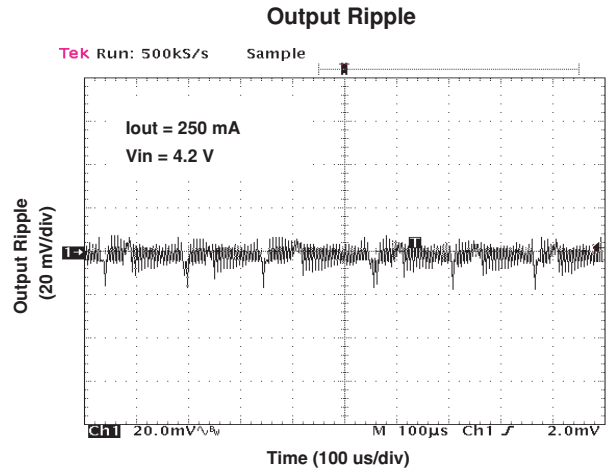
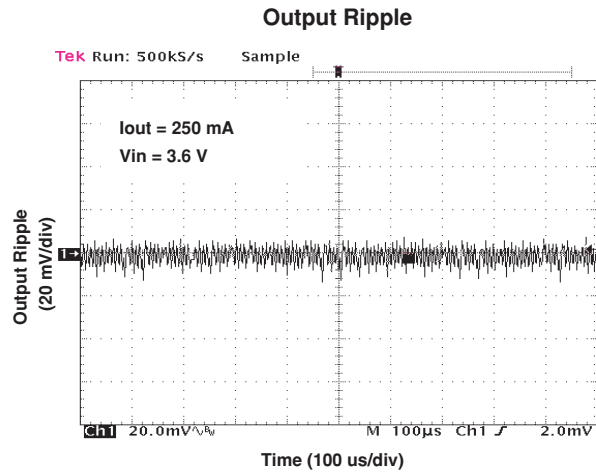

## Block Diagram

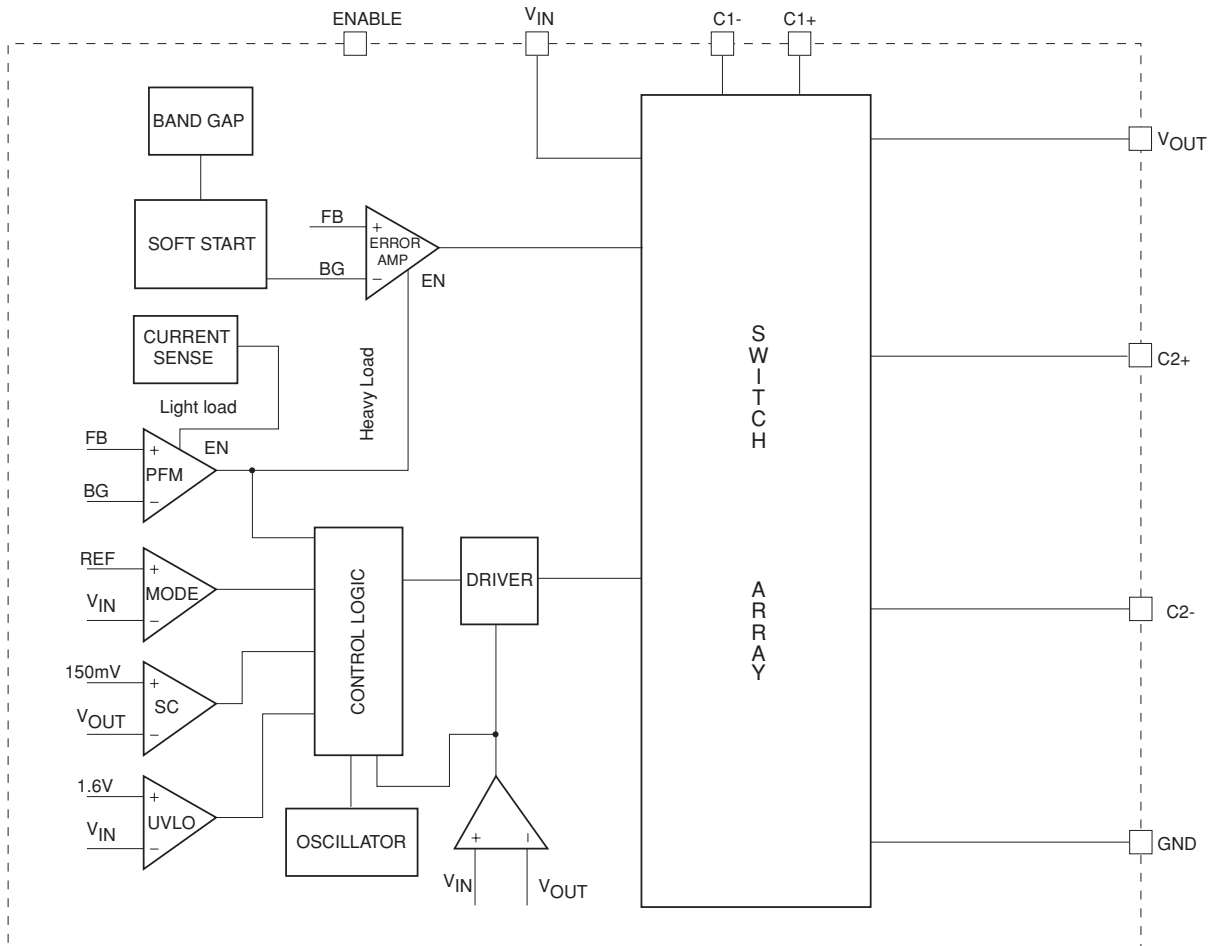

## Functional Description

FAN5602 is a high efficiency and low noise switched-capacitor DC/DC converter and is capable of both step-up and step-down operations. It has seven built-in switch configurations. Based on the ratio of the input voltage to the output voltage the FAN5602 automatically reconfigures the switches to achieve the highest efficiency. The regulation of the output is achieved by a linear regulation loop, which modulates the on-resistance of the power transistors so that the amount of charge transferred from the input to the flying capacitor at each clock cycle is controlled and is equal to the charge needed by the load. The current spike is reduced to minimum. At light load the FAN5602 automatically switches to PFM mode to save power. The regulation at PFM mode is achieved by skipping pulses.

## Linear Regulation Loop

The FAN5602 operates at constant frequency at load higher than 10mA. The linear regulation loop consisting of power transistors, feedback (resistor divider) and error amplifier is used to realize the regulation of the output voltage and to reduce the current spike. The error amplifier takes feedback and reference as inputs and generates the error voltage signal. The error voltage signal is then used as the gate voltage of the power transistor and modulates the on-resistance of the power transistor and therefore the charge transferred from the input to the output is controlled and the regulation of the output is realized. Since the charge transfer is controlled, the FAN5602 has small ESR spike.

# Switch Array

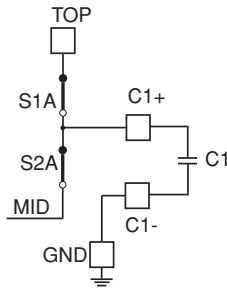

Figure. 1a  
Mode1(1:1)

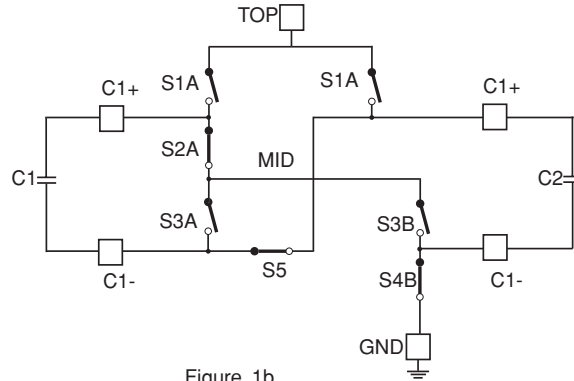

Figure. 1b  
Mode2 (2:3 or 3:2):  
All Switches set for phase 1  
and reverse state for phase 2

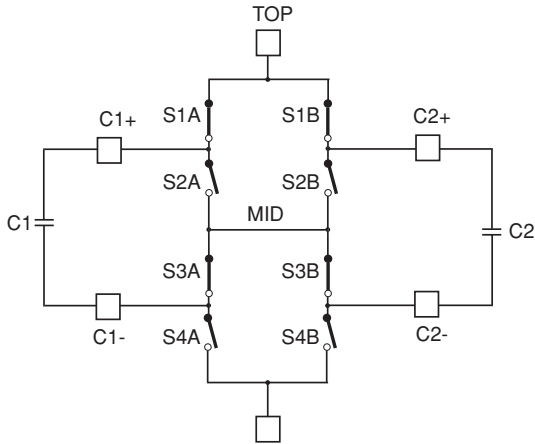

Figure. 1c  
Mode3 (1:2 or 2:1):  
All Switches set for phase 1  
and reverse state for phase 2

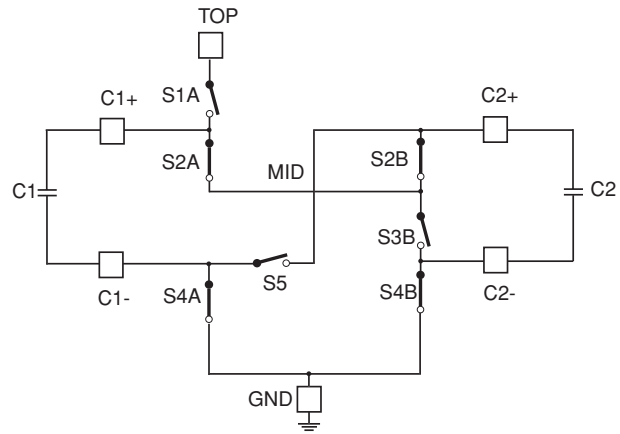

Figure. 1d  
Mode4 (1:3 or 3:1):  
All Switches set for phase 1  
and reverse state for phase 2

## Switch Configurations

The FAN5602 has seven built-in switch configurations including 1:1, 3:2, 2:1 and 3:1 for step-down and 2:3, 1:2 and 1:3 for step-up.

When  $1.5 \times V_{OUT} > V_{IN} > V_{OUT}$ , 1:1 mode shown in Fig. 1(a) is used. In this mode the internal oscillator is turned off. The power transistors connecting the input and the output become pass transistors and their gate voltages are controlled by the linear regulation loop, the rest of power transistors are turned off. In this mode the FAN5602 operates exactly like a low dropout (LDO) regulator and the ripple of the output is in the micro-volt range.

When  $1.5 \times V_{OUT} > V_{IN} > V_{OUT}$ , 2:3 mode (step-up) shown in Fig. 1(b) is used. In the charging phase two flying capacitors are placed in series and each capacitor is charged to a half of the input voltage. In pumping phase the flying capacitors are placed in parallel. The input is connected to the bottom of the capacitors so that the top of the capacitors is boosted to a voltage equals  $V_{IN}/2 + V_{IN}$ , i.e.,  $3/2 \times V_{IN}$ . By connecting the top of the capacitors to the output, one can ideally charge the output to  $3/2 \times V_{IN}$ . If  $3/2 \times V_{IN}$  is higher than the needed  $V_{OUT}$ , the linear regulation loop will adjust the on-resistance to drop some voltage. Boosting the voltage of the top of the capacitors to  $3/2 \times V_{IN}$  by connecting  $V_{IN}$  the bottom of the capacitors boosts the power efficiency 3/2 times. In 2:3 mode the ideal power efficiency is  $V_{OUT}/1.5 \times V_{IN}$  (For example, if  $V_{IN} = 2V$ ,  $V_{OUT} = 2 \times V_{IN} = 4V$ , the ideal power efficiency is 100%).

When  $2 \times V_{IN} > V_{OUT} > 1.5 \times V_{IN}$ , 1:2 mode (step-up) shown in Fig. 1(c) is used. Both in the charging phase and in pumping phase two flying capacitors are placed in parallel. In charging phase the capacitors are charged to the input voltage. In the pumping phase the input voltage is placed to the bottom the capacitors. The top of the capacitors is boosted to  $2 \times V_{IN}$ . By connecting the top of the capacitors to the output, one can ideally charge the output to  $2 \times V_{IN}$ . Boosting the voltage on the top of the capacitors to  $2V_{IN}$  boosts the power efficiency 2 times. In 1:2 mode the ideal power efficiency is  $V_{OUT}/2 \times V_{IN}$  (For example,  $V_{IN} = 2V$ ,  $V_{OUT} = 2 \times V_{IN} = 4V$ , the ideal power efficiency is 100%).

When  $3 \times V_{IN} > V_{OUT} > 2 \times V_{IN}$ , 1:3 mode (step-up) shown in Fig. 1(d) is used. In charging phase two flying capacitors are placed in parallel and each is charged to  $V_{IN}$ . In the pumping phase the two flying capacitors are placed in series and the input is connected to the bottom of the series connected capacitors. The top of the series connected capacitors is boosted to  $3 \times V_{IN}$ . The ideal power efficiency is boosted 3 times and is equal to  $V_{OUT}/3V_{IN}$  (For example,  $V_{IN} = 1V$ ,  $V_{OUT} = 3 \times V_{IN} = 3V$ , the ideal power efficiency is 100%). By connecting the output to the top of the series connected capacitors, one can charge the output to  $3 \times V_{IN}$ .

The internal logic in the FAN5602 monitors the input and the output and compares them and automatically selects the switch configuration to achieve the highest efficiency.

The step-down modes 3:2, 2:1 and 3:1 can be understood by reversing the function of  $V_{IN}$  and  $V_{OUT}$  in the above discussion.

The reason for built-in so many modes is to improve power efficiency and to extend the battery life. For example, if  $V_{OUT} = 5V$ , mode 1:2 needs a minimum  $V_{IN} = 2.5V$ . By built-in 1:3 mode, the minimum battery voltage is extended to 1.7V.

### Light Load Operation

The power transistors used in the charge pump are very large in size. The dynamic loss from the switching the power transistors is not small and increases its proportion of the total power consumption as the load gets light. To save power, the FAN5602 switches, when the load is less than 10mA, from

constant frequency to pulse-skipping mode (PFM) for modes 2:3(3:2), 1:2(2:1) and 1:3(3:1) except mode 1:1. In PFM mode the linear loop is disabled and the error amplifier is turned off. A PFM comparator is used to setup an upper threshold and a lower threshold for the output. When the output is lower than the lower threshold, the oscillator is turned on and the charge pump starts working and keeps delivering charges from the input to the output until the output is higher than the upper threshold. Then shut off the oscillator, shut off power transistors and deliver the charge to the output from the output capacitor. PFM operation is not used for Mode 1:1 even if at light load. Mode 1:1 in the FAN5602 is designed as a LDO with the oscillator off. The power transistors at LDO mode are not switching and therefore do not have the dynamic loss.

Switching from linear operation to PFM mode ( $I_{LOAD} < 10mA$ ) and from PFM to linear mode ( $I_{LOAD} > 10mA$ ) is automatic based on the load current, which is monitored all the time.

### Short Circuit

When the output voltage is lower than 150mV, the FAN5602 enters short circuit condition. In this condition all power transistors are turned off. A small transistor shorting the input and the output turns on and charges the output. This transistor keeps on as long as the  $V_{OUT} < 150mV$ . Since this transistor is very small, the current from the input to the output is limited. Once the short at the output is eliminated, this transistor is large enough to charge the output higher than 150mV and then the FAN5607 enters soft start period.

### Soft Start

The FAN5602 uses a constant current charging a low pass filter to generate a ramp. The ramp is used as reference voltage during the startup. Since the ramp starts at zero and goes up slowly, the output follows the ramp and therefore inrush current is restricted. When the ramp is higher than bandgap voltage, the bandgap voltage supersedes ramp as reference and the soft start is over. The soft start takes about 500 $\mu$ s.

### Thermal Shutdown

The FAN5602 will go to thermal shutdown if the junction temperature is over 150°C with 15°C hysteresis.

## Application Information

### Using the FAN5602 to drive LCD backlighting

The FAN5602 4.5 volt option is ideal for driving the backlighting and flash LEDs for any portable device. One FAN5602 device can supply the roughly 150 mA that are needed to power both the backlight and the flash LEDs. Even though drawing this much current from the FAN5602 will drive the part out of the 3% output regulation, it is not a

problem. The backlight and flash LEDs will still be able to produce optimal brightness at the reduced regulation. When building this circuit be sure to use ceramic capacitors with low ESR. Also all capacitors should be placed as close as possible to the FAN5602 in the PCB layout. Below is an example circuit for a backlighting / Flash application.

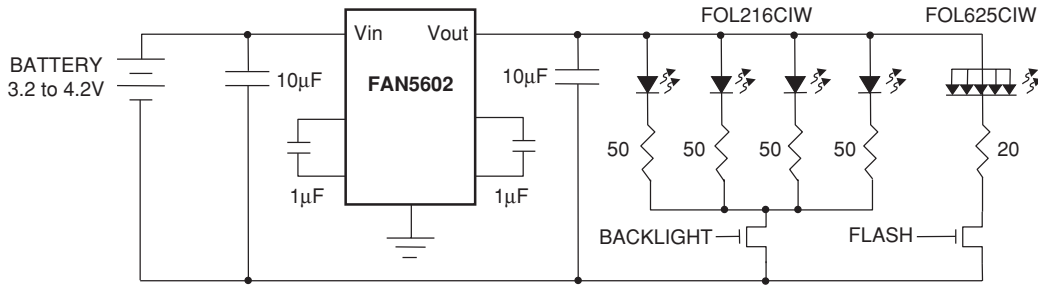
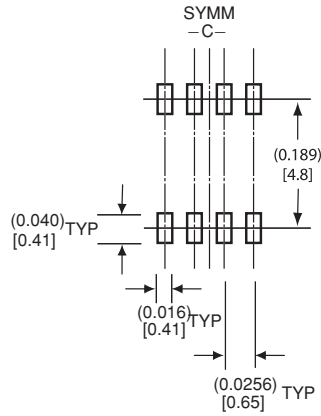
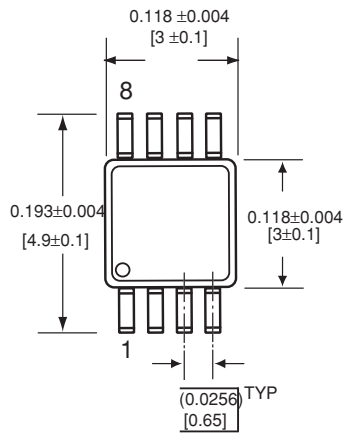

Figure 2.

# Mechanical Dimensions

## 8-Lead MSOP Package



PCB LAND PATTERN

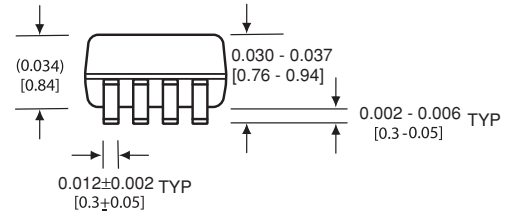
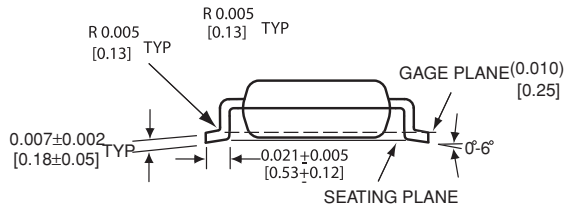

$\square$ -C-	$\square$ 0.002[0.05] C	$\oplus$	0.002[0.05] M	A/S	ES
---------------	-------------------------	----------	---------------	-----	----

msop8 package.EPS

# Mechanical Dimensions

## 3x3mm 8-Lead MLP Package

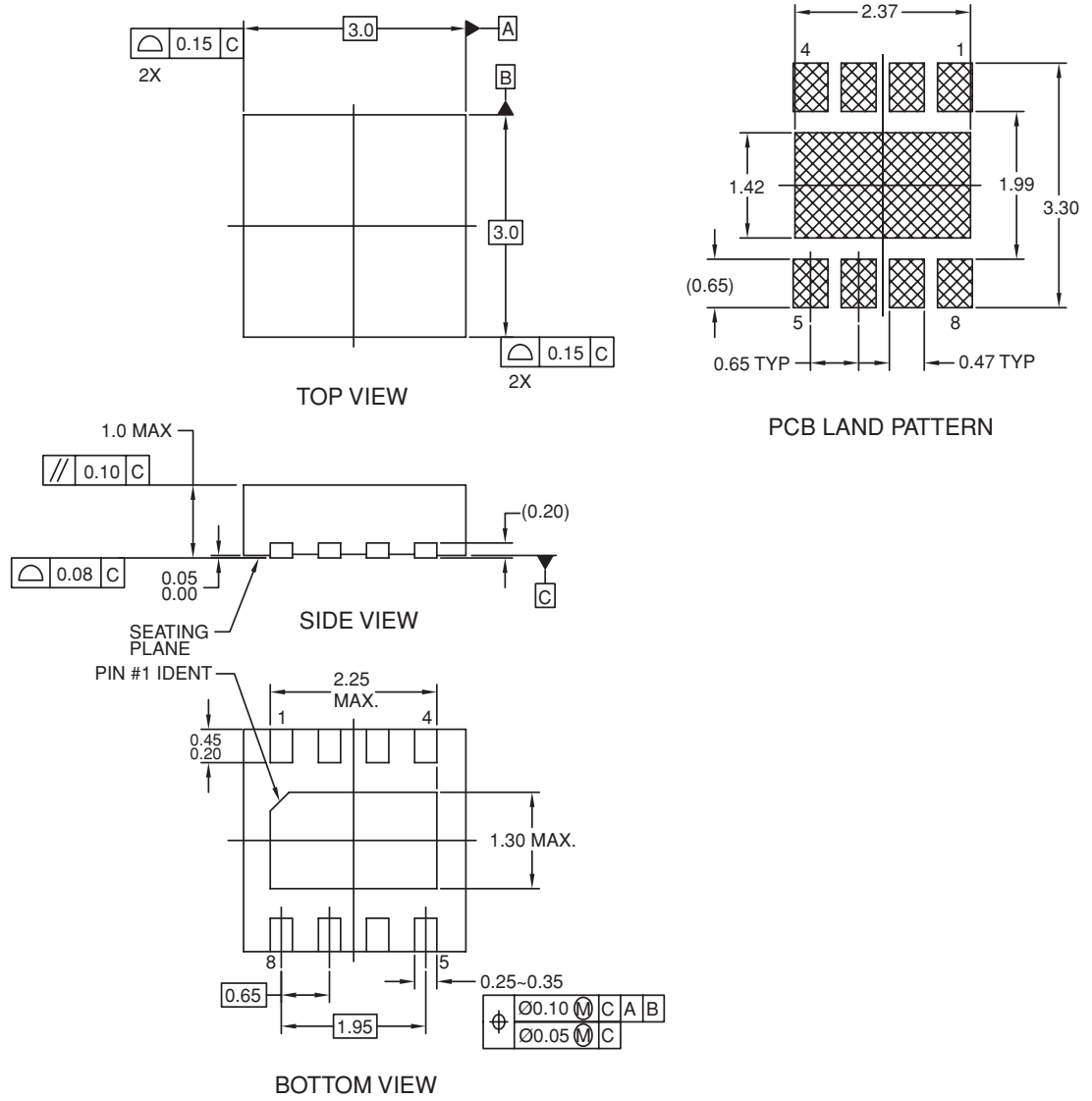

**NOTES:**

- A. CONFORMS TO JEDEC REGISTRATION MO-229, VARIATION VEEC, DATED 11/2001
- B. DIMENSIONS ARE IN MILLIMETERS.
- C. DIMENSIONS AND TOLERANCES PER ASME Y14.5M, 1994

## Ordering Information

Product Number	Package Type	Output Voltage, $V_{NOM}$	Order Code
FAN5602	8-Lead MSOP	3.3V	FAN5602MU33X
	3x3mm 8-Lead MLP	3.3V	FAN5602MP33X
	3x3mm 8-Lead MLP	4.5V	FAN5602MP45X
	3x3mm 8-Lead MLP	5.0V	FAN5602MP5X

### DISCLAIMER

FAIRCHILD SEMICONDUCTOR RESERVES THE RIGHT TO MAKE CHANGES WITHOUT FURTHER NOTICE TO ANY PRODUCTS HEREIN TO IMPROVE RELIABILITY, FUNCTION OR DESIGN. FAIRCHILD DOES NOT ASSUME ANY LIABILITY ARISING OUT OF THE APPLICATION OR USE OF ANY PRODUCT OR CIRCUIT DESCRIBED HEREIN; NEITHER DOES IT CONVEY ANY LICENSE UNDER ITS PATENT RIGHTS, NOR THE RIGHTS OF OTHERS.

### LIFE SUPPORT POLICY

FAIRCHILD'S PRODUCTS ARE NOT AUTHORIZED FOR USE AS CRITICAL COMPONENTS IN LIFE SUPPORT DEVICES OR SYSTEMS WITHOUT THE EXPRESS WRITTEN APPROVAL OF THE PRESIDENT OF FAIRCHILD SEMICONDUCTOR CORPORATION. As used herein:

1. Life support devices or systems are devices or systems which, (a) are intended for surgical implant into the body, or (b) support or sustain life, and (c) whose failure to perform when properly used in accordance with instructions for use provided in the labeling, can be reasonably expected to result in a significant injury of the user.
2. A critical component in any component of a life support device or system whose failure to perform can be reasonably expected to cause the failure of the life support device or system, or to affect its safety or effectiveness.