

General Description

The AAT1141 SwitchReg is a 2MHz step-down converter with an input voltage range of 2.7V to 5.5V and output voltage as low as 0.6V. It is optimized to react quickly to a load variation.

The AAT1141 is available in fixed voltage versions with internal feedback and a programmable version with external feedback resistors. It can deliver 600mA of load current while maintaining a low 35µA no load quiescent current. The 2MHz switching frequency minimizes the size of external components while keeping switching losses low.

The AAT1141 is designed to maintain high efficiency throughout the operating range, which is critical for portable applications.

The AAT1141 is available in a Pb-free SOT23-5 package and is rated over the -40°C to +85°C temperature range.

Features

- V_{IN} Range: 2.7V to 5.5V
- V_{OUT} Fixed or Adjustable from 0.6V to V_{IN}
- 35µA No Load Quiescent Current
- Up to 98% Efficiency
- 600mA Max Output Current
- 2MHz Switching Frequency
- 150µs Soft Start
- Fast Load Transient
- Over-Temperature Protection
- Current Limit Protection
- 100% Duty Cycle Low-Dropout Operation
- <1µA Shutdown Current
- SOT23-5 Package
- Temperature Range: -40°C to +85°C

Applications

- Cellular Phones
- Digital Cameras
- Handheld Instruments
- Microprocessor / DSP Core / IO Power
- PDAs and Handheld Computers
- USB Devices

Typical Application (Fixed Output Voltage)

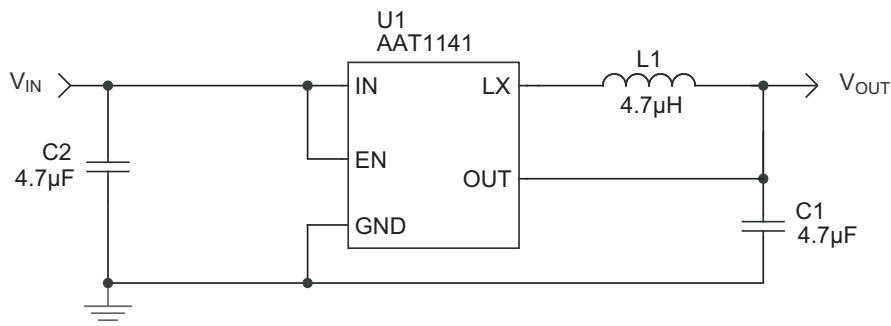

Pin Descriptions

Pin #	Symbol	Function
1	IN	Input supply voltage for the converter.
2	GND	Ground pin. Connect to the output and input capacitor return.
3	EN	Enable pin.
4	OUT	Feedback input pin. This pin is connected either directly to the converter output or to an external resistive divider for an adjustable output.
5	LX	Switching node. Connect the inductor to this pin. It is internally connected to the drains of both high- and low-side MOSFETs.

Pin Configuration

**SOT23-5
(Top View)**

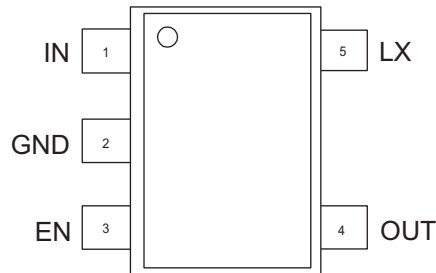

Absolute Maximum Ratings¹

Symbol	Description	Value	Units
V _{IN}	Input Voltage to GND	6.0	V
V _{LX}	LX to GND	-0.3 to V _{IN} + 0.3	V
V _{OUT}	OUT to GND	-0.3 to V _{IN} + 0.3	V
V _{EN}	EN to GND	-0.3 to 6.0	V
T _J	Operating Junction Temperature Range	-40 to 150	°C
T _S	Storage Temperature Range	-65 to 150	°C
T _{LEAD}	Maximum Soldering Temperature (at leads, 10 sec)	300	°C

Thermal Information

Symbol	Description	Value	Units
P _D	Maximum Power Dissipation ^{2, 3}	667	mW
θ _{JA}	Thermal Resistance ²	150	°C/W

1. Stresses above those listed in Absolute Maximum Ratings may cause permanent damage to the device. Functional operation at conditions other than the operating conditions specified is not implied. Only one Absolute Maximum Rating should be applied at any one time.

2. Mounted on an FR4 board.

3. Derate 6.67mW/°C above 25°C.

Electrical Characteristics¹

$T_A = -40^\circ\text{C}$ to $+85^\circ\text{C}$, unless otherwise noted. Typical values are $T_A = 25^\circ\text{C}$, $V_{IN} = 3.6\text{V}$.

Symbol	Description	Conditions	Min	Typ	Max	Units
Step-Down Converter						
V_{IN}	Input Voltage		2.7		5.5	V
V_{UVLO}	UVLO Threshold	V_{IN} Rising			2.7	V
		Hysteresis		100		mV
		V_{IN} Falling	1.8			V
V_{OUT}	Output Voltage Tolerance	$I_{OUT} = 0$ to 600mA , $V_{IN} = 2.7\text{V}$ to 5.5V	-3.5		+3.5	%
V_{OUT}	Output Voltage Range		0.6		V_{IN}	V
I_Q	Quiescent Current	No Load, 0.6V Adjustable Version		35	70	μA
I_{SHDN}	Shutdown Current	EN = AGND = PGND			1.0	μA
I_{LIM}	P-Channel Current Limit		800			mA
$R_{DS(ON)H}$	High Side Switch On Resistance			0.35		Ω
$R_{DS(ON)L}$	Low Side Switch On Resistance			0.30		Ω
I_{LXLEAK}	LX Leakage Current	$V_{IN} = 5.5\text{V}$, $V_{LX} = 0$ to V_{IN} , EN = GND			1	μA
$\Delta V_{Linereg}$	Line Regulation	$V_{IN} = 2.7\text{V}$ to 5.5V		0.1		%/V
V_{OUT}	Out Threshold Voltage Accuracy	0.6V Output, No Load, $T_A = 25^\circ\text{C}$	588	600	612	mV
I_{OUT}	Out Leakage Current	0.6V Output			0.2	μA
R_{OUT}	Out Impedance	>0.6V Output	250			$\text{k}\Omega$
T_S	Start-Up Time	From Enable to Output Regulation		150		μs
F_{OSC}	Oscillator Frequency	$T_A = 25^\circ\text{C}$	1.2	2.0	2.6	MHz
T_{SD}	Over-Temperature Shutdown Threshold			140		$^\circ\text{C}$
T_{HYS}	Over-Temperature Shutdown Hysteresis			15		$^\circ\text{C}$
EN						
$V_{EN(L)}$	Enable Threshold Low				0.6	V
$V_{EN(H)}$	Enable Threshold High		1.4			V
I_{EN}	Input Low Current	$V_{IN} = V_{OUT} = 5.5\text{V}$	-1.0		1.0	μA

1. The AAT1141 is guaranteed to meet performance specifications over the -40°C to $+85^\circ\text{C}$ operating temperature range and is assured by design, characterization, and correlation with statistical process controls.

Typical Characteristics

Efficiency vs. Load
($V_{OUT} = 3.3V$; $L = 6.8\mu H$)

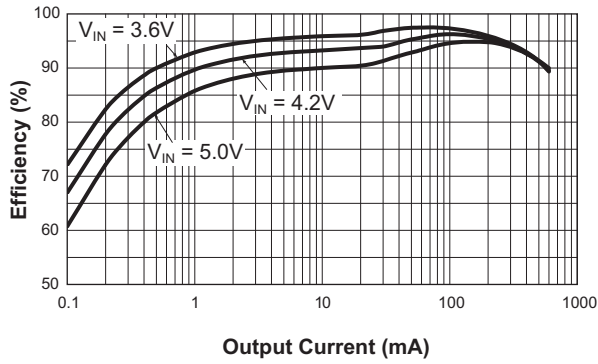

DC Regulation
($V_{OUT} = 3.3V$; $L = 6.8\mu H$)

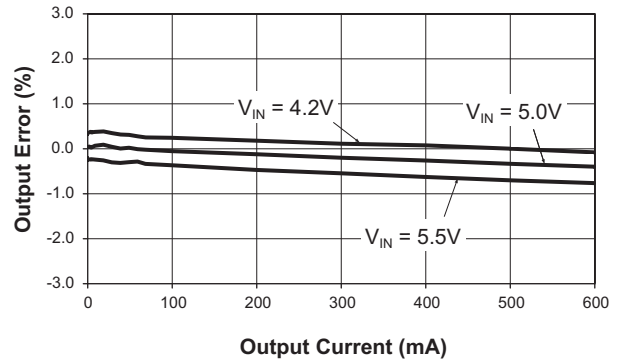

Efficiency vs. Load
($V_{OUT} = 2.5V$; $L = 6.8\mu H$)

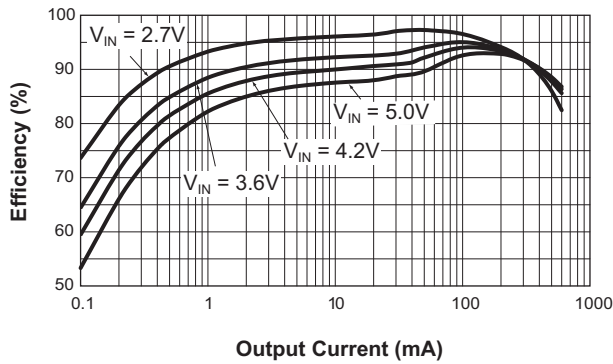

DC Regulation
($V_{OUT} = 2.5V$; $L = 6.8\mu H$)

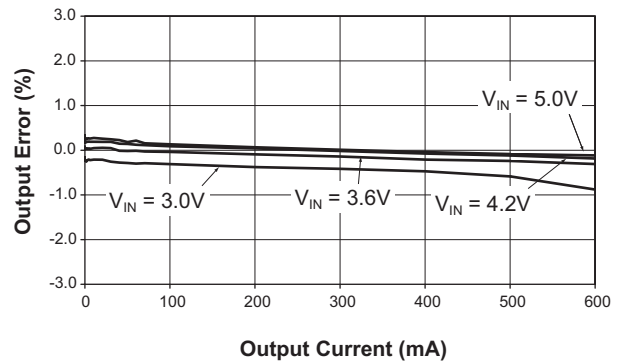

Efficiency vs. Load
($V_{OUT} = 1.8V$; $L = 4.7\mu H$)

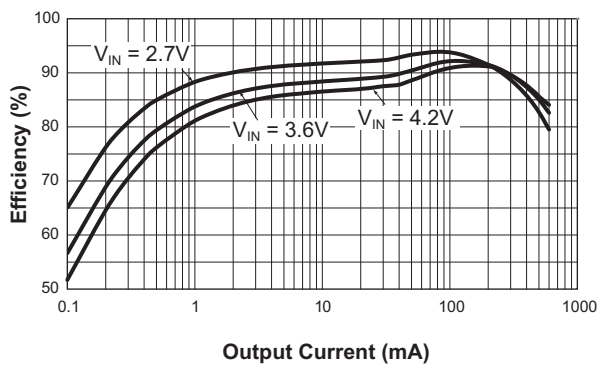

DC Regulation
($V_{OUT} = 1.8V$; $L = 4.7\mu H$)

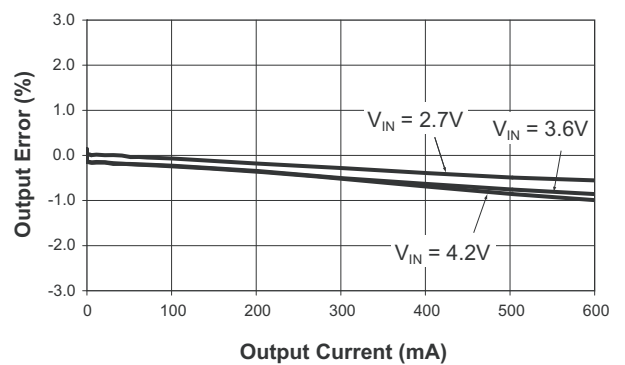

Typical Characteristics

Soft Start

($V_{IN} = 3.6V$; $V_{OUT} = 1.8V$; Load = 3Ω ; $C_{FF} = 100pF$)

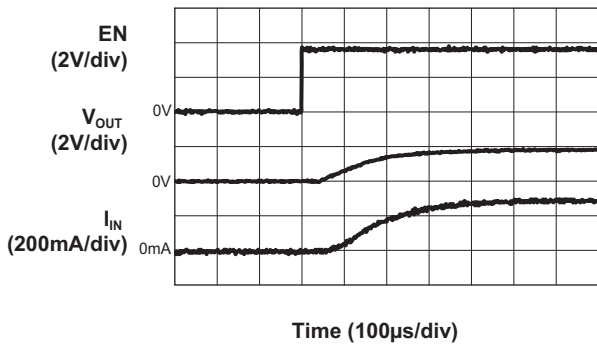

Line Regulation

($V_{OUT} = 1.8V$)

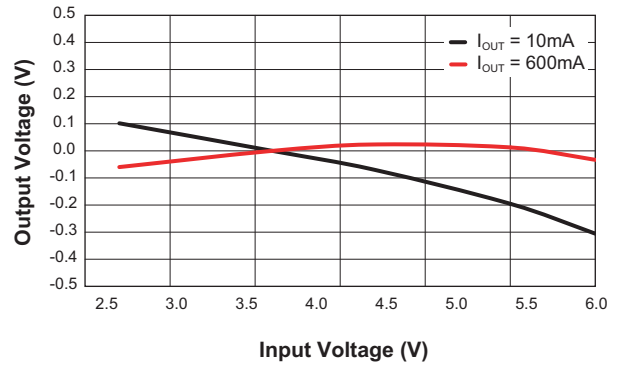

Output Voltage Error vs. Temperature

($V_{IN} = 3.6V$; $V_O = 1.8V$; $I_{OUT} = 400mA$)

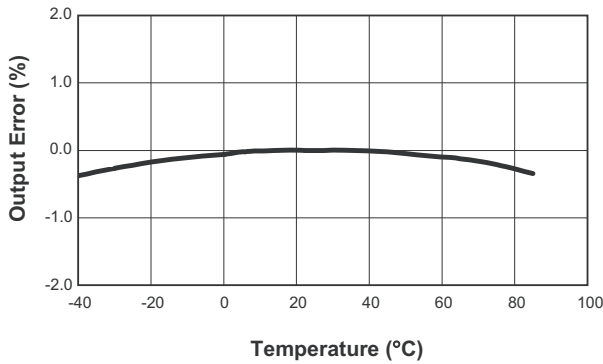

Switching Frequency vs. Temperature

($V_{IN} = 3.6V$; $V_{OUT} = 1.8V$)

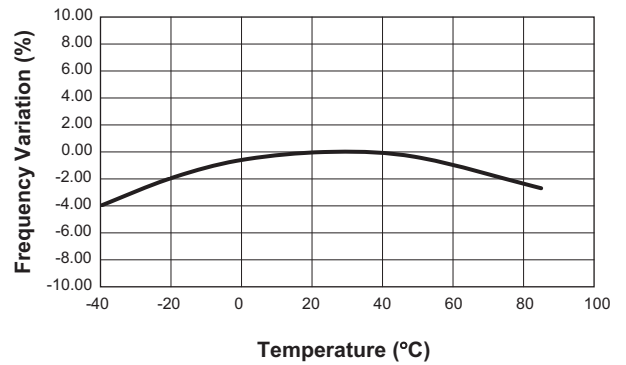

Frequency vs. Input Voltage

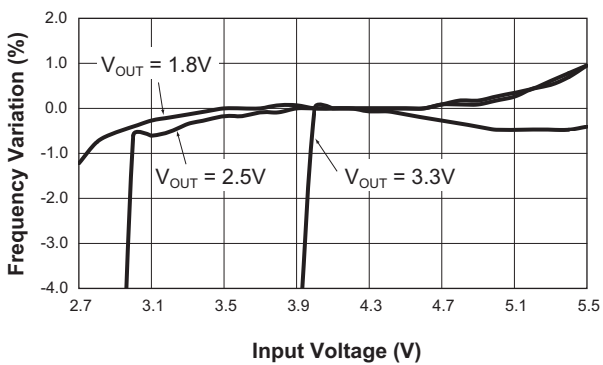

No Load Quiescent Current vs. Input Voltage

($V_{OUT} = 3.0V$, $L = 6.8\mu H$)

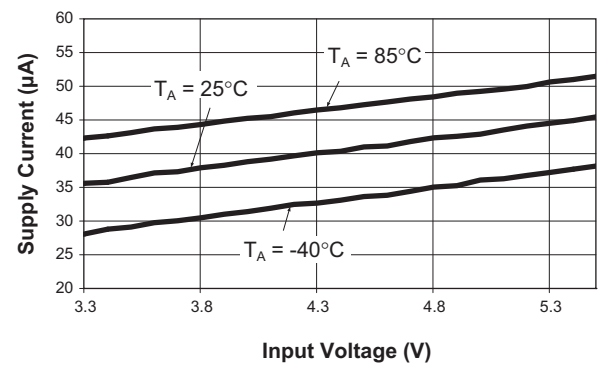

Typical Characteristics

No Load Quiescent Current vs. Input Voltage
($V_{OUT} = 1.8V$, $L = 4.7\mu H$)

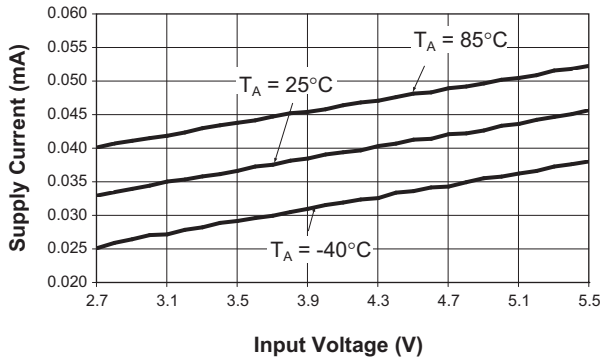

No Load Quiescent Current vs. Input Voltage
($V_{OUT} = 1.2V$, $L = 2.2\mu H$)

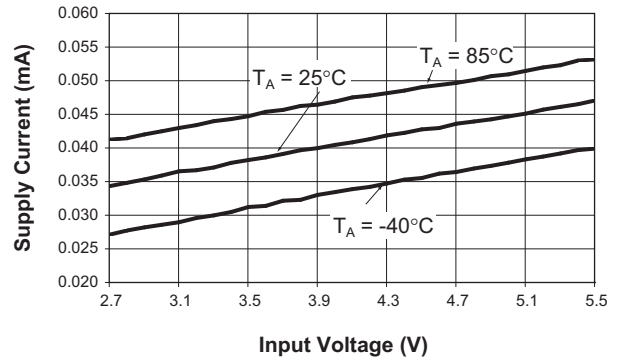

P-Channel $R_{DS(ON)}$ vs. Input Voltage

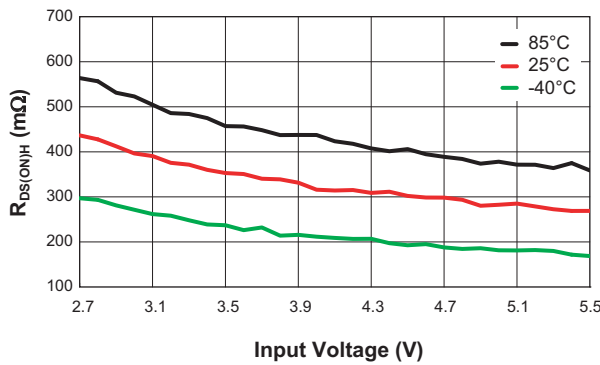

N-Channel $R_{DS(ON)}$ vs. Input Voltage

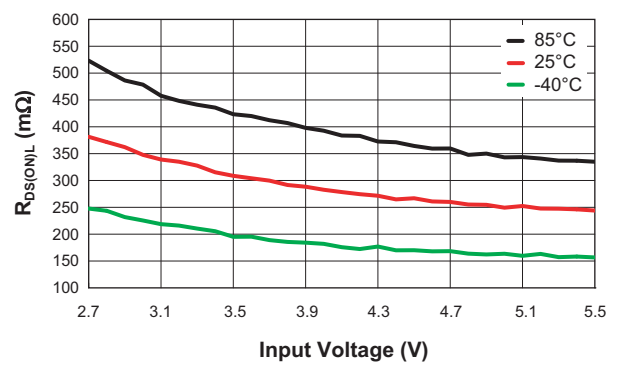

Step-Down Converter Load Transient Response
(1mA to 300mA; $V_{IN} = 3.6V$; $V_{OUT} = 1.8V$;
 $C_{OUT} = 4.7\mu F$; $C_{FF} = 100pF$)

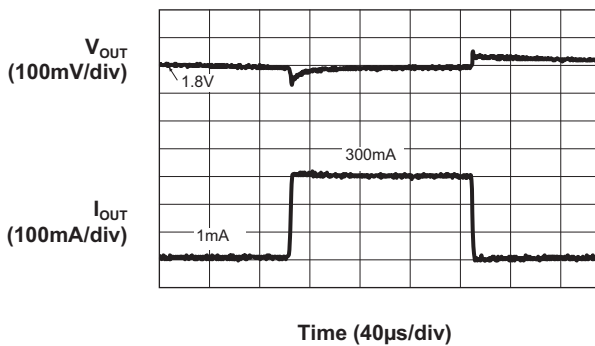

Step-Down Converter Load Transient Response
(300mA to 400mA; $V_{IN} = 3.6V$;
 $V_{OUT} = 1.8V$; $C_{OUT} = 4.7\mu F$; $C_{FF} = 100pF$)

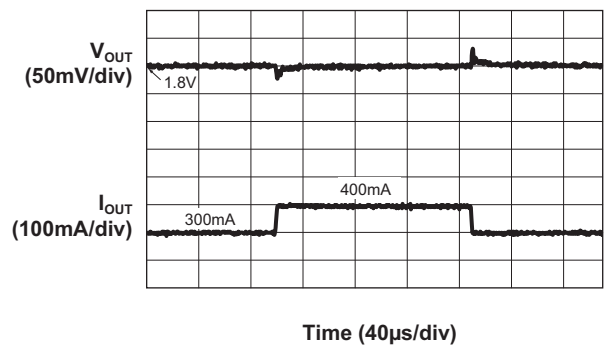

Typical Characteristics

Step-Down Converter Load Transient Response
 (1mA to 300mA; $V_{IN} = 3.6V$; $V_{OUT} = 1.0V$;
 $C_{OUT} = 10\mu F$; $C_{FF} = 0pF$)

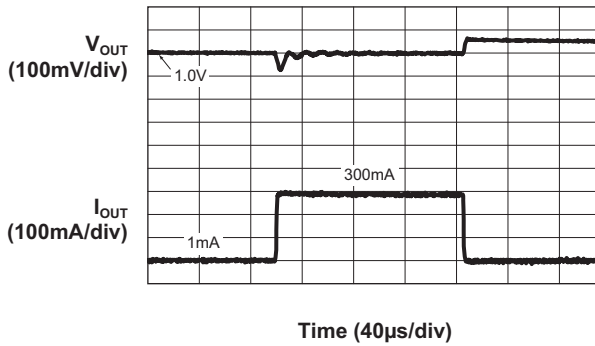

Step-Down Converter Load Transient Response
 (300mA to 400mA; $V_{IN} = 3.6V$;
 $V_{OUT} = 1.0V$; $C_{OUT} = 10\mu F$; $C_{FF} = 0pF$)

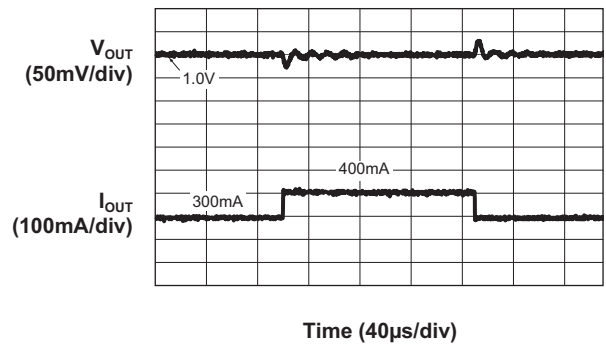

Line Response
 ($V_{OUT} = 1.8V$ @ 400mA)

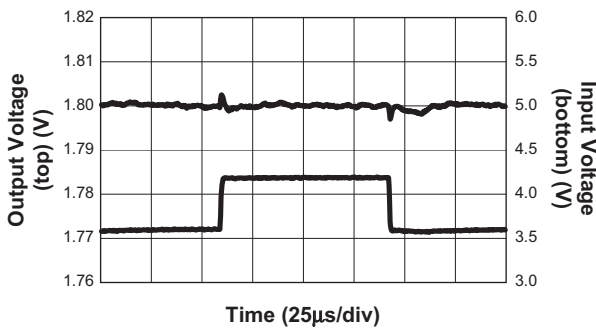

Step-Down Converter Output Ripple
 ($V_{OUT} = 1.8V$; $V_{IN} = 3.6V$; $I_{OUT} = 1mA$; $L = 4.7\mu H$;
 $C_{FF} = 100pF$; $C_{OUT} = 4.7\mu F$)

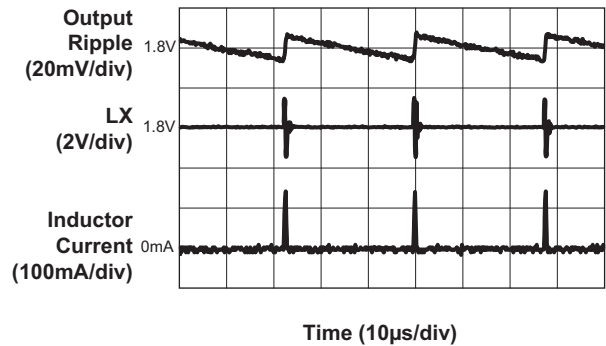

Step-Down Converter Output Ripple
 ($V_{OUT} = 1.8V$; $V_{IN} = 3.6V$; $I_{OUT} = 600mA$;
 $L = 4.7\mu H$; $C_{FF} = 100pF$; $C_{OUT} = 4.7\mu F$)

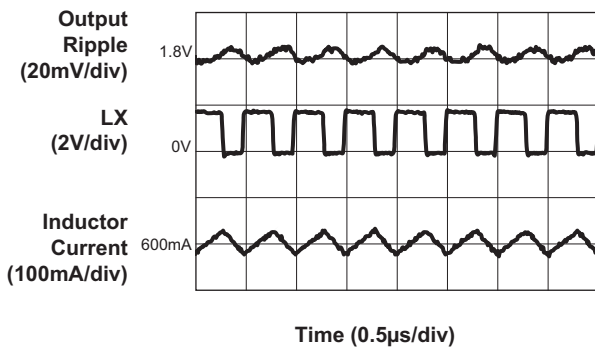

Functional Block Diagram

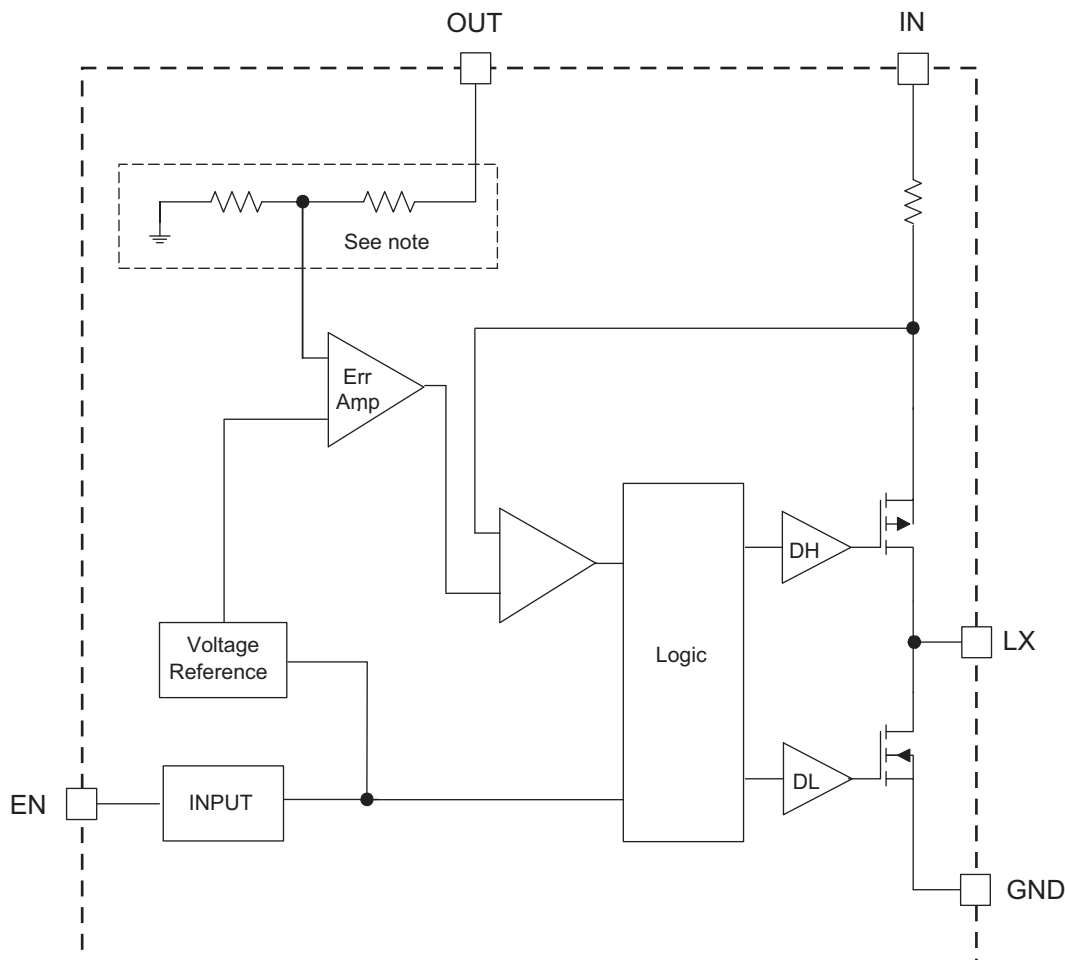

Note: For adjustable version, the internal feedback divider is omitted and the OUT pin is tied directly to the internal error amplifier.

Functional Description

The AAT1141 is a high performance 600mA 2MHz monolithic step-down converter. It has been designed with the goal of minimizing external component size and optimizing efficiency over the complete load range. Apart from the small bypass input capacitor, only a small L-C filter is required at the output. Typically, a 4.7µH inductor and a 4.7µF ceramic capacitor are recommended (see table of values).

The fixed output version requires only three external power components (C_{IN} , C_{OUT} , and L). The adjustable version can be programmed with external feedback to any voltage, ranging from 0.6V to the input voltage. An addi-

tional feed-forward capacitor can also be added to the external feedback to provide improved transient response (see Figure 1).

At dropout, the converter duty cycle increases to 100% and the output voltage tracks the input voltage minus the $R_{DS(ON)}$ drop of the P-channel high-side MOSFET.

The input voltage range is 2.7V to 5.5V. The converter efficiency has been optimized for all load conditions, ranging from no load to 600mA.

The internal error amplifier and compensation provides excellent transient response, load, and line regulation. Soft start eliminates any output voltage overshoot when the enable or the input voltage is applied.

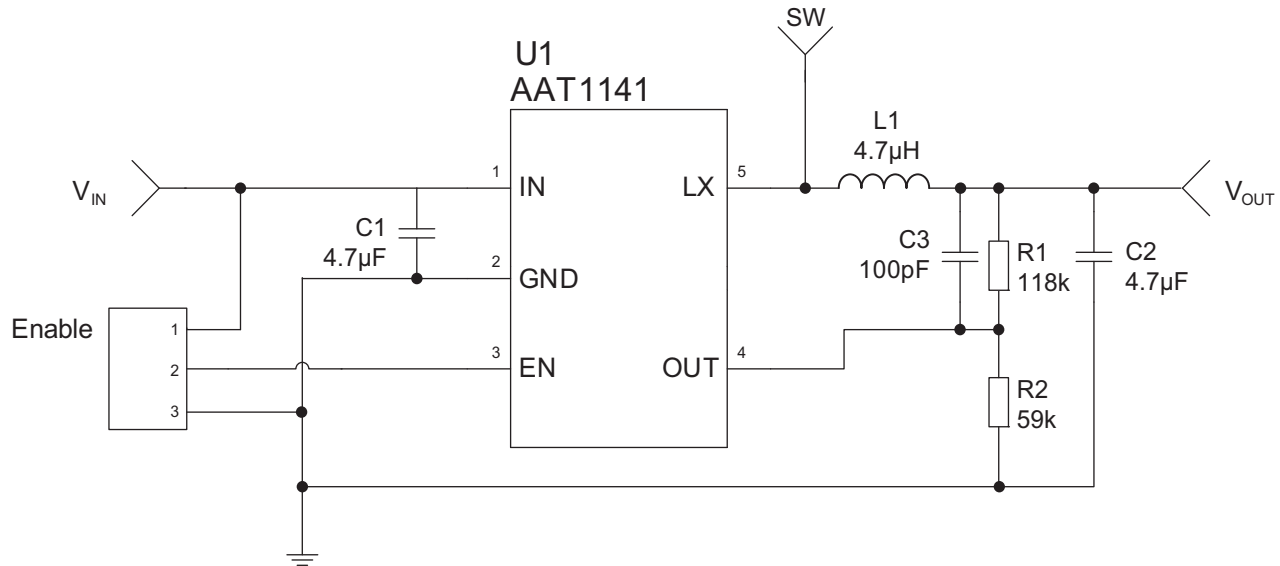

Figure 1: Enhanced Transient Response Schematic.

Control Loop

The AAT1141 is a peak current mode step-down converter. The current through the P-channel MOSFET (high side) is sensed for current loop control, as well as short circuit and overload protection. A fixed slope compensation signal is added to the sensed current to maintain stability for duty cycles greater than 50%. The peak current mode loop appears as a voltage-programmed current source in parallel with the output capacitor.

The output of the voltage error amplifier programs the current mode loop for the necessary peak switch current to force a constant output voltage for all load and line conditions. Internal loop compensation terminates the transconductance voltage error amplifier output. For fixed voltage versions, the error amplifier reference voltage is internally set to program the converter output voltage. For the adjustable output, the error amplifier reference is fixed at 0.6V.

Soft Start / Enable

Soft start limits the current surge seen at the input and eliminates output voltage overshoot. When pulled low, the enable input forces the AAT1141 into a low-power, non-switching state. The total input current during shutdown is less than 1µA.

Current Limit and Over-Temperature Protection

For overload conditions, the peak input current is limited. To minimize power dissipation and stresses under current limit and short-circuit conditions, switching is terminated after entering current limit for a series of pulses. Switching is terminated for seven consecutive clock cycles after a current limit has been sensed for a series of four consecutive clock cycles.

Thermal protection completely disables switching when internal dissipation becomes excessive. The junction over-temperature threshold is 140°C with 15°C of hysteresis. Once an over-temperature or over-current fault condition is removed, the output voltage automatically recovers.

Under-Voltage Lockout

Internal bias of all circuits is controlled via the IN input. Under-voltage lockout (UVLO) guarantees sufficient V_{IN} bias and proper operation of all internal circuitry prior to activation.

Applications Information

Inductor Selection

The step-down converter uses peak current mode control with slope compensation to maintain stability for duty cycles greater than 50%. The output inductor value must be selected so the inductor current down slope meets the internal slope compensation requirements. The internal slope compensation for the adjustable and low-voltage fixed versions of the AAT1141 is 0.24A/μsec. This equates to a slope compensation that is 75% of the inductor current down slope for a 1.5V output and 4.7μH inductor.

$$m = \frac{0.75 \cdot V_o}{L} = \frac{0.75 \cdot 1.5V}{4.7\mu H} = 0.24 \frac{A}{\mu s}$$

This is the internal slope compensation for the adjustable (0.6V) version or low-voltage fixed versions. When externally programming the 0.6V version to 2.5V, the calculated inductance is 7.5μH.

$$L = \frac{0.75 \cdot V_o}{m} = \frac{0.75 \cdot V_o}{0.24 \frac{A}{\mu s}} \approx 3 \frac{\mu s}{A} \cdot V_o$$

$$= 3 \frac{\mu s}{A} \cdot 2.5V = 7.5\mu H$$

In this case, a standard 6.8μH value is selected.

For high-voltage fixed versions ($\geq 2.5V$), $m = 0.48A/\mu sec$. Table 1 displays inductor values for the AAT1141 fixed and adjustable options.

Manufacturer's specifications list both the inductor DC current rating, which is a thermal limitation, and the peak current rating, which is determined by the saturation characteristics. The inductor should not show any appreciable saturation under normal load conditions. Some inductors may meet the peak and average current ratings yet result in excessive losses due to a high DCR. Always consider the losses associated with the DCR and its effect on the total converter efficiency when selecting an inductor.

Output Voltage (V)	Inductor (μH)	Output Capacitor (μF)
1, 1.2	2.2	10
1.5, 1.8	4.7	4.7
2.5, 3.3	6.8	4.7

Table 1: Inductor and Output Capacitor Values.

The 4.7μH CDRH2D14 series inductor selected from Sumida has a 135mΩ typical DCR and a 1A DC current rating. At full load, the inductor DC loss is 48mW which gives a 4.5% loss in efficiency for a 600mA, 1.8V output.

Input Capacitor

Select a 4.7μF to 10μF X7R or X5R ceramic capacitor for the input. To estimate the required input capacitor size, determine the acceptable input ripple level (V_{PP}) and solve for C. The calculated value varies with input voltage and is a maximum when V_{IN} is double the output voltage.

$$C_{IN} = \frac{\frac{V_o}{V_{IN}} \cdot \left(1 - \frac{V_o}{V_{IN}}\right)}{\left(\frac{V_{PP}}{I_o} - ESR\right) \cdot F_s}$$

$$\frac{V_o}{V_{IN}} \cdot \left(1 - \frac{V_o}{V_{IN}}\right) = \frac{1}{4} \text{ for } V_{IN} = 2 \cdot V_o$$

$$C_{IN(MIN)} = \frac{1}{\left(\frac{V_{PP}}{I_o} - ESR\right) \cdot 4 \cdot F_s}$$

Always examine the ceramic capacitor DC voltage coefficient characteristics when selecting the proper value. For example, the capacitance of a 10μF, 6.3V, X5R ceramic capacitor with 5.0V DC applied is actually about 6μF.

The maximum input capacitor RMS current is:

$$I_{RMS} = I_o \cdot \sqrt{\frac{V_o}{V_{IN}} \cdot \left(1 - \frac{V_o}{V_{IN}}\right)}$$

The input capacitor RMS ripple current varies with the input and output voltage and will always be less than or equal to half of the total DC load current.

$$\sqrt{\frac{V_o}{V_{IN}} \cdot \left(1 - \frac{V_o}{V_{IN}}\right)} = \sqrt{D \cdot (1 - D)} = \sqrt{0.5^2} = \frac{1}{2}$$

for $V_{IN} = 2 \cdot V_o$

$$I_{RMS(MAX)} = \frac{I_o}{2}$$

The term $\frac{V_o}{V_{IN}} \cdot \left(1 - \frac{V_o}{V_{IN}}\right)$ appears in both the input voltage ripple and input capacitor RMS current equations and is a maximum when V_o is twice V_{IN} . This is why the input voltage ripple and the input capacitor RMS current ripple are a maximum at 50% duty cycle.

The input capacitor provides a low impedance loop for the edges of pulsed current drawn by the AAT1141. Low ESR/ESL X7R and X5R ceramic capacitors are ideal for this function. To minimize stray inductance, the capacitor should be placed as closely as possible to the IC. This keeps the high frequency content of the input current localized, minimizing EMI and input voltage ripple.

The proper placement of the input capacitor (C2) can be seen in the evaluation board layout in Figure 2.

A laboratory test set-up typically consists of two long wires running from the bench power supply to the evaluation board input voltage pins. The inductance of these wires, along with the low-ESR ceramic input capacitor, can create a high Q network that may affect converter performance. This problem often becomes apparent in the form of excessive ringing in the output voltage during load transients. Errors in the loop phase and gain measurements can also result.

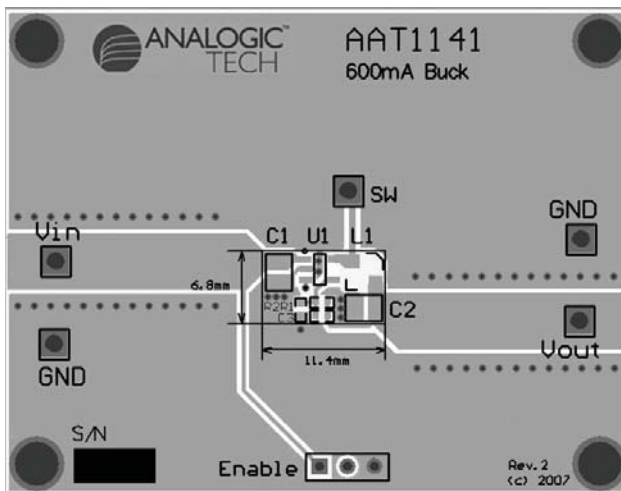

Figure 2: AAT1141 Sample Layout Top Side.

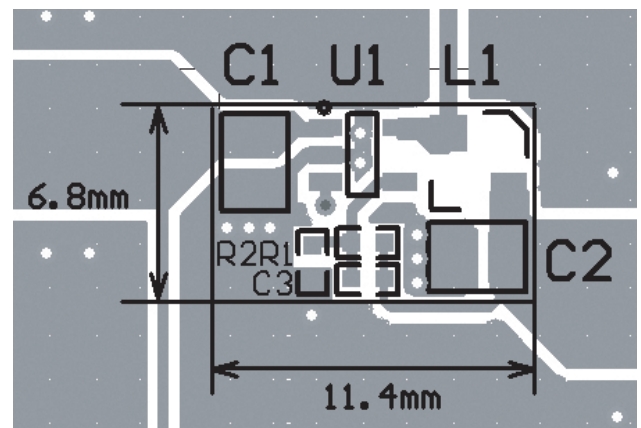

Figure 3: Exploded View of Sample Layout.

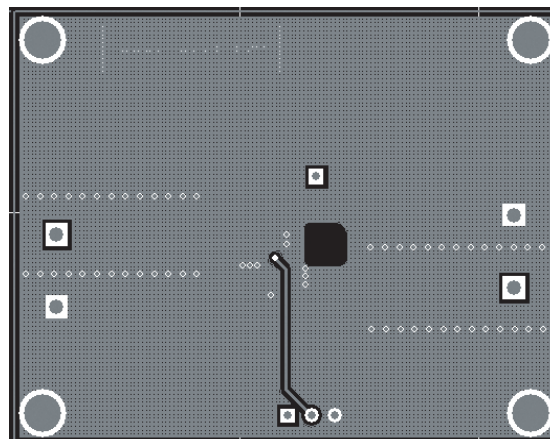

Figure 4: AAT1141 Sample Layout Bottom Side.

Since the inductance of a short PCB trace feeding the input voltage is significantly lower than the power leads from the bench power supply, most applications do not exhibit this problem.

In applications where the input power source lead inductance cannot be reduced to a level that does not affect the converter performance, a high ESR tantalum or aluminum electrolytic should be placed in parallel with the low ESR, ESL bypass ceramic. This dampens the high Q network and stabilizes the system.

Output Capacitor

The output capacitor limits the output ripple and provides holdup during large load transitions. A 4.7µF to 10µF X5R or X7R ceramic capacitor typically provides sufficient bulk capacitance to stabilize the output during large load transitions and has the ESR and ESL characteristics necessary for low output ripple.

The output voltage droop due to a load transient is dominated by the capacitance of the ceramic output capacitor. During a step increase in load current, the ceramic output capacitor alone supplies the load current until the loop responds. Within two or three switching cycles, the loop responds and the inductor current increases to match the load current demand. The relationship of the output voltage droop during the three switching cycles to the output capacitance can be estimated by:

$$C_{OUT} = \frac{3 \cdot \Delta I_{LOAD}}{V_{DROOP} \cdot F_S}$$

Once the average inductor current increases to the DC load level, the output voltage recovers. The above equation establishes a limit on the minimum value for the output capacitor with respect to load transients.

The internal voltage loop compensation also limits the minimum output capacitor value to 4.7µF. This is due to its effect on the loop crossover frequency (bandwidth), phase margin, and gain margin. Increased output capacitance will reduce the crossover frequency with greater phase margin.

The maximum output capacitor RMS ripple current is given by:

$$I_{RMS(MAX)} = \frac{1}{2 \cdot \sqrt{3}} \cdot \frac{V_{OUT} \cdot (V_{IN(MAX)} - V_{OUT})}{L \cdot F \cdot V_{IN(MAX)}}$$

Dissipation due to the RMS current in the ceramic output capacitor ESR is typically minimal, resulting in less than a few degrees rise in hot-spot temperature.

Adjustable Output Resistor Selection

For applications requiring an adjustable output voltage, the 0.6V version can be externally programmed. Resistors R1 and R2 of Figure 5 program the output to regulate at a voltage higher than 0.6V. To limit the bias current required for the external feedback resistor string while maintaining good noise immunity, the minimum suggested value for R2 is 59kΩ. Although a larger value will further reduce quiescent current, it will also increase the impedance of the feedback node, making it more sensitive to external noise and interference. Table 2 summarizes the resistor values for various output voltages with R2 set to either 59kΩ for good noise immunity or 316kΩ for reduced no load input current.

$$R1 = \left(\frac{V_{OUT}}{V_{REF}} - 1 \right) \cdot R2 = \left(\frac{1.5V}{0.6V} - 1 \right) \cdot 59k\Omega = 88.5k\Omega$$

The adjustable version of the AAT1141, combined with an external feedforward capacitor (C3 in Figure 1), delivers enhanced transient response for extreme pulsed load applications. The addition of the feedforward capacitor typically requires a larger output capacitor C1 for stability.

V _{OUT} (V)	High Noise Immunity R2 = 59kΩ R1 (kΩ)	Low Input Current (Without Load) R2 = 316kΩ R1 (kΩ)
0.8	19.6	105
0.9	29.4	158
1.0	39.2	210
1.1	49.9	267
1.2	59.0	316
1.3	68.1	365
1.4	78.7	422
1.5	88.7	475
1.8	88.7	634
2.0	137	732
2.5	187	1000
3.0	237	1270
3.3	267	1430

Table 2: Adjustable Resistor Values For Use With 0.6V Step-Down Converter.

Thermal Calculations

There are three types of losses associated with the AAT1141 step-down converter: switching losses, conduction losses, and quiescent current losses. Conduction losses are associated with the $R_{DS(ON)}$ characteristics of the power output switching devices. Switching losses are dominated by the gate charge of the power output switching devices. At full load, assuming continuous conduction mode (CCM), a simplified form of the LDO losses is given by:

$$P_{TOTAL} = \frac{I_o^2 \cdot (R_{DS(ON)(HS)} \cdot V_o + R_{DS(ON)(LS)} \cdot [V_{IN} - V_o])}{V_{IN}} + (t_{sw} \cdot F \cdot I_o + I_Q) \cdot V_{IN}$$

I_Q is the step-down converter quiescent current. The term t_{sw} is used to estimate the full load step-down converter switching losses.

For the condition where the step-down converter is in dropout at 100% duty cycle, the total device dissipation reduces to:

$$P_{TOTAL} = I_o^2 \cdot R_{DS(ON)(HS)} + I_Q \cdot V_{IN}$$

Since $R_{DS(ON)}$, quiescent current, and switching losses all vary with input voltage, the total losses should be investigated over the complete input voltage range.

Given the total losses, the maximum junction temperature can be derived from the θ_{JA} for the SOT23-5 package which is 150°C/W.

$$T_{J(MAX)} = P_{TOTAL} \cdot \theta_{JA} + T_{AMB}$$

Output Dropout

At dropout, the duty cycle of AAT1141 switching is 100%. The minimum dropout voltage is determined by $R_{DS(ON)H}$ and the inductor copper loss resistor. AAT1141 has 0.35Ω $R_{DS(ON)H}$. The inductor copper loss resistor varies with different inductor values and manufacturer. The safe dropout voltage is 0.5V for a 600mA load.

For example, when load current is 600mA, the voltage dropped across $R_{DS(ON)H}$ is 0.21V; if the inductor copper loss resistor is 135mΩ, the voltage drop across the inductor is 0.08V. So the total voltage drop is 0.29V. Considering manufacturer's tolerances, the inductor copper loss resistor and $R_{DS(ON)H}$ will vary from part to part, a 0.4V dropout window is safe.

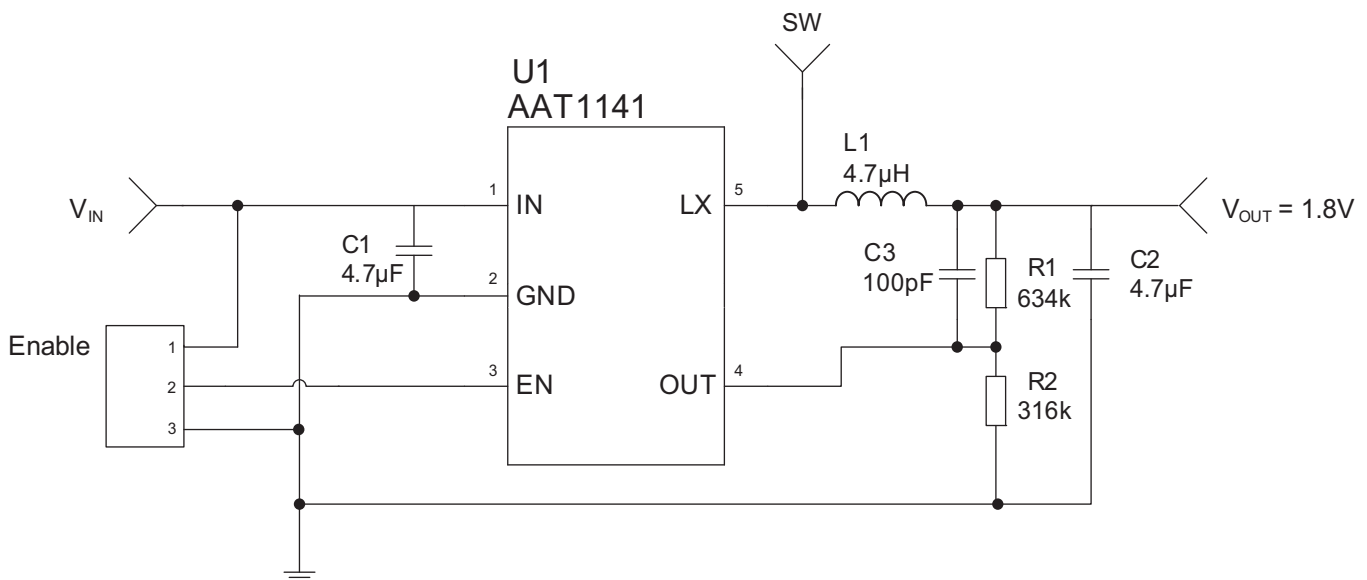

Figure 5: AAT1141 Adjustable Evaluation Board Schematic.

Efficiency

Besides the AAT1141 device losses including switching losses, conduction losses, and quiescent current losses, the inductor copper loss also affects the efficiency of the buck converter. To the buck converter, the average current of the inductor is equal to output current I_O . So the loss in the inductor is:

$$P_{\text{LOSS}_L} = I_O^2 \cdot R_L$$

Table 4 shows some recommended inductors. A larger size inductor usually has lower DCR. For example, if selecting CDRH2D14 4.7 μ H for 1.8V output, the P_{LOSS_L} is 48.6mW when the output current is 600mA, so the inductor loses 4.5% power; if selecting CDRH3D23 4.7 μ H, the P_{LOSS_L} should be 19.8mW, and the inductor power loss ratio is only 1.8%. The inductor size and the buck converter efficiency is always a trade-off in the real application.

Layout

The suggested 2-layer PCB layout for the AAT1141 is shown in Figures 2, 3 and 4. The following guide lines should be used to help ensure a proper layout.

1. The power traces (GND, LX, VIN) should be kept short, direct, and wide to allow large current flow. Place sufficient multiple-layer pads when needed to change the trace layer.
2. The input capacitor (C1) should connect as closely as possible to IN and GND.
3. The output capacitor C2 and L1 should be connected as closely as possible. The connection of L1 to the LX pin should be as short as possible and there should not be any signal lines under the inductor.
4. The feedback trace or OUT pin should be separate from any power trace and connect as closely as possible to the load point. Sensing along a high-current load trace will degrade DC load regulation. If external feedback resistors are used, they should be placed as closely as possible to the OUT pin to minimize the length of the high impedance feedback trace.
5. The resistance of the trace from the load return to GND should be kept to a minimum. This will help to minimize any error in DC regulation due to differences in the potential of the internal signal ground and the power ground.

Step-Down Converter Design Example

Specifications

$V_O = 1.8V$ @ 600mA (adjustable using 0.6V version), Pulsed Load $\Delta I_{LOAD} = 300mA$
 $V_{IN} = 2.7V$ to $4.2V$ (3.6V nominal)
 $F_S = 2MHz$
 $T_{AMB} = 85^\circ C$

1.8V Output Inductor

$$L_1 = 3 \frac{\mu S}{A} \cdot V_{O2} = 3 \frac{\mu S}{A} \cdot 1.8V = 5.4\mu H \text{ (use } 4.7\mu H; \text{ see Table 1)}$$

For Sumida inductor CDRH3D16, $4.7\mu H$, $DCR = 105m\Omega$.

$$\Delta I_{L1} = \frac{V_O}{L_1 \cdot F} \cdot \left(1 - \frac{V_O}{V_{IN}}\right) = \frac{1.8V}{4.7\mu H \cdot 2MHz} \cdot \left(1 - \frac{1.8V}{4.2V}\right) = 109.2mA$$

$$I_{PKL1} = I_O + \frac{\Delta I_{L1}}{2} = 0.6A + 0.055A = 0.655A$$

$$P_{L1} = I_O^2 \cdot DCR = 0.6A^2 \cdot 105m\Omega = 38mW$$

1.8V Output Capacitor

$$V_{DROOP} = 0.1V$$

$$C_{OUT} = \frac{3 \cdot \Delta I_{LOAD}}{V_{DROOP} \cdot F_S} = \frac{3 \cdot 0.3A}{0.1V \cdot 2MHz} = 4.48\mu F; \text{ use } 10\mu F$$

$$I_{RMS} = \frac{1}{2 \cdot \sqrt{3}} \cdot \frac{(V_O) \cdot (V_{IN(MAX)} - V_O)}{L_1 \cdot F \cdot V_{IN(MAX)}} = \frac{1}{2 \cdot \sqrt{3}} \cdot \frac{1.8V \cdot (4.2V - 1.8V)}{4.7\mu H \cdot 2MHz \cdot 4.2V} = 31.5mA_{RMS}$$

$$P_{esr} = esr \cdot I_{RMS}^2 = 5m\Omega \cdot (31.5mA)^2 = 5\mu W$$

Input Capacitor

Input Ripple $V_{PP} = 25mV$

$$C_{IN} = \frac{1}{\left(\frac{V_{PP}}{I_O} - ESR\right) \cdot 4 \cdot F_S} = \frac{1}{\left(\frac{25mV}{0.6A}\right) - 5m\Omega \cdot 4 \cdot 2MHz} = 3.4\mu F; \text{ use } 4.7\mu F$$

$$I_{RMS} = \frac{I_O}{2} = 0.3A_{RMS}$$

$$P = esr \cdot I_{RMS}^2 = 5m\Omega \cdot (0.3A)^2 = 0.45mW$$

AAT1141 Losses

$$\begin{aligned}
 P_{\text{TOTAL}} &= \frac{I_O^2 \cdot (R_{\text{DSON(HS)}} \cdot V_O + R_{\text{DSON(LS)}} \cdot [V_{\text{IN}} - V_O])}{V_{\text{IN}}} \\
 &+ (t_{\text{sw}} \cdot F \cdot I_O + I_Q) \cdot V_{\text{IN}} \\
 &= \frac{0.6^2 \cdot (0.35\Omega \cdot 1.8\text{V} + 0.3\Omega \cdot [4.2\text{V} - 1.8\text{V}])}{4.2\text{V}} \\
 &+ (5\text{ns} \cdot 2\text{MHz} \cdot 0.6\text{A} + 70\mu\text{A}) \cdot 4.2\text{V} = 141\text{mW}
 \end{aligned}$$

$$T_{\text{J(MAX)}} = T_{\text{AMB}} + \Theta_{\text{JA}} \cdot P_{\text{LOSS}} = 85^\circ\text{C} + (150^\circ\text{C/W}) \cdot 141\text{mW} = 106.2^\circ\text{C}$$

Adjustable Version (0.6V device) V_{OUT} (V)	R2 = 59k Ω R1 (k Ω)	R2 = 316k Ω ¹ R1 (k Ω)	L1 (μ H)
0.8	19.6	105	2.2
0.9	29.4	158	2.2
1.0	39.2	210	2.2
1.1	49.9	267	2.2
1.2	59.0	316	2.2
1.3	68.1	365	2.2
1.4	78.7	422	4.7
1.5	88.7	475	4.7
1.8	118	634	4.7
1.85	124	732	4.7
2.0	137	1000	6.8
2.5	187	1270	6.8
3.3	267	1430	6.8
Fixed Version V_{OUT} (V)	R2 Not Used R1 (k Ω)		L1 (μ H)
0.6-3.3V	0		4.7

Table 3: Evaluation Board Component Values.

Manufacturer	Part Number	Inductance (μ H)	Max DC Current (A)	DCR (Ω)	Size (mm) LxWxH	Type
Sumida	CDRH3D16-2R2	2.2	1.20	0.072	3.8x3.8x1.8	Shielded
Sumida	CDRH3D16-4R7	4.7	0.90	0.105	3.8x3.8x1.8	Shielded
Sumida	CDRH3D16-6R8	6.8	0.73	0.170	3.8x3.8x1.8	Shielded
Sumida	CDRH2D14	2.2	1.5	75	3.2x3.2x1.55	Shielded
		4.7	1.0	135		
		6.8	0.85	170		
Murata	LQH2MCN4R7M02	4.7	0.40	0.80	2.0x1.6x0.95	Non-Shielded
Murata	LQH32CN4R7M23	4.7	0.45	0.20	2.5x3.2x2.0	Non-Shielded
Coilcraft	LPO3310-472	4.7	0.80	0.27	3.2x3.2x1.0	1mm
Coiltronics	SD3118-4R7	4.7	0.98	0.122	3.1x3.1x1.85	Shielded
Coiltronics	SD3118-6R8	6.8	0.82	0.175	3.1x3.1x1.85	Shielded
Coiltronics	SDRC10-4R7	4.7	1.30	0.122	5.7x4.4x1.0	1mm Shielded

Table 4: Typical Surface Mount Inductors.

Manufacturer	Part Number	Value	Voltage	Temp. Co.	Case
Murata	GRM219R61A475KE19	4.7 μ F	10V	X5R	0805
Murata	GRM21BR60J106KE19	10 μ F	6.3V	X5R	0805
Murata	GRM21BR60J226ME39	22 μ F	6.3V	X5R	0805

Table 5: Surface Mount Capacitors.

1. For reduced quiescent current, R2 = 316k Ω .

Ordering Information

Output Voltage ¹	Package	Marking ²	Part Number (Tape and Reel) ³
Adj 0.6 to V_{IN}	TSOT23-5	YJXY	AAT1141ICB-0.6-T1
Adj 0.6 to V_{IN}	SOT23-5	1AXYY	AAT1141IGV-0.6-T1
1.0	SOT23-5	5AXYY	AAT1141IGV-1.0-T1
1.2	SOT23-5	4VXY	AAT1141IGV-1.2-T1
1.5	SOT23-5	5BXY	AAT1141IGV-1.5-T1
1.8	SOT23-5	ZEXYY	AAT1141IGV-1.8-T1
3.0	SOT23-5	5CXY	AAT1141IGV-3.0-T1
3.3	SOT23-5	5DXY	AAT1141IGV-3.3-T1



All AnalogicTech products are offered in Pb-free packaging. The term “Pb-free” means semiconductor products that are in compliance with current RoHS standards, including the requirement that lead not exceed 0.1% by weight in homogeneous materials. For more information, please visit our website at <http://www.analogictech.com/about/quality.aspx>.

Package Information

SOT23-5

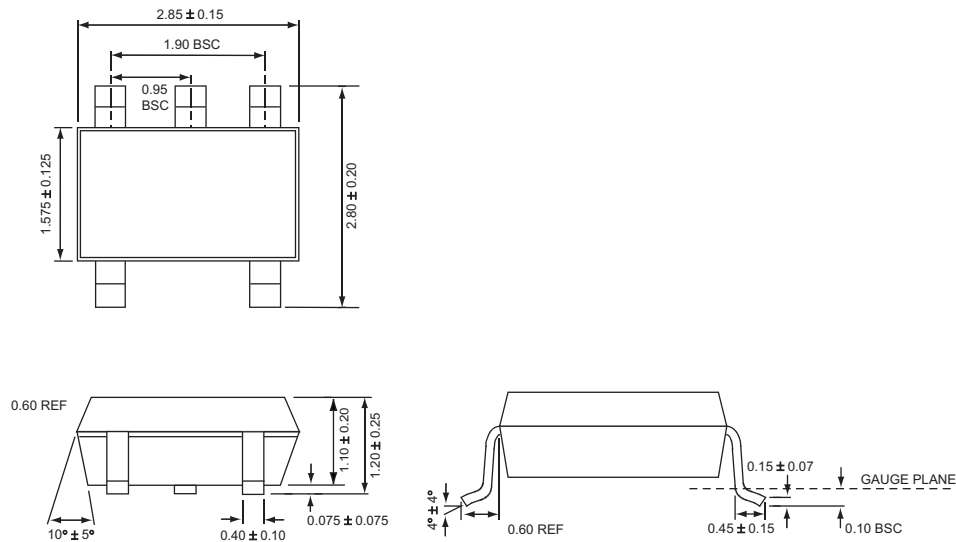

All dimensions in millimeters.

1. Contact Sales for other voltage options.
 2. XYY = assembly and date code.
 3. Sample stock is generally held on part numbers listed in **BOLD**.

TSOT23-5

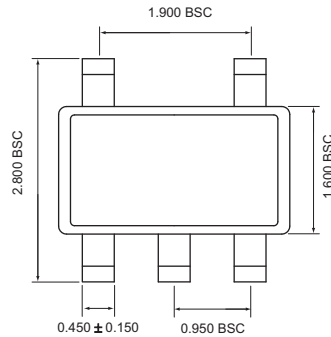

Top View

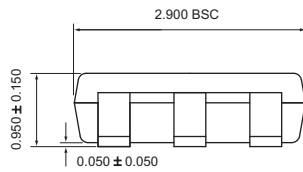

Side View

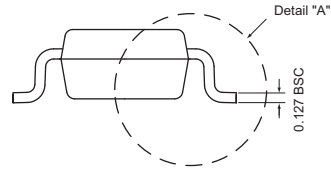

End View

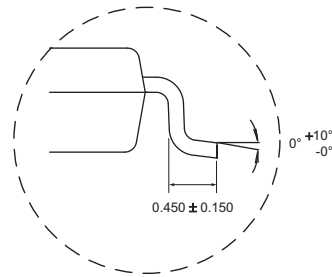

Detail "A"

All dimensions in millimeters.

Advanced Analogic Technologies, Inc.
 3230 Scott Boulevard, Santa Clara, CA 95054
 Phone (408) 737-4600
 Fax (408) 737-4611

© Advanced Analogic Technologies, Inc. AnalogicTech cannot assume responsibility for use of any circuitry other than circuitry entirely embodied in an AnalogicTech product. No circuit patent licenses, copyrights, mask work rights, or other intellectual property rights are implied. AnalogicTech reserves the right to make changes to their products or specifications or to discontinue any product or service without notice. Except as provided in AnalogicTech's terms and conditions of sale, AnalogicTech assumes no liability whatsoever, and AnalogicTech disclaims any express or implied warranty relating to the sale and/or use of AnalogicTech products including liability or warranties relating to fitness for a particular purpose, merchantability, or infringement of any patent, copyright or other intellectual property right. In order to minimize risks associated with the customer's applications, adequate design and operating safeguards must be provided by the customer to minimize inherent or procedural hazards. Testing and other quality control techniques are utilized to the extent AnalogicTech deems necessary to support this warranty. Specific testing of all parameters of each device is not necessarily performed. AnalogicTech and the AnalogicTech logo are trademarks of Advanced Analogic Technologies Incorporated. All other brand and product names appearing in this document are registered trademarks or trademarks of their respective holders.