



STTH8R06D/FP/G/R

TURBO 2 ULTRAFAST HIGH VOLTAGE RECTIFIER

MAIN PRODUCT CHARACTERISTICS

$I_{F(AV)}$	8 A
V_{RRM}	600 V
$I_{RM}(typ.)$	5.5A
$T_j(max)$	175 °C
$V_F(max)$	1.8 V
$t_{rr}(max)$	45 ns

FEATURES AND BENEFITS

- Ultrafast switching
- Low reverse recovery current
- Reduces switching losses
- Low thermal resistance

DESCRIPTION

The STTH8R06D/FP/G/R, which is using ST 600V technology, is specially suited as boost diode in continuous mode power factor corrections and hard switching conditions.

The device is also intended for use as a free wheeling diode in power supplies and other power switching applications.

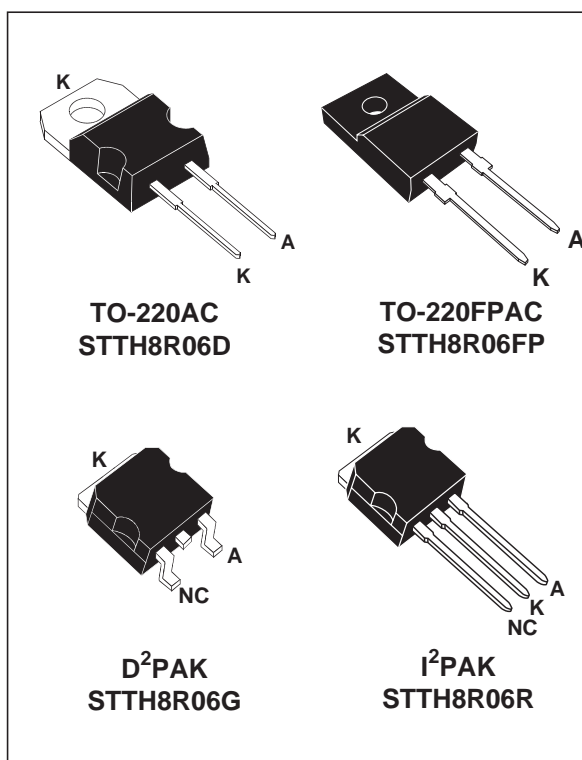

ABSOLUTE RATINGS (limiting values)

Symbol	Parameter		Value	Unit
V_{RRM}	Repetitive peak reverse voltage		600	V
$I_{F(RMS)}$	RMS forward current		30	A
$I_{F(AV)}$	Average forward current $\delta = 0.5$	TO-220AC $T_c = 130^\circ\text{C}$ D ² PAK / I ² PAK $T_c = 130^\circ\text{C}$ TO-220FPAC $T_c = 85^\circ\text{C}$	8	A
I_{FSM}	Surge non repetitive forward current	$t_p = 10\text{ ms}$ Sinusoidal	80	A
T_{stg}	Storage temperature range		- 65 + 175	°C
T_j	Maximum operating junction temperature		+ 175	°C

STTH8R06D/FP/G/R

THERMAL RESISTANCES

Symbol	Parameter		Value	Unit
R _{th(j-c)}	Junction to case	TO-220AC / D ² PAK / I ² PAK	2.2	°C/W
		TO-220FPAC	4.6	

STATIC ELECTRICAL CHARACTERISTICS

Symbol	Parameter	Tests conditions		Min.	Typ.	Max.	Unit
I _R	Reverse leakage current	V _R = 600V	T _j = 25°C			30	μA
			T _j = 125°C		35	400	
V _F	Forward voltage drop	I _F = 8 A	T _j = 25°C			2.9	V
			T _j = 125°C		1.4	1.8	

To evaluate the maximum conduction losses use the following equation :
 $P = 1.16 \times I_{F(AV)} + 0.08 I_{F(RMS)}^2$

DYNAMIC ELECTRICAL CHARACTERISTICS

Symbol	Tests conditions		Min.	Typ.	Max.	Unit
trr	I _F = 0.5 A I _{rr} = 0.25 A I _R = 1A	T _j = 25°C			25	ns
	I _F = 1 A dI _F /dt = - 50 A/μs V _R = 30V				45	
I _{RM}	V _R = 400 V I _F = 8A dI _F /dt = - 200A/μs	T _j = 125°C		5.5	7.2	A
S factor				0.3		
Qrr				150		
tfr	I _F = 8 A dI _F /dt = 64 A/μs	T _j = 25°C			150	ns
V _{FP}	V _{FR} = 1.1 x V _{Fmax}				5	V

Fig. 1: Conduction losses versus average current.

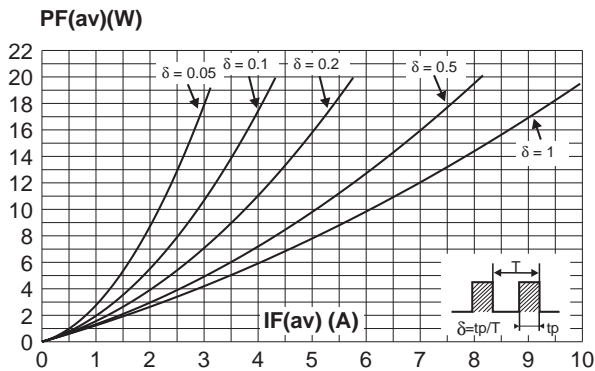

Fig. 2: Forward voltage drop versus forward current.

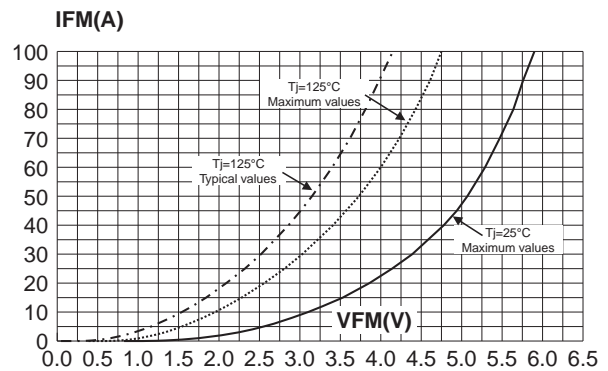

Fig. 3-1: Relative variation of thermal impedance junction to case versus pulse duration (TO-220AC, I²PAK, D²PAK).

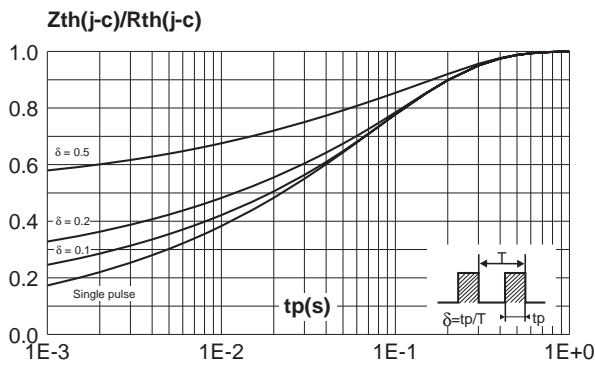

Fig. 3-2: Relative variation of thermal impedance junction to case versus pulse duration (TO-220FPAC).

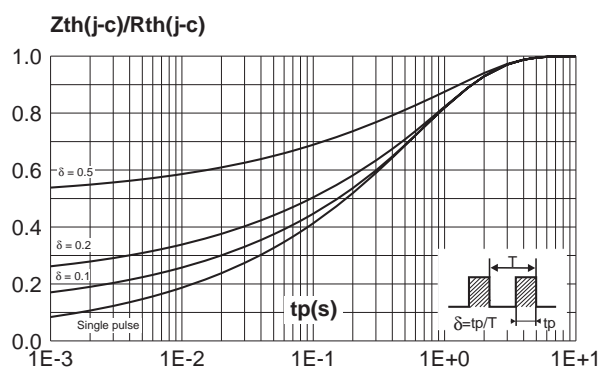

Fig. 4: Peak reverse recovery current versus dI_F/dt (90% confidence).

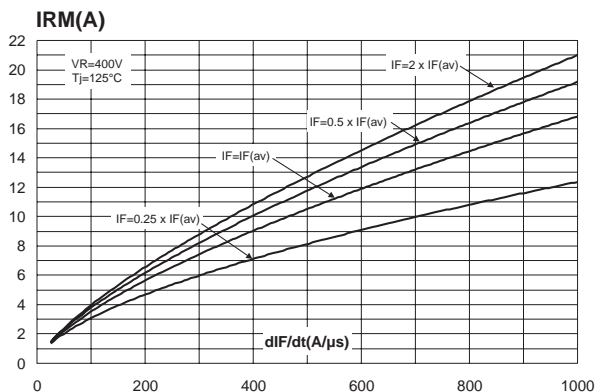

Fig. 5: Reverse recovery time versus dI_F/dt (90% confidence).

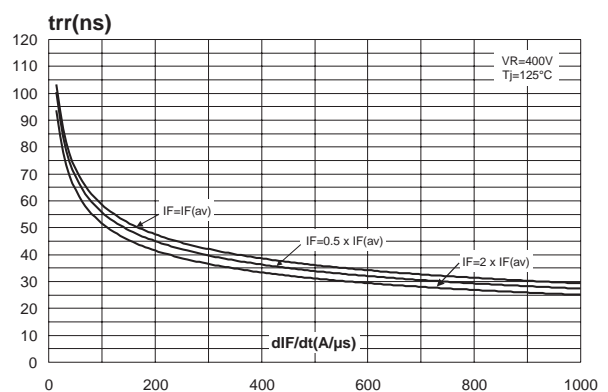

Fig. 6: Reverse recovery charges versus dI_F/dt (90% confidence).

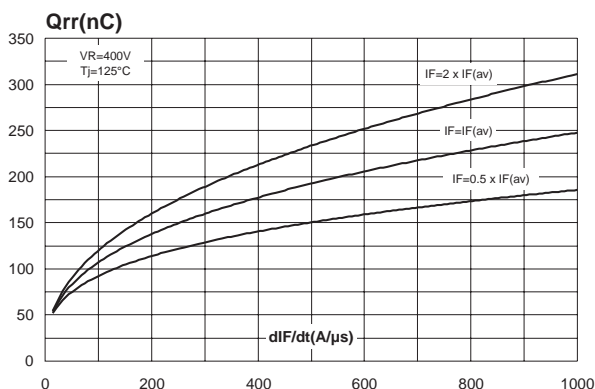

Fig. 7: Softness factor (t_b/t_a) versus dI_F/dt (typical values).

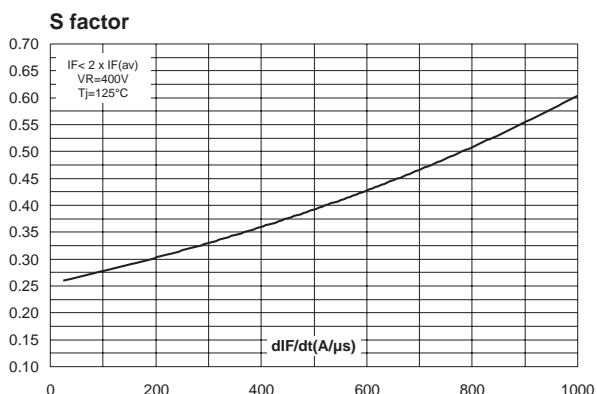

Fig. 8: Relative variation of dynamic parameters versus junction temperature (Reference: $T_j=125^\circ\text{C}$).

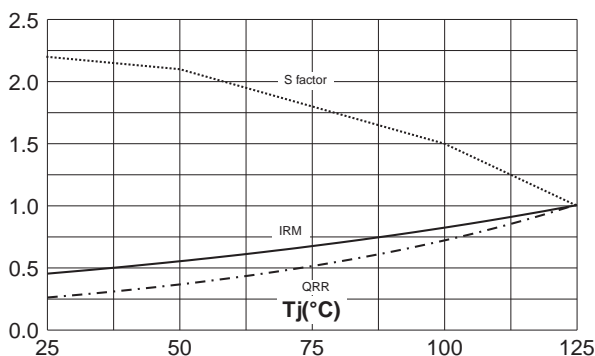

Fig. 9: Transient peak forward voltage versus dI_F/dt (90% confidence).

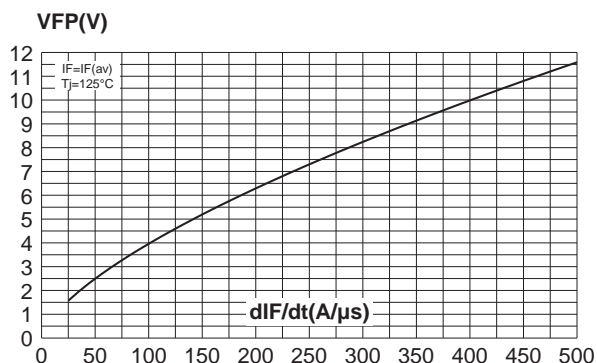

Fig. 10: Forward recovery time versus dI_F/dt (90% confidence).

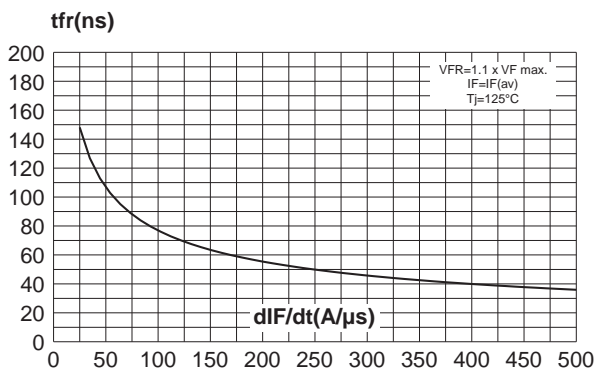
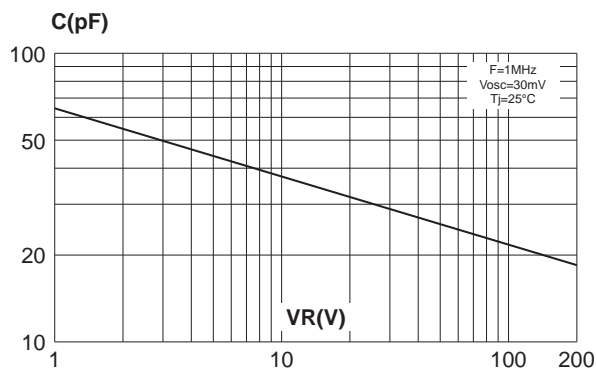
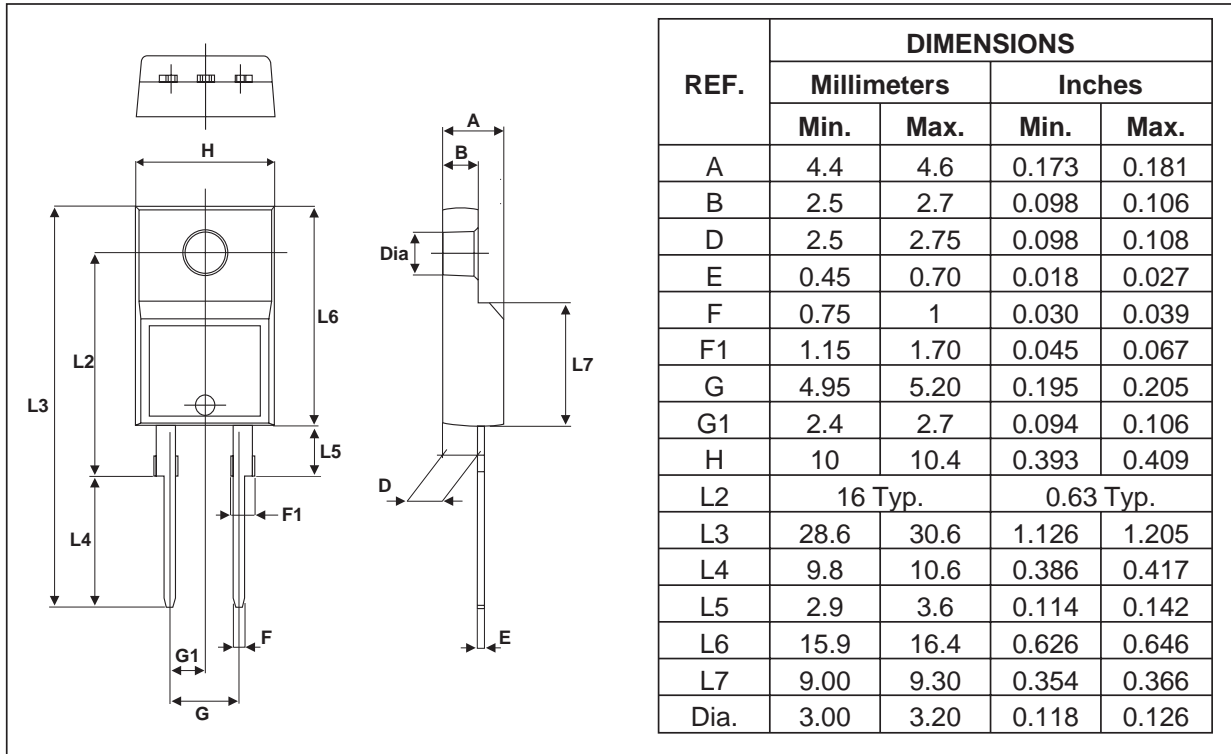

Fig. 11: Junction capacitance versus reverse voltage applied (typical values).



PACKAGE MECHANICAL DATA
TO-220FPAC



PACKAGE MECHANICAL DATA
TO-220AC

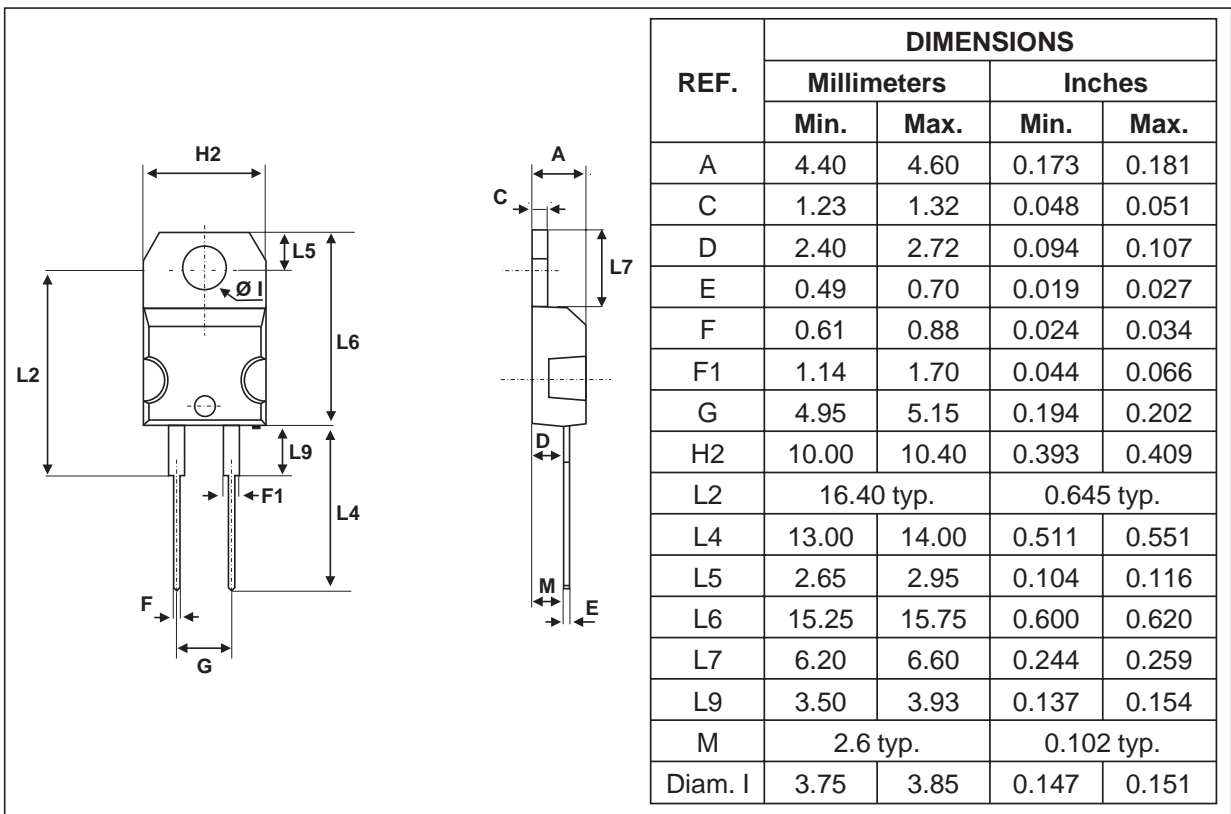

PACKAGE MECHANICAL DATA

D²PAK

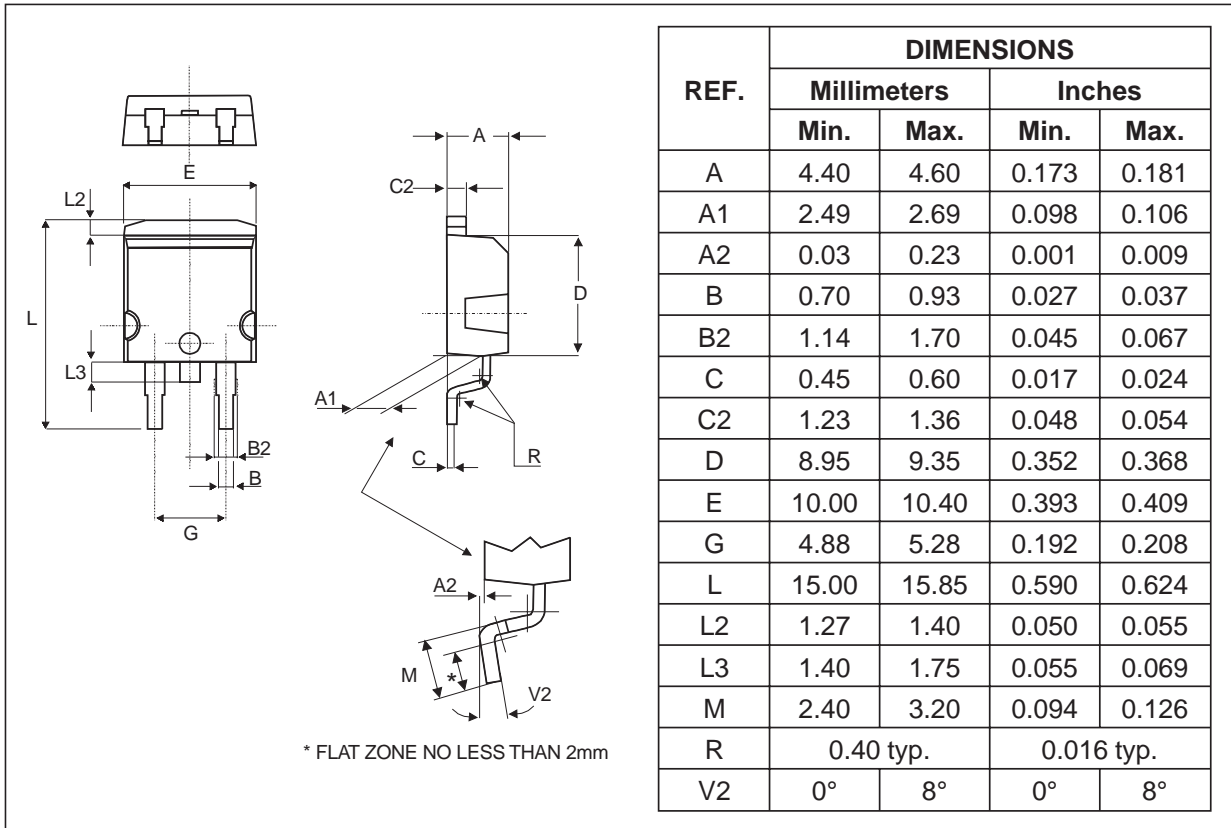

FOOTPRINT (in millimeters)

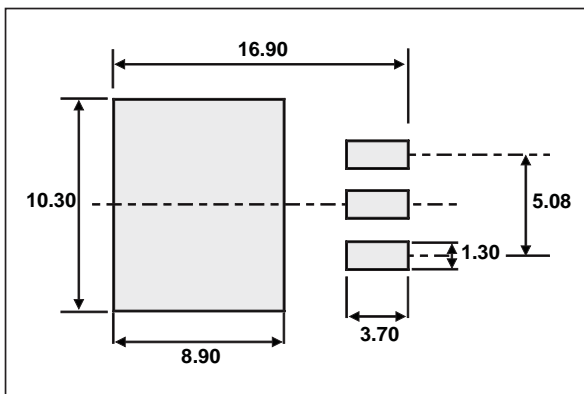

STTH8R06D/FP/G/R

PACKAGE MECHANICAL DATA

I²PAK

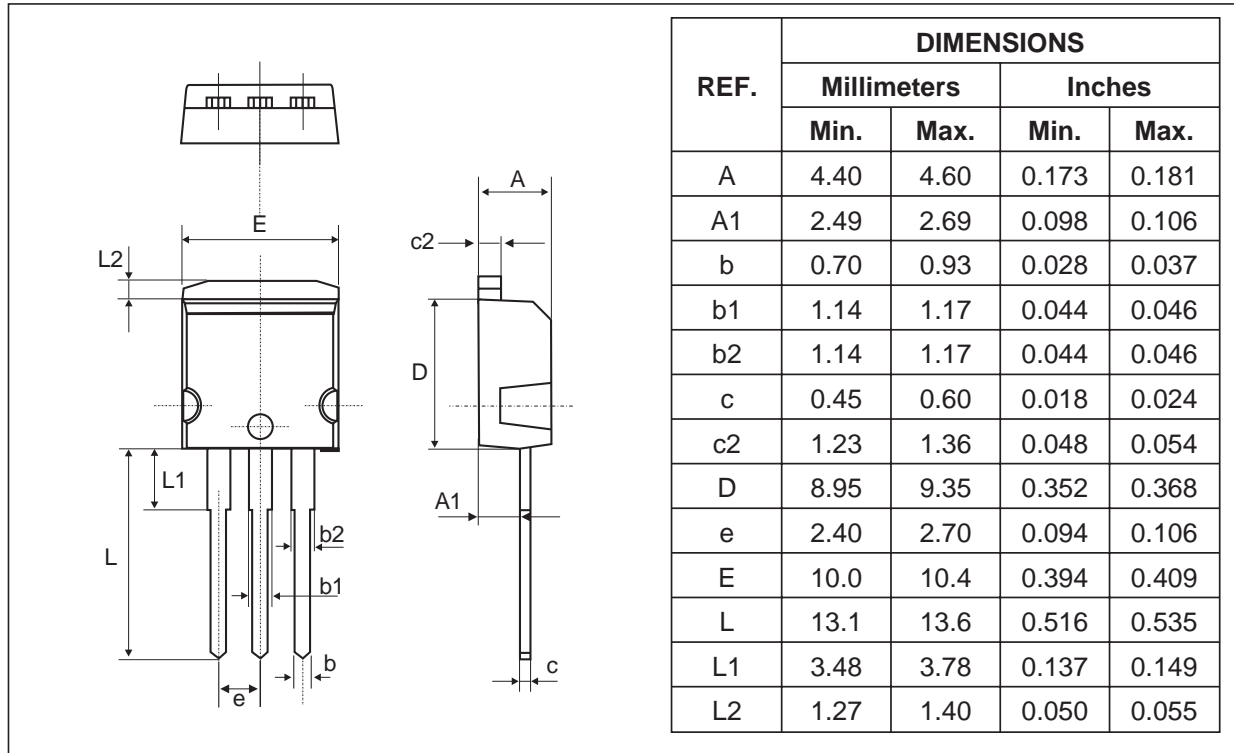

Ordering code	Marking	Package	Weight	Base qty	Delivery mode
STTH8R06D	STTH8R06D	TO-220AC	1.9 g	50	Tube
STTH8R06FP	STTH8R06FP	TO-220FPAC	1.7 g	50	Tube
STTH8R06G	STTH8R06G	D ² PAK	1.5 g	50	Tube
STTH8R06R	STTH8R06R	I ² PAK	1.5 g	50	Tube

- Cooling method: by conduction (C)
- Recommended torque value (TO-220AC): 0.55 Nm
- Maximum torque value (TO-220AC / TO-220FPAC): 0.7 Nm
- Epoxy meets UL 94,V0

Information furnished is believed to be accurate and reliable. However, STMicroelectronics assumes no responsibility for the consequences of use of such information nor for any infringement of patents or other rights of third parties which may result from its use. No license is granted by implication or otherwise under any patent or patent rights of STMicroelectronics. Specifications mentioned in this publication are subject to change without notice. This publication supersedes and replaces all information previously supplied. STMicroelectronics products are not authorized for use as critical components in life support devices or systems without express written approval of STMicroelectronics.

The ST logo is a registered trademark of STMicroelectronics
 © 2002 STMicroelectronics - Printed in Italy - All rights reserved.

STMicroelectronics GROUP OF COMPANIES
 Australia - Brazil - Canada - China - Finland - France - Germany
 Hong Kong - India - Israel - Italy - Japan - Malaysia - Malta - Morocco - Singapore
 Spain - Sweden - Switzerland - United Kingdom - United States.

<http://www.st.com>

