

## 571-4133 Insulated solder terminal, Pin type

Recommended mounting hole .203 (5,16)

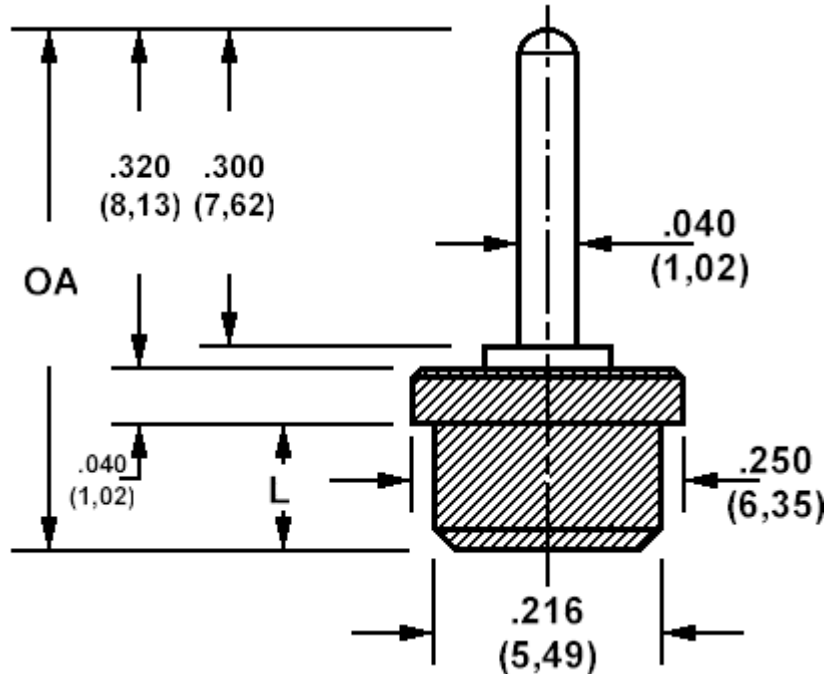

### How to order code

**571-4133-XX-YY-19**

Basic Part No (XX = Panel thickness, YY = plating finish. See tables for options)

Basic Part No.		OA (ref)	L	Panel Thickness (XX)
571-4133	-01	.460 (11,68)	.100 (2,54)	.031 (0,79) to .062 (1,59)

Component	Material	Finish (YY)	
		-01	-05
Terminal	Brass	Silver	Electro Solder
Insulator	Teflon - white		

Additional Specifications	
Flashover VRMS at Sea Level	3000
Capacitance (pF)	0.5

Teflon is a registered trademark of Dupont