

HMC-T2100B

Portable Synthesized Signal Generator, 10 MHz to 20 GHz

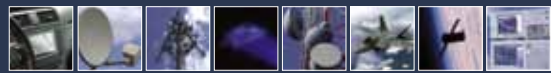

***Portable & Battery
Operated!***

HMC-T2100B

PORTABLE SYNTHESIZED SIGNAL GENERATOR, 10 MHz to 20 GHz

v03.0411

Industry's First Battery Operated 20 GHz Signal Generator!

The HMC-T2100B is a battery powered, portable test equipment solution designed to fulfill your signal generation needs in the field or on the bench. The HMC-T2100B provides the highest output power, lowest harmonic levels and broadest frequency range amongst portable signal generators of its size and cost.

Internal rechargeable batteries allow for 4 hours of continuous operation, making the HMC-T2100B a portable and versatile instrument, which is particularly attractive for wireless/wired service installation, field testing, or remote on-site maintenance applications. The HMC-T2100B also features USB, GPIB and Ethernet interfaces with innovative control software ensuring carefree integration within various test environments while improving overall productivity and equipment utilization.

Applications

- ◆ Field Testing
- ◆ Service Installation
- ◆ ATE, Test & Measurement
- ◆ R&D Laboratories

Advantages

- ◆ Portable: 5 kg (11 lbs) ^[1]
- ◆ Versatile: High Power Simplifies Test Set-Ups
- ◆ Efficient: 300 μ s Frequency Switching
- ◆ Flexible: Manual or Software Control Via USB, GPIB or Ethernet

Performance

- ◆ Battery Operation: 4 Hours ^[2]
- ◆ High Output Power: +27 dBm
- ◆ Wide Frequency Range: 10 MHz to 20 GHz
- ◆ Excellent Phase Noise Performance: -113 dBc/Hz @ 100 kHz Offset @ 1 GHz
- ◆ Spurious Rejection: -65 dBc @ 10 GHz
- ◆ Power Resolution: 0.1 dB
- ◆ Frequency Resolution: 10 kHz



**Four Hours
Continuous Operation!**

HMC-T2100B

PORTABLE SYNTHESIZED SIGNAL GENERATOR, 10 MHz to 20 GHz

v03.0411

Frequency

Accuracy: As Per Internal Ref. ± 1.5 ppm
 Resolution: 10 kHz
 Internal Reference: 10 MHz
 Aging Rate: < 1 ppm/yr
 External Reference Input: 10 MHz (Sine)
 Internal Reference Output: 10 MHz (Sine)

Output Power (Maximum Leveled)

| Frequency (GHz) | Power Output (dBm) |
|-----------------|--------------------|
| 0.01 | 22 |
| 0.05 | 26 |
| 0.1 | 26 |
| 0.5 | 25 |
| 1 | 25 |
| 2 | 26 |
| 4 | 27 |
| 10 | 25 |
| 15 | 24 |
| 20 | 22 |

Minimum Settable: -15 dBm (all frequencies)
 Dynamic Range: > 40 dB @ 10 GHz
 Resolution: 0.1 dB
 Output Source Match: $< 2.0:1$
 Power Accuracy: ± 1 dB for leveled outputs

Output Power Range @ 25°C

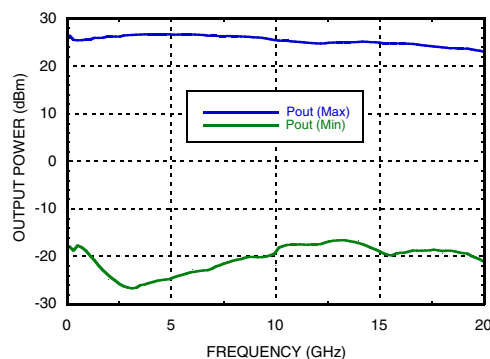

SSB Phase Noise vs. Frequency

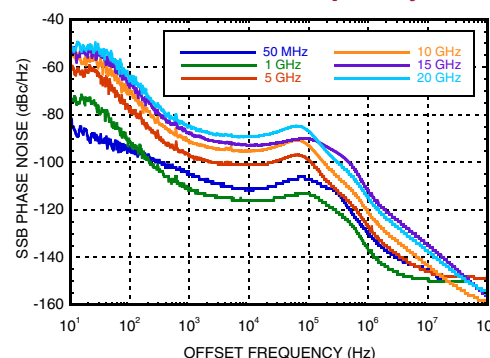

Spectral Purity*

| Frequency (GHz) | 2nd Harmonics (dBc) | 3rd Harmonics (dBc) | Spurious (dBc) |
|-----------------|---------------------|---------------------|----------------|
| 0.01 | -20 | -36 | -78 |
| 0.05 | -36 | -41 | -52 |
| 0.1 | -21 | -31 | -80 |
| 0.5 | -27 | -38 | -80 |
| 1 | -39 | -49 | -80 |
| 2 | -32 | -52 | -89 |
| 5 | -38 | -56 | -75 |
| 10 | -29 | -55 | -65 |
| 15 | -27 | -44 | -51 |
| 20 | -42 | - | -55 |

Output Power = +10 dBm

*Spurious at integer mode frequencies shown above.
 Spurious at fractional mode frequencies may be higher.

SSB Phase Noise (dBc/Hz)

| Frequency (GHz) | Offset From Carrier | | | | | | |
|-----------------|---------------------|--------|-------|--------|---------|-------|--------|
| | 10 Hz | 100 Hz | 1 kHz | 10 kHz | 100 kHz | 1 MHz | 10 MHz |
| 0.01 | -79 | -89 | -97 | -105 | -104 | -126 | n/a |
| 0.05 | -89 | -95 | -105 | -111 | -107 | -130 | -145 |
| 0.1 | -83 | -94 | -105 | -112 | -107 | -129 | -145 |
| 0.5 | -80 | -96 | -117 | -122 | -119 | -142 | -150 |
| 1 | -73 | -91 | -111 | -116 | -113 | -137 | -149 |
| 2 | -67 | -83 | -106 | -110 | -107 | -131 | -147 |
| 5 | -59 | -77 | -98 | -101 | -99 | -127 | -146 |
| 10 | -55 | -69 | -92 | -95 | -93 | -121 | -143 |
| 15 | -51 | -67 | -87 | -93 | -90 | -112 | -135 |
| 20 | -53 | -66 | -85 | -89 | -87 | -115 | -137 |

Output Noise: Floor < -155 dBc/Hz

Above data is typical performance at +25°C after 30 minutes of warm-up time unless otherwise stated.



20 Alpha Road Chelmsford, MA 01824
 Phone: 978-250-3343 Fax: 978-250-3373
 Order Online at www.hittite.com

Instrumentation Product Support at TE@hittite.com

HMC-T2100B

PORTABLE SYNTHESIZED SIGNAL GENERATOR, 10 MHz to 20 GHz

v03.0411

General Specifications

Power - AC:

100 to 240 VAC @ 50 to 60 Hz

Power - Battery:

Type: Lithium Ion, Capacity: 6750 mAh (73Wh)
Rated Voltage: 10.8V

Calibration: 1 Year

Environment: 0 to 35 °C

Cooling: 2 Internal Fans

Input / Output:

10 MHz REFOUT ^[1]

10 MHz REFIN ^[2]

TRIGGER IN ^[3]: LVTTTL

RS-232 (factory use only)

Ethernet

GPIB

USB 1.1/2.0

Mechanical Vibration & Shock:

MIL PRF-288000 Class 4

Compliance:

CSA, CE

General Mechanical Characteristics

H: 76 mm (3 in)

W: 203 mm (8 in)

D: 305 mm (12 in)

Weight: 5 kg (11 lbs)

Warranty: 1 Year Parts and Labor

[1] +10 dBm max into 50 Ohms; BNC Connector

[2] -5 dBm max, 50 Ohms; BNC Connector

[3] The trigger input can be driven from either 3.3V or 5V sources for direct interface with TTL signal levels; BNC Connector

Battery Operation

The HMC-T2100B contains two removable batteries, plus an internal battery charger that automatically recharges the batteries when the HMC-T2100B is powered from an AC source. The HMC-T2100B can continuously operate with one (2 hours) or two (4 hours) batteries. The recharge time for either one or two batteries is 6.5 hours during which the unit can be operated.



Remove both batteries
during transport

For proper battery use and storage please see the "Safety" section of the *HMC-T2100 / HMC-T2100B User Manual*. To view the *HMC-T2100 / HMC-T2100B User Manual*, please visit www.hittite.com and choose HMC-T2100 or HMC-T2100B from the "Search by Part Number" pull down menu.

HMC-T2100B

PORTABLE SYNTHESIZED SIGNAL GENERATOR, 10 MHz to 20 GHz

v03.0411

Two Tone Third Order Intercept Test Set-up

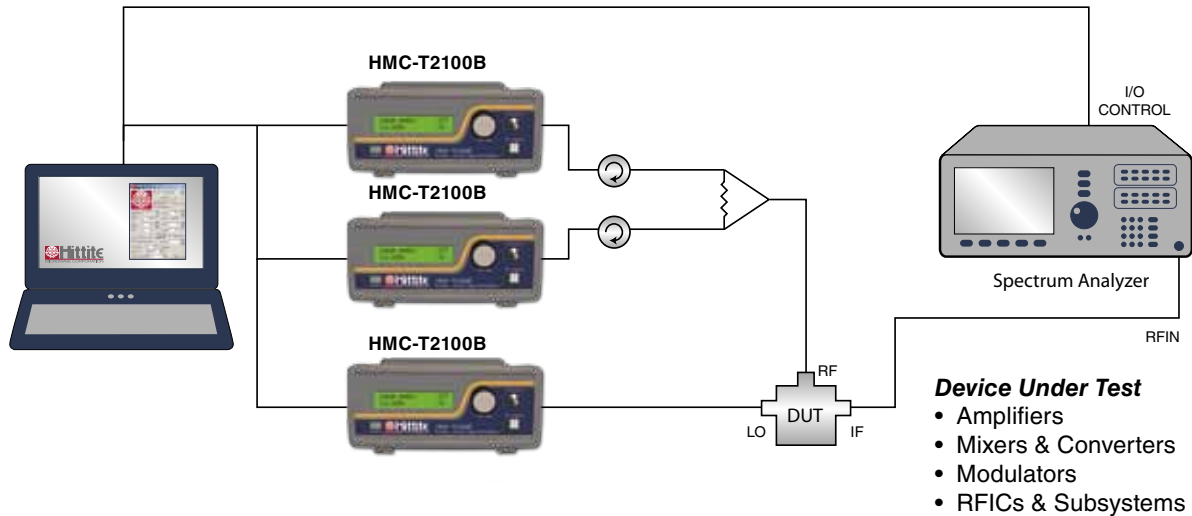

Efficient Mixer Conversion Loss, Isolation & MxN Spurious Test Set-up

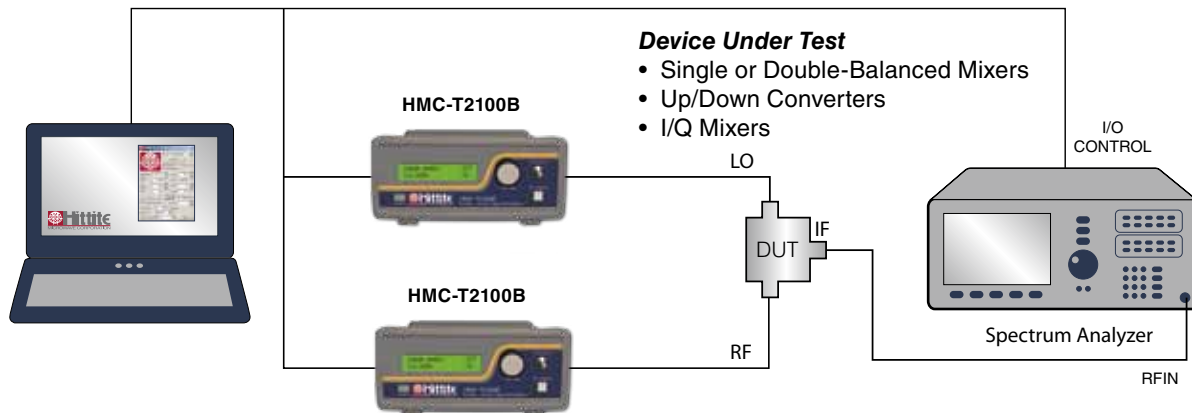

HMC-T2100B

PORTABLE SYNTHESIZED SIGNAL GENERATOR, 10 MHz to 20 GHz

v03.0411

Rear Panel I/O Connections



Connectivity & Control

The compact size, light weight, fast switching speed and USB, GBIP and Ethernet control interfaces support the standard SCPI command set ensuring smooth integration within all test environments, particularly those associated with automated test. An installation disk that accompanies each unit includes all the drivers required to remotely control the device as well as a user friendly GUI interface (right) compatible with a Windows XP® or Windows Vista® operating system. This GUI interface is identical for both HMC-T2100 and HMC-T2100B models. User control is facilitated via pull down menus that allow programming of single or swept modes in frequency and/or power. Integration of multiple units within a production test environment is easy, and affordable.

Remote Interface

Hardware: USB (Windows XP® and Windows Vista® Drivers Supplied), GPIB or Ethernet

Software: LabVIEW Driver (XP)

Frequency Switching Speed:
300 μ s Typical

Local Interface

Front Panel Rotary Knob & Display

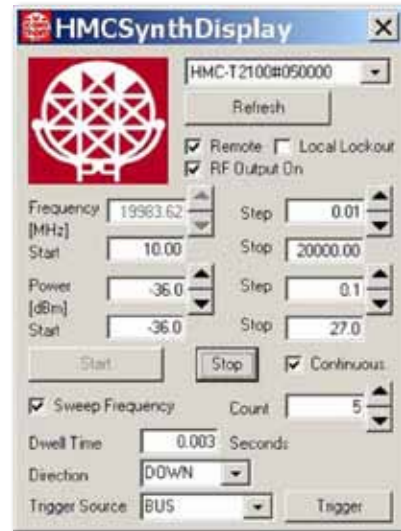

HMC-T2100B

PORTABLE SYNTHESIZED SIGNAL GENERATOR, 10 MHz to 20 GHz

v03.0411

Ordering Information



HMC-T2100B











| Model Number | Description | Price |
|-------------------|--|-------------|
| HMC-T2100B | Synthesized Signal Generator 10 MHz to 20 GHz | \$14,998.00 |

Includes two rechargeable batteries, 100 - 240V AC Power Supply and one Power Cord at no cost. Please specify your preferred power cord part number at time of ordering. (see "Optional Power Cord" table)

HMC-T2100B Battery

| Model Number | Description | Price |
|---------------------------|--|----------|
| HMC-T2100B-BATTERY | Lithium-Ion Battery Pack 10.8V, 6900mAh | \$179.00 |

Power Cord

| Part Number | Region | |
|-------------|------------------------|---|
| HMC-PC01 | Continental Europe |  |
| HMC-PC02 | United Kingdom |  |
| HMC-PC03 | China |  |
| HMC-PC04 | Australia, New Zealand |  |
| HMC-PC05 | North America |  |
| HMC-PC06 | South Africa / India |  |
| HMC-PC07 | Switzerland |  |
| HMC-PC08 | Denmark |  |
| HMC-PC09 | Israel |  |
| HMC-PC10 | Italy |  |
| HMC-PC11 | Japan |  |

All pricing is in U.S. Dollars and is subject to change without notice.



20 Alpha Road Chelmsford, MA 01824
Phone: 978-250-3343 Fax: 978-250-3373
Order Online at www.hittite.com
Instrumentation Product Support at TE@hittite.com

HMC-T2100B

PORTABLE SYNTHESIZED SIGNAL GENERATOR, 10 MHz to 20 GHz

v03.0411

Notes:

9

SYNTHESIZED SIGNAL GENERATOR

9 - 8



20 Alpha Road Chelmsford, MA 01824
Phone: 978-250-3343 Fax: 978-250-3373
Order Online at www.hittite.com
Instrumentation Product Support at TE@hittite.com