

Chip LEDs with reflectors

SML-011 / 012 series

The SML-011 / 012 series are ultra high luminance chip LEDs with reflectors by using AlGaInP die.

●Features

- 1) Reflectors are used to achieve a high luminance.
- 2) Two series : SML-011, SML-012
Three colors : red, orange and yellow
- 3) Rectangular and leadless (3×2mm).
- 4) Can be mounted by automatic mounting.

●External dimensions (Units : mm)

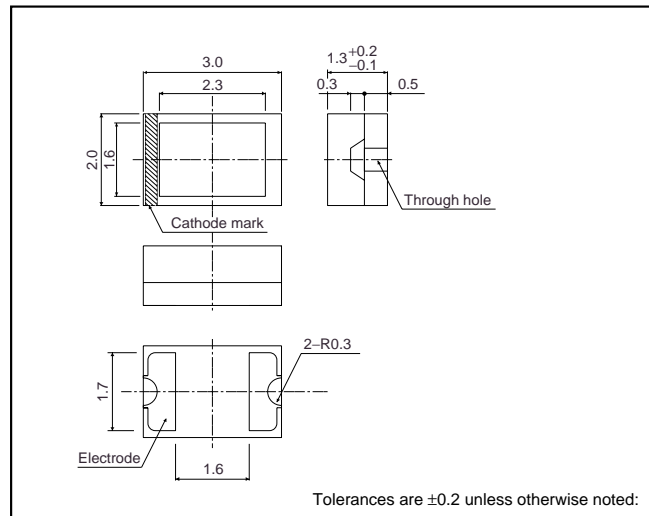

●Selection guide

Emitting color Lens	Red	Orange	Yellow
	Transparent clear	SML-011UT	SML-011DT
	SML-012UT	SML-012DT	SML-012YT

●Absolute maximum ratings (Ta=25°C)

Parameter	Symbol	Limits	Unit
Power dissipation	P_D	78	mW
Forward current	I_F	30	mA
Peak forward current	I_{FP}	60	mA*
Reverse voltage	V_R	4	V
Operating temperature	T_{opr}	-40~+100	°C
Storage temperature	T_{stg}	-40~+100	°C

* Pulse width 1ms Duty 1 / 5

Light Emitting Diodes

●Electrical and optical characteristics (Ta=25°C)

Type	Parameter	Color	Forward voltage			Reverse current		Luminous intensity			Peak wavelength		Spectral line half width	
			V _F (V)		Cond.	I _R (μA)	Cond.	I _v (mcd)		λ _P (nm)	Cond.	Δλ (nm)	Cond.	
			Typ.	Max.	I _F (mA)	Max.	V _R (V)	Min.	Typ.	I _F (mA)	Typ.	I _F (mA)	Typ.	I _F (mA)
SML-011	UT	Red	2.0	2.6	20	100	4	22.0	63.0	20	630	20	18	20
	DT	Orange	2.0	2.6	20	100	4	22.0	63.0	20	611	20	17	20
	YT	Yellow	2.0	2.6	20	100	4	22.0	63.0	20	590	20	15	20
SML-012	UT	Red	2.0	2.6	20	100	4	36.0	100	20	630	20	18	20
	DT	Orange	2.0	2.6	20	100	4	36.0	100	20	611	20	17	20
	YT	Yellow	2.0	2.6	20	100	4	36.0	100	20	590	20	15	20

●Directional pattern

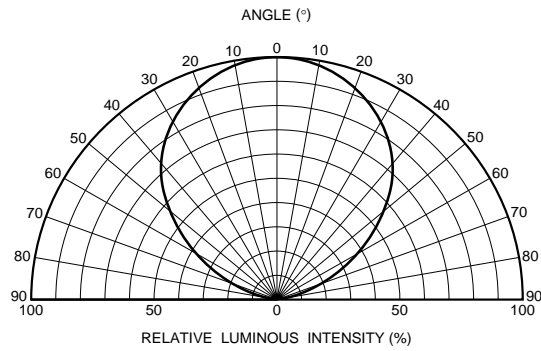

Fig.1 Directional pattern

●Electrical characteristic curves

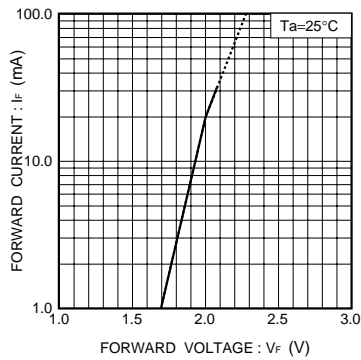

Fig.2 Forward current vs. forward voltage

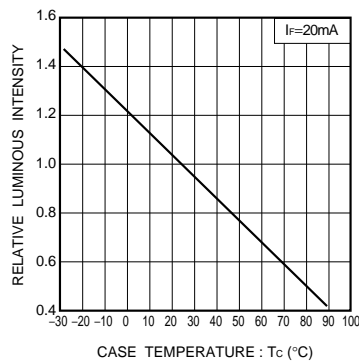

Fig.3 Luminous intensity vs. case temperature

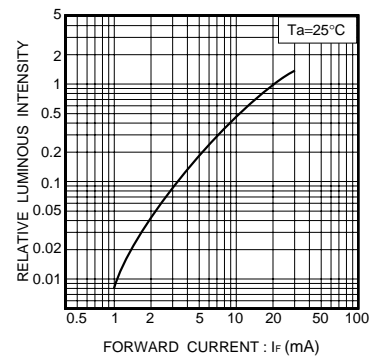

Fig.4 Luminous intensity vs. forward current

Light Emitting Diodes

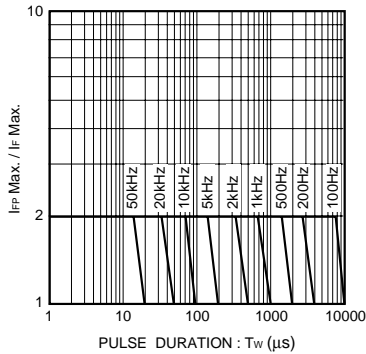

Fig.5 Maximum tolerable peak current vs. pulse duration

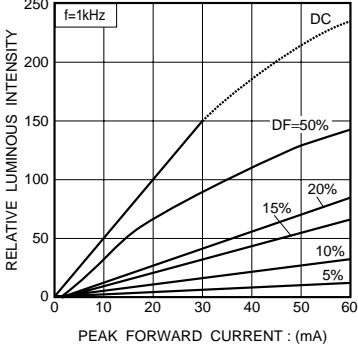

Fig.6 Luminous intensity vs. forward current

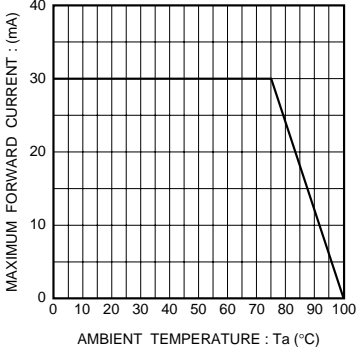

Fig.7 Derating