

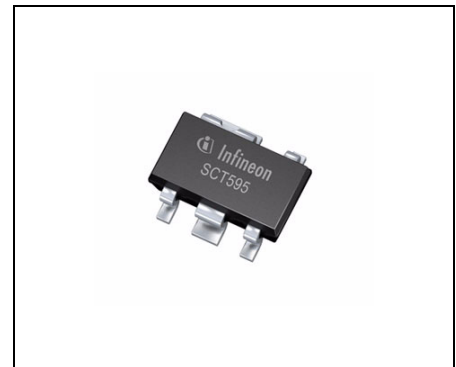

Features

- 15 mA current capability
- Low quiescent current consumption
- Power fail output
- Wide operation range: up to 45 V
- Wide temperature range: -40 °C to 150 °C
- Output protected against short circuit
- Overtemperature protection
- Very small SMD-Package PG-SCT-595-5
- Green product (RohS compliant)
- AEC qualified



PG-SCT-595-5

Functional Description

The **TLE 4285 G** is a 5-V fixed voltage regulator in a very small SMD package PG-SCT-595-5. The maximum input voltage is 45 V. The output is able to drive an output current of more than 10 mA while it regulates the output voltage within a 4% accuracy.

The Power Fail Output (open collector) is switched to low in case of under-voltage at the output pin. To reduce external components the Power Fail Output has an internal pull-up resistor of 50 k Ω which is connected to the output Q.

The device incorporates a temperature protection that disables the circuit at overtemperature.

Type	Package	Marking
TLE 4285 G	PG-SCT-595-5	B1

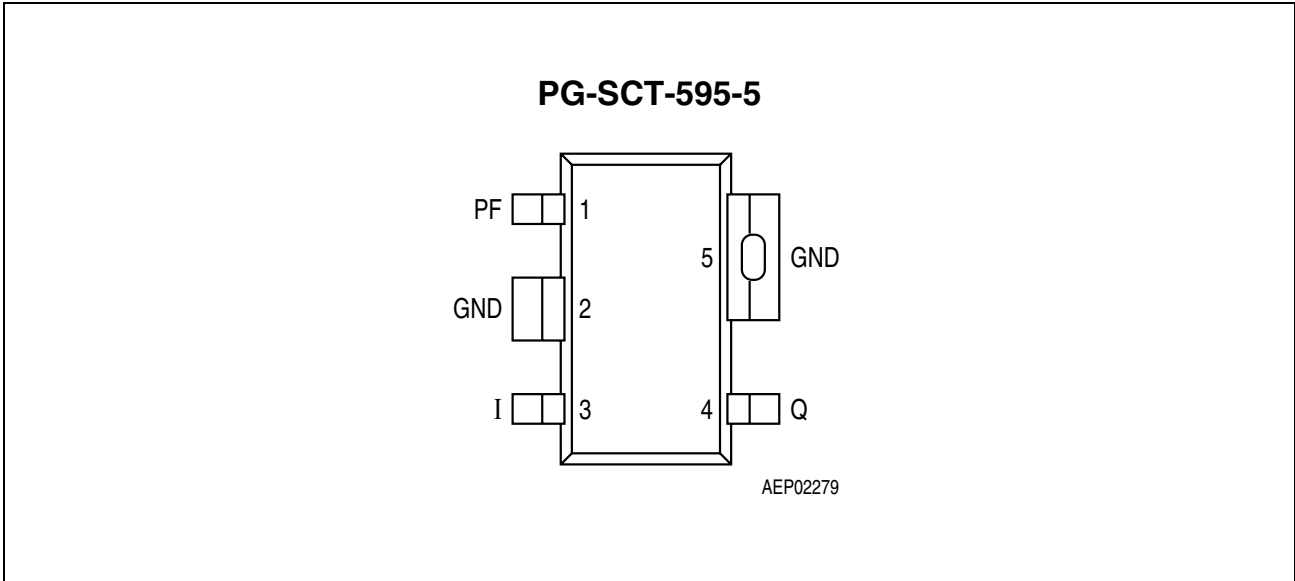

Figure 1 Pin Configuration (top view)

Table 1 Pin Definitions and Functions

Pin No.	Symbol	Function
1	PF	Power Fail ; L for under-voltage; internally connected to Q via 50 kΩ pull-up resistor
2	GND	Ground ; internally connected to pin 5
3	I	Input voltage
4	Q	Output voltage ; must be blocked by a capacitor $C_Q \geq 1 \mu\text{F}$, $\text{ESR} \leq 10 \Omega$ to GND
5	GND	Ground ; internally connected to pin 2

Functional Block Diagram

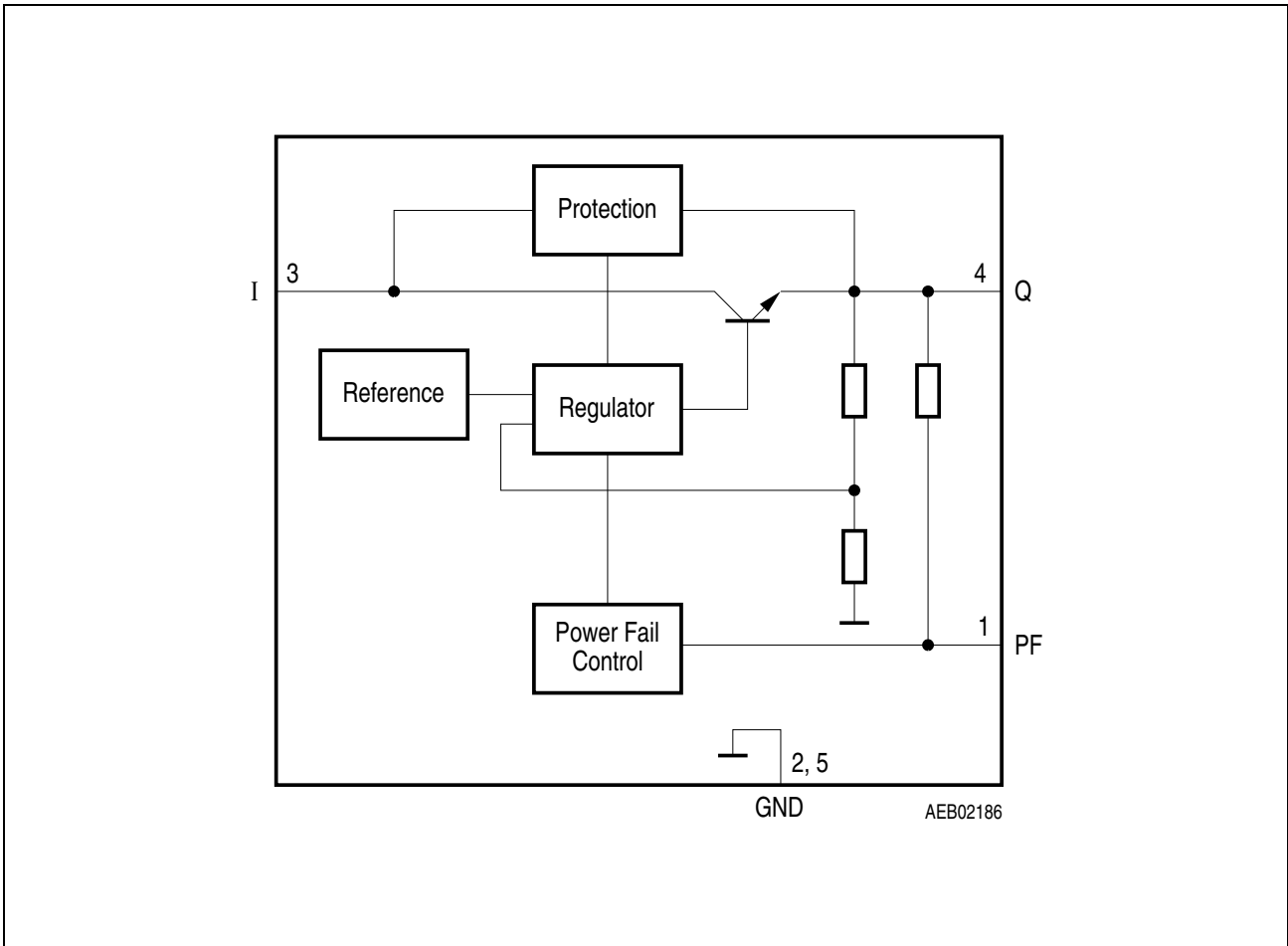

Figure 2 Block Diagram

Table 2 Absolute Maximum Ratings
 $-40\text{ °C} < T_j < 150\text{ °C}$

Parameter	Symbol	Limit Values		Unit	Remarks
		Min.	Max.		
Input					
Voltage	V_I	-0.3	45	V	–
Current	I_I	-20	*	mA	* internally limited
Output					
Voltage	V_Q	-0.3	16	V	–
Current	I_Q	-20	*	mA	* internally limited
Power Fail					
Voltage	V_{PF}	-0.3	45	V	–
Current	I_{PF}	-500	*	μA	* internally limited
Temperatures					
Junction temperature	T_j	-40	150	$^{\circ}\text{C}$	–
Storage temperature	T_{stg}	-50	150	$^{\circ}\text{C}$	–
Thermal Resistances					
Junction pin	$R_{thj-pin}$	–	30	K/W	measured to pin 5
Junction ambient	R_{thj-a}	–	55	K/W	¹⁾

1) Package mounted on PCB $40 \times 40 \times 1.5\text{ mm}^3/6\text{ cm}^2\text{ Cu}$.

Note: Maximum ratings are absolute ratings; exceeding any one of these values may cause irreversible damage to the integrated circuit.

Table 3 Operating Range

Parameter	Symbol	Limit Values		Unit	Remarks
		Min.	Max.		
Input voltage	V_I	6	42	V	–
Output current	I_Q	15	–	mA	–
Junction temperature	T_j	-40	150	$^{\circ}\text{C}$	–

Table 4 Electrical Characteristics
 $6.2\text{ V} < V_I < 36\text{ V}$; $-40\text{ °C} < T_j < 150\text{ °C}$; unless otherwise specified

Parameter	Symbol	Limit Values			Unit	Test Condition
		Min.	Typ.	Max.		
Output						
Output voltage	V_Q	4.85	5.0	5.15	V	$T_j = 25\text{ °C}$; $1\text{ mA} < I_Q < 10\text{ mA}$
Output voltage	V_Q	4.8	5.0	5.20	V	$1\text{ mA} < I_Q < 10\text{ mA}$
Drop voltage	V_{dr}	0.6	0.8	1.1	V	$I_Q = 10\text{ mA}^{1)}$
Output capacitor	C_Q	1	–	–	μF	$\text{ESR} \leq 10\ \Omega$ at 10 kHz
Output current	I_Q	15	–	70	mA	–
Current Consumption						
Quiescent current	I_q	–	100	150	μA	$I_Q < 10\text{ mA}$; $V_I = 13.5\text{ V}$
Regulator Performance						
Load regulation	ΔV_Q	–	5	10	mV	$0\text{ mA} < I_Q < 10\text{ mA}$; $V_I = 6\text{ V}$; $T_j \leq 85\text{ °C}$
Line regulation	ΔV_Q	–	5	10	mV	$I_Q = 5\text{ mA}$; $T_j \leq 85\text{ °C}$
Power supply ripple rejection	$PSRR$	–	60	–	dB	$f_r = 100\text{ Hz}$; $V_r = 0.5\text{ Vpp}$
Power Fail Output						
Power fail switching threshold	ΔV_Q	–	$V_{Q,nom} - 50$	–	mV	$V_{PF} < 1\text{ V}$
Power fail low voltage	$V_{PF,low}$	–	0.15	0.3	V	$I_{PF} = 0.1\text{ mA}$; $V_Q = 4.5\text{ V}$
Power fail leakage current	I_{PFLK}	–	–	10	μA	$R_{ext} = 47\text{ k}\Omega$
Power fail pull-up	R_{PF}	30	50	70	$\text{k}\Omega$	internally connected to V_Q

 1) Measured when the output voltage V_Q has dropped 100 mV from the nominal value.

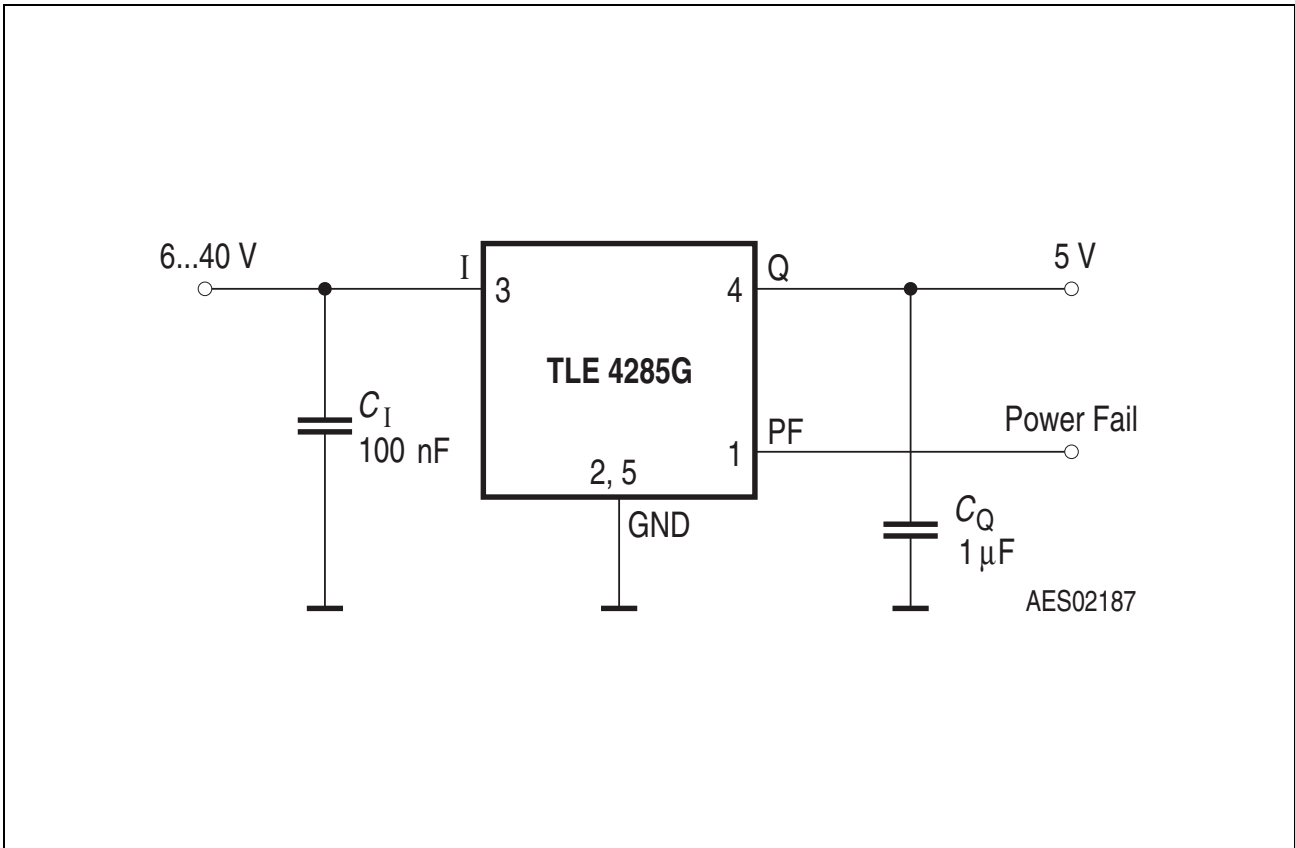
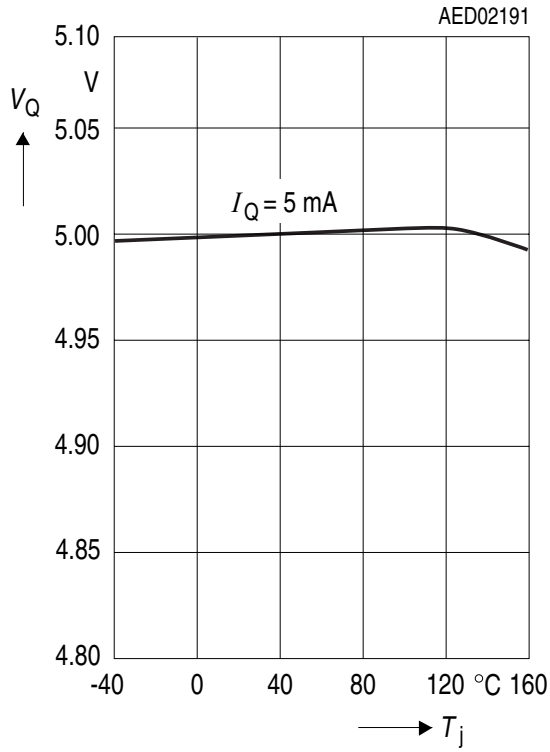

Figure 3 Application Circuit

Typical Performance Characteristics

Output Voltage V_Q versus Temperature T_j



Output Voltage V_Q versus Output Current I_Q

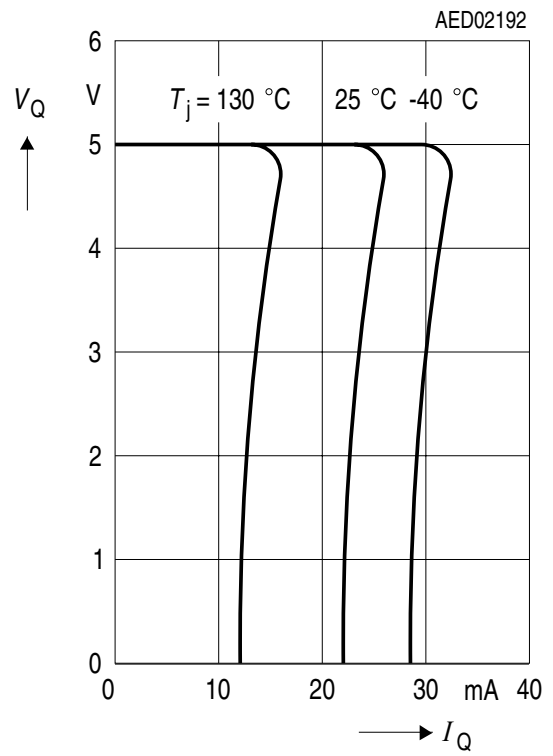

Output Voltage V_Q versus Input Voltage V_I

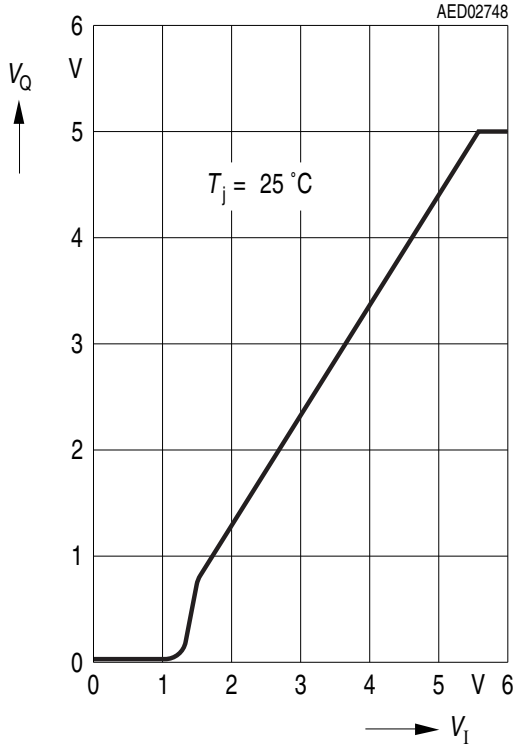

Drop Voltage V_{dr} versus Output Current I_Q

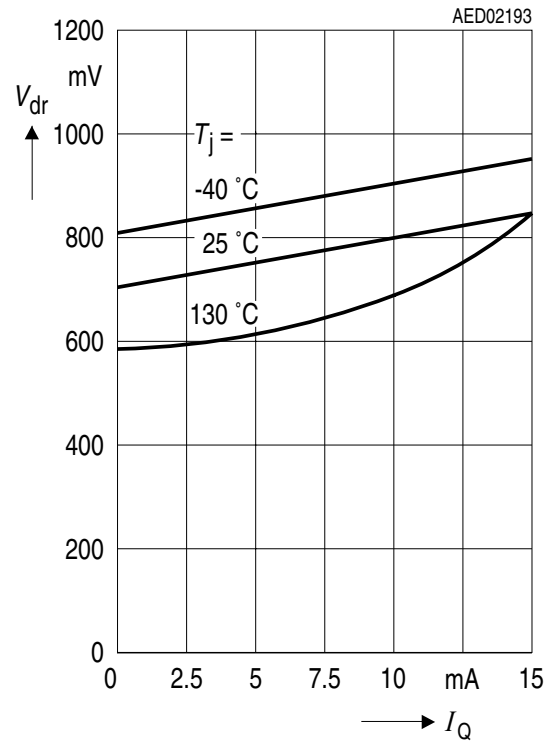

Current Consumption I_q versus Output Current I_Q

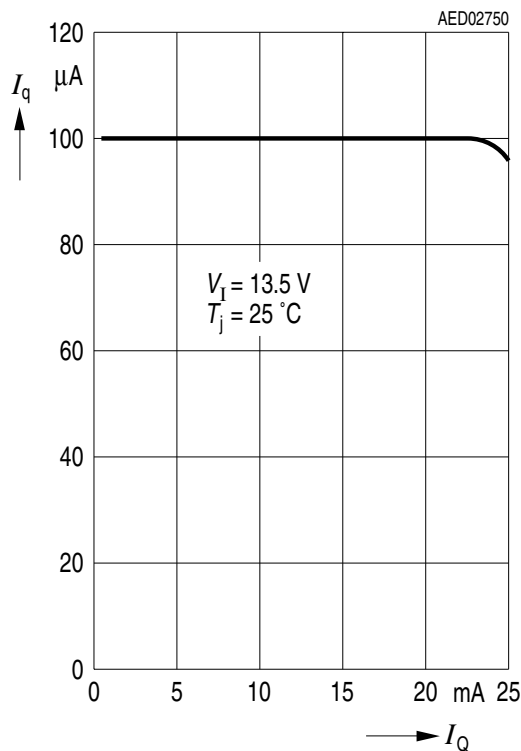

Current Consumption I_q versus Input Voltage V_I

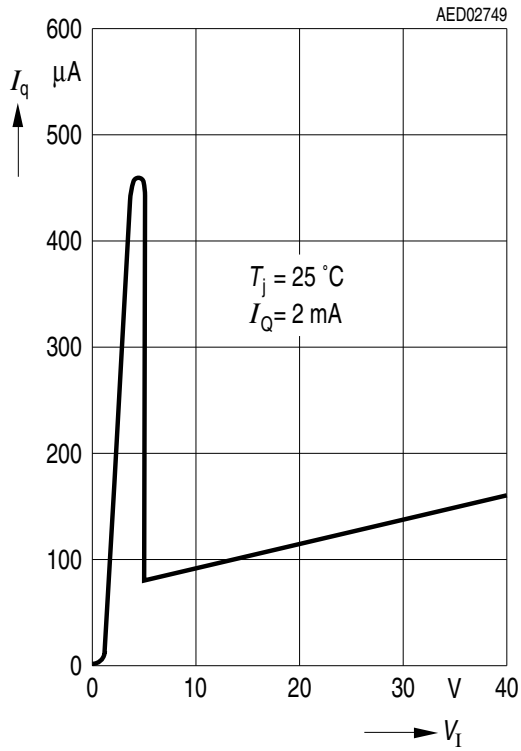

Power Fail Low Voltage V_{PF} versus Power Fail Current I_{PF}

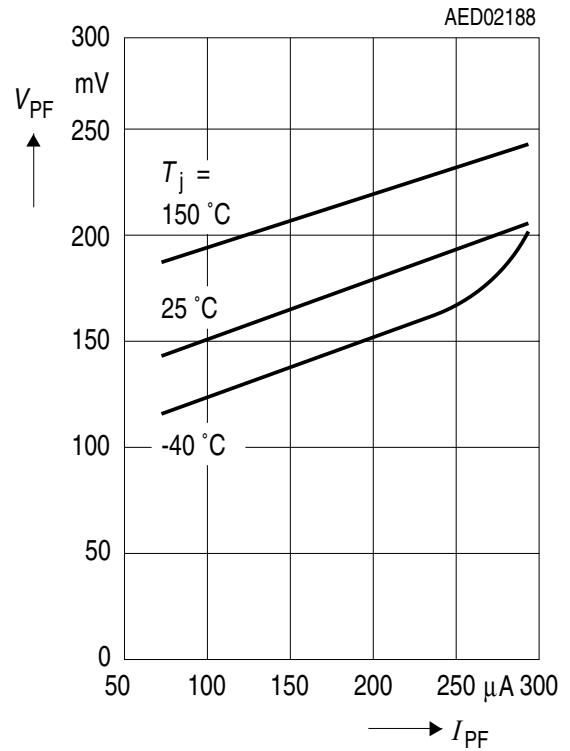

Package Outlines

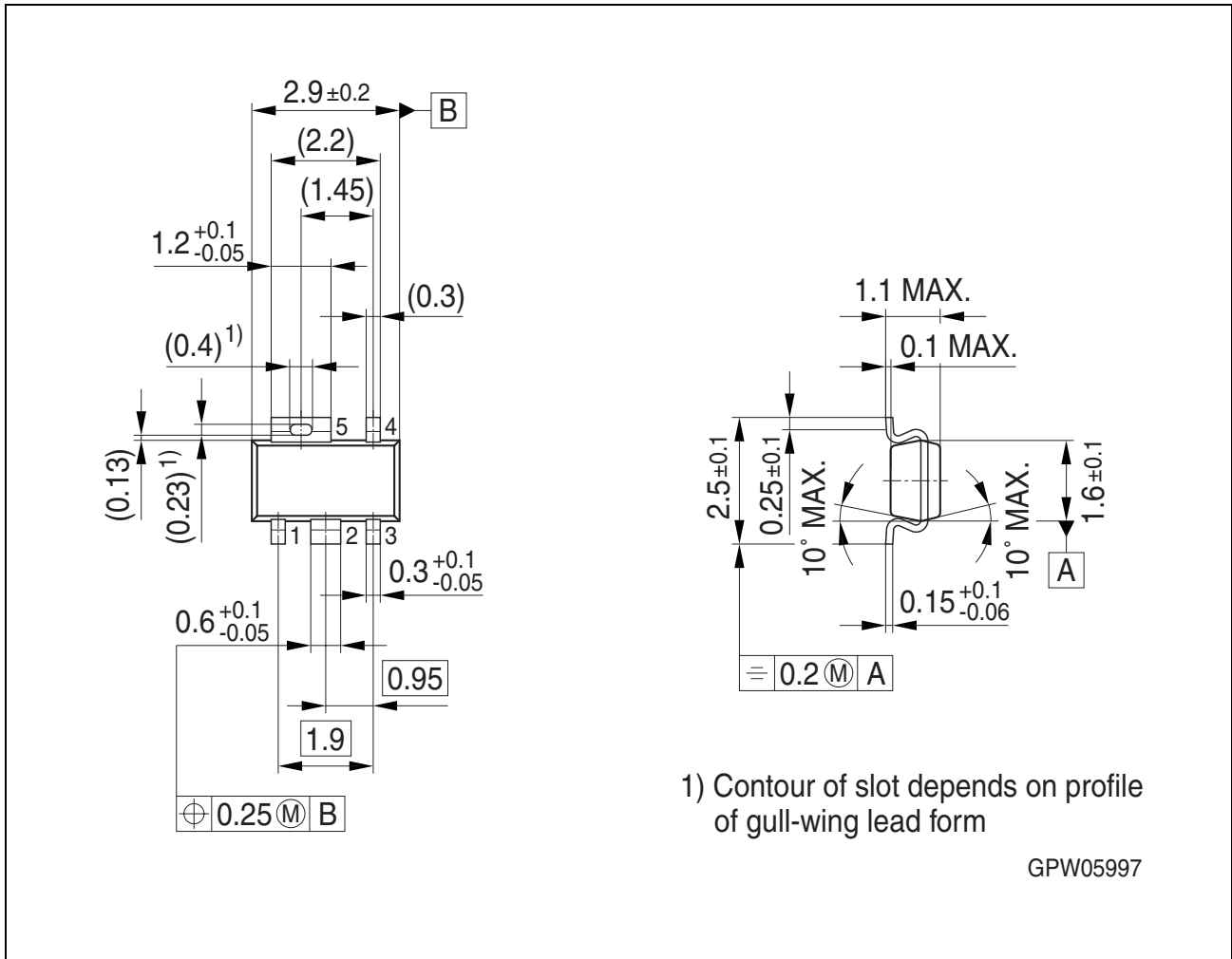

Figure 4 Outline PG-SCT-595-5

Green Product (RoHS compliant)

To meet the world-wide customer requirements for environmentally friendly products and to be compliant with government regulations the device is available as a green product. Green products are RoHS-Compliant (i.e Pb-free finish on leads and suitable for Pb-free soldering according to IPC/JEDEC J-STD-020).

You can find all of our packages, sorts of packing and others in our Infineon Internet Page "Products": <http://www.infineon.com/packages>.

SMD = Surface Mounted Device

Dimensions in mm

Revision History

Version	Date	Changes
Rev. 2.2	2008-04-21	Initial version of RoHS-compliant derivate of TLE 4285 G Page 1 : AEC certified statement added. Page 1 and Page 10 : RoHS compliance statement and Green product feature added. Page 1 and Page 10 : Package changed to RoHS compliant version. Page 1 : Marking information added. Page 1 : Adapted description to values given on Page 5 . Not a change of electrical characteristics. Legal Disclaimer updated.
Rev. 2.1	2004-01-01	Final datasheet

Edition 2008-04-21

**Published by
Infineon Technologies AG
81726 Munich, Germany**

**© 2008 Infineon Technologies AG
All Rights Reserved.**

Legal Disclaimer

The information given in this document shall in no event be regarded as a guarantee of conditions or characteristics. With respect to any examples or hints given herein, any typical values stated herein and/or any information regarding the application of the device, Infineon Technologies hereby disclaims any and all warranties and liabilities of any kind, including without limitation, warranties of non-infringement of intellectual property rights of any third party.

Information

For further information on technology, delivery terms and conditions and prices, please contact the nearest Infineon Technologies Office (www.infineon.com).

Warnings

Due to technical requirements, components may contain dangerous substances. For information on the types in question, please contact the nearest Infineon Technologies Office.

Infineon Technologies components may be used in life-support devices or systems only with the express written approval of Infineon Technologies, if a failure of such components can reasonably be expected to cause the failure of that life-support device or system or to affect the safety or effectiveness of that device or system. Life support devices or systems are intended to be implanted in the human body or to support and/or maintain and sustain and/or protect human life. If they fail, it is reasonable to assume that the health of the user or other persons may be endangered.