

PLEASE CHECK WWW.MOLEX.COM FOR LATEST PART INFORMATION

Part Number: [0340812003](#)
Status: **Active**
Overview: [mx150 sealed connector system](#)
Description: MX150™ Female Cable Seal Terminal, Gold (Au) Plating, 14-16 AWG, Right Reel Payoff, Contact Material Thickness 0.30mm (.012")

Documents:

[Drawing \(PDF\)](#) [RoHS Certificate of Compliance \(PDF\)](#)

General

Product Family	Crimp Terminals
Series	34081
Comments	Right Reel Payoff, Cable Seal
Crimp Quality Equipment	Yes
Overview	mx150 sealed connector system
Product Name	MX150™

Physical

Gender	Female
Material - Metal	High Performance Alloy (HPA)
Material - Plating Mating	Gold
Material - Plating Termination	Tin
Packaging Type	Reel
Plating min: Mating (µin)	30.4
Plating min: Mating (µm)	0.76
Plating min: Termination (µin)	100
Plating min: Termination (µm)	2.5
Termination Interface: Style	Crimp or Compression
Wire Insulation Diameter	2.60mm (.102") max.
Wire Size AWG	14, 16
Wire Size mm²	1.5

Electrical

Current - Maximum per Contact	22A
Voltage - Maximum	250V

Material Info

Reference - Drawing Numbers

Sales Drawing	SD-34083-002
---------------	--------------

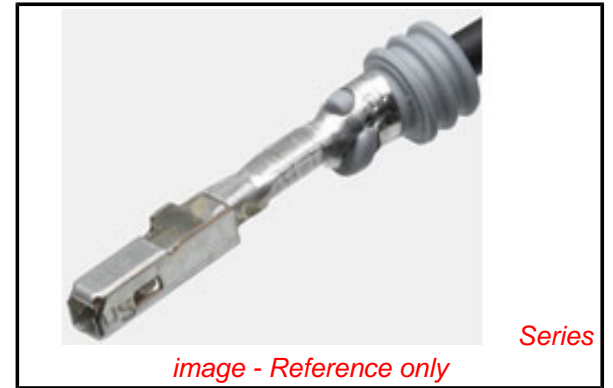

EU RoHS

ELV and RoHS Compliant
REACH SVHC Contains SVHC: No
Halogen-Free Status

China RoHS



Need more information on product environmental compliance?

Email productcompliance@molex.com
 For a multiple part number RoHS Certificate of Compliance, [click here](#)

Please visit the [Contact Us](#) section for any non-product compliance questions.

Search Parts in this Series

[34081Series](#)

Use With

[33471](#) Single Row Sealed Connector, [33472](#) Dual Row Sealed Connector, [34062](#) Single Row Hybrid Sealed Connector, [34250](#) Single Row 2-Way Cable Sealed Connector, [34250](#) Single Row 3-Way Cable Sealed Connector

Application Tooling | FAQ

Tooling specifications and manuals are found by selecting the products below. Crimp Height Specifications are then contained in the Application Tooling Specification document.

Global

Description	Product #
Manual Extraction Tool	0638131500

PLEASE CHECK WWW.MOLEX.COM FOR LATEST PART INFORMATION

STAMP PLATING TYPE (Au-GOLD),
(Sn-TIN) OR (Ag-SILVER) IN THIS AREA

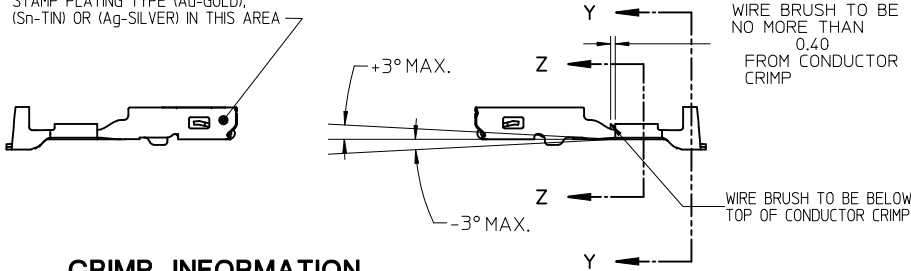

CRIMP INFORMATION
SEE TABLE 1 ON SHEET 2

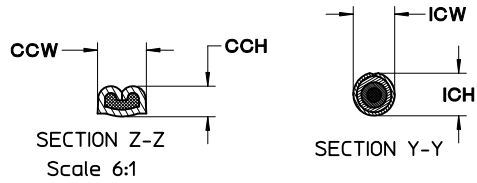

SILVER PLATING:
BASE LAYER:
ELECTRODEPOSITED DUCTILE SULFATE NICKEL
THICKNESS: 1.25 - 2.25 MICROMETERS

SILVER LAYER:
ZONE A1 AND ZONE A2
ELECTRODEPOSITED PURE SILVER (IMPURITIES 0.5% MAX)
FINISH: SEMI-BRIGHT
THICKNESS: 1.9 - 3.3 MICROMETERS

ANTI-TARNISH TREATMENT FOR SILVER PLATED TERMINALS:
EVABRITE WS

ZONE B:
TIN PLATING: PER MOLEX ES-88 REVISION: REL

THICKNESS 1 (1.25 - 2.25 MICROMETERS)
ELECTRODEPOSITED SULFAMATE DUCTILE NICKEL (BASE LAYER)

THICKNESS 2 (2.50 - 4.00 MICROMETERS) ELECTRODEPOSITED
TIN (100% TIN) MATTE FINISH

PLATING NOTES:

1. TIN PLATING: (ENTIRE TERMINAL)

THICKNESS 1 (0.25-1.00 MICROMETERS)
ELECTRODEPOSITED ADVANCED TIN BARRIER (BASE LAYER)

THICKNESS 2 (0.50-1.00 MICROMETERS)
ELECTRODEPOSITED REFLOW TIN (100% TIN, NO BRIGHTENERS)

PLATING INFORMATION

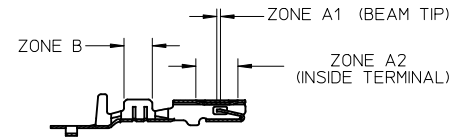

SECTION A-A

GOLD PLATING NOTES:

ZONE A1 AND ZONE A2:
PER MOLEX ES-88 REVISION:REL

THICKNESS 1 (1.25 - 2.25 MICROMETERS)
ELECTRODEPOSITED SULFAMATE DUCTILE NICKEL (BASE LAYER)

THICKNESS 2 (0.76 MICROMETERS MINIMUM)
ELECTRODEPOSITED GOLD CAP

ZONE B:
TIN PLATING: PER MOLEX ES-88 REVISION:REL

THICKNESS 1 (1.25-2.25 MICROMETERS)
ELECTRODEPOSITED SULFAMATE DUCTILE NICKEL (BASE LAYER)

THICKNESS 2 (2.50 - 4.00 MICROMETERS) ELECTRODEPOSITED
TIN (100% TIN) MATTE FINISH

NOTES: (UNLESS OTHERWISE SPECIFIED)

- MATING TERMINAL SHOWN ON MOLEX DRAWING SD-34080-001
- MATERIAL: ASTM B422, UNS C19025, HR04
THICKNESS: 0.30 mm +0.01
TEMPER: FULL HARD (REF)
TENSILE: 496 MIN MPA
PLATING: SEE PLATING NOTES
- MEETS PERFORMANCE SPECIFICATION FOR CABLE TO TERMINAL
ELECTRICAL CRIMPS PER SAE/USCAR-21 (8/2001)
- MEETS PERFORMANCE STANDARD FOR AUTOMOTIVE ELECTRICAL
CONNECTOR SYSTEMS FOR SAE/USCAR-2, REV. 4 (TEMP CLASS 3)
(4/2001)
- MEETS ELECTRICAL CONNECTION SYSTEM DESIGN SPECIFICATION
(SDS) REV.11 (5/2002)
- MEETS FIELD CORRELATED LIFE TEST (FCLT) PER
SAE/USCAR-20 (11/2001)

- INSERTION FORCE WITH INLINE BLADE
AVG FROM PV TESTING = 3.5 N TIN (REFERENCE)
3.1 N GOLD (REFERENCE)
- REFERENCE PK-31300-516 FOR REEL DIRECTION
- REFERENCE CS-34083-002 FOR ADDITIONAL
CRIMP INFORMATION

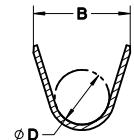

SECTION B-B
Scale 5:1

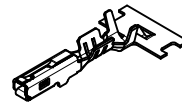
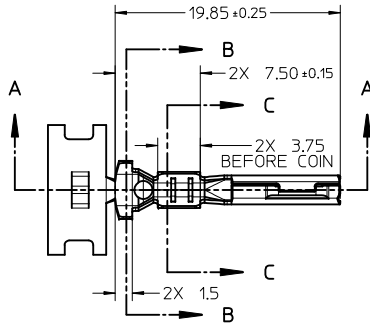

SCALE 2:1

SEE TABLE 2 ON SHEET 3
FOR CHARTED DIM.

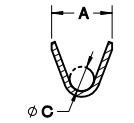

SECTION C-C
Scale 5:1

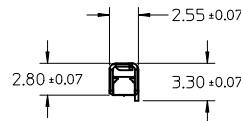
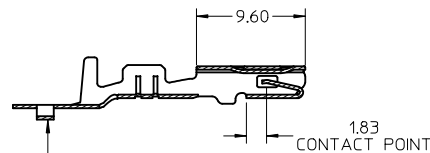

SECTION A-A

CARRIER BUMP DIRECTION
POINTS DOWN FOR TIN PLATED TERMINALS
POINTS UP FOR PRECIOUS PLATED TERMINALS

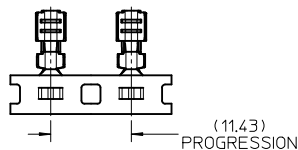

ENTER DESCRIPTION IEC NO: UAU2010-0419 DRW:KFERGUSON CHKD:A.DHIR APPR:BMOSER 2009/12/02 2009/12/02	QUALITY SYMBOLS ▽=0 ▽=0	GENERAL TOLERANCES (UNLESS SPECIFIED)	DIMENSION STYLE MM ONLY	SCALE 3:1	DESIGN UNITS METRIC	THIRD ANGLE PROJECTION	
	mm INCH	DRAWN BY K.FERGUSON	DATE 4/14/2009	TITLE MX 150 RECEPTACLE CABLE SEAL			
	4 PLACES ± --- ± --- 3 PLACES ± --- ± --- 2 PLACES ± 0.10 ± --- 1 PLACE ± 0.3 ± ---	CHECKED BY A. DHIR	DATE 4/14/2009	MOLEX INCORPORATED			
	ANGULAR ± 3 °	APPROVED BY B. MOSER	DATE 4/14/2009	MATERIAL NO. SEE TABLE	DOCUMENT NO. SD-34083-002	SHEET NO. 1 OF 3	

DRAFT WHERE APPLICABLE
MUST REMAIN
WITHIN DIMENSIONS

THIS DRAWING CONTAINS INFORMATION THAT IS PROPRIETARY TO MOLEX
INCORPORATED AND SHOULD NOT BE USED WITHOUT WRITTEN PERMISSION

TABLE 1 – TERMINAL CRIMP DIMENSION REFERENCE TABLE

SUPPLIER PART NO.	PLATING	WIRE SIZE (awg)	WIRE SPECIFICATION	CONDUCTOR CCH (SEC Z-Z) ±0.05	CONDUCTOR CCW (SEC Z-Z) ±0.10	INSULATOR ICH (SEC Y-Y) ±0.10	INSULATOR ICW (SEC Y-Y) ±0.10	WIRE PULL FORCE (N)	OSR CABLE SEAL PART NO.	YAZAKI CABLE SEAL PART NO.	
RIGHT PAYOFF	LEFT PAYOFF										
34083-2001	34083-3001	TIN	14	MIL-123A	1.65	2.45	3.95	3.65	268	-	7158-3033-40
			14	MIL-135A1	1.65	2.45	3.80	3.65	268	E-1644-02	-
			16	MIL-123A	1.35	2.45	3.80	3.65	222	E-1644-02	-
34083-2002	34083-3002	TIN	18	MIL-123A	1.25	2.15	3.70	3.55	157	E-1644-00	-
			18	SAE J1128 (GXL)	1.25	2.15	3.90	3.55	157	E-1644-02	-
			20	MIL-123A	1.15	2.15	3.60	3.55	128	E-1644-00	-
			20	SAE J1128 (GXL)	1.15	2.15	3.80	3.55	128	E-1644-02	-
34083-2003	34083-3003	TIN	22	MIL-123A	1.00	1.60	3.50	3.45	88	E-1644-01	-
34083-2001	34083-3001	TIN	2.00mm ²	JASO D 611(AVSS)	1.60	2.45	3.95	3.65	268	-	7158-3033-40
34083-2001	34083-3001	TIN	1.50mm ²	MIL-126A1	1.40	2.45	3.80	3.65	257	E-1644-02	-
34083-2002	34083-3002	TIN	1.0mm ²	MIL-126A1	1.30	2.15	3.70	3.55	211	E-1644-00	-
34083-2002	34083-3002	TIN	0.75mm ²	MIL-126A1	1.25	2.15	3.60	3.55	142	E-1644-00	-
34083-2003	34083-3003	TIN	0.50mm ²	MIL-126A1	1.10	1.60	3.50	3.45	111	E-1644-01	-
34083-2003	34083-3003	TIN	0.50mm ²	JASO D 611(AVSS)	1.10	1.60	3.50	3.45	111	E-1644-01	-
34081-2003	34081-3003	GOLD	14	MIL-123A	1.65	2.45	3.95	3.65	268	-	7158-3033-40
			14	MIL-135A1	1.65	2.45	3.80	3.65	268	E-1644-02	-
			16	MIL-123A	1.35	2.45	3.80	3.65	222	E-1644-02	-
34081-2004	34081-3004	GOLD	18	MIL-123A	1.25	2.15	3.70	3.55	157	E-1644-00	-
			18	SAE J1128 (GXL)	1.25	2.15	3.90	3.55	157	E-1644-02	-
			20	MIL-123A	1.15	2.15	3.60	3.55	128	E-1644-00	-
			20	SAE J1128 (GXL)	1.15	2.15	3.80	3.55	128	E-1644-02	-
34081-2005	34081-3005	GOLD	22	MIL-123A	1.00	1.60	3.50	3.45	88	E-1644-01	-
34081-2003	34081-3003	GOLD	2.00mm ²	JASO D 611(AVSS)	1.60	2.45	3.95	3.65	268	-	7158-3033-40
34081-2003	34081-3003	GOLD	1.50mm ²	MIL-126A1	1.40	2.45	3.80	3.65	257	E-1644-02	-
34081-2004	34081-3004	GOLD	1.0mm ²	MIL-126A1	1.30	2.15	3.70	3.55	211	E-1644-00	-
			0.75mm ²	MIL-126A1	1.25	2.15	3.60	3.55	142	E-1644-00	-
			0.50mm ²	MIL-126A1	1.10	1.60	3.50	3.45	111	E-1644-01	-
34081-2005	34081-3005	GOLD	0.50mm ²	JASO D 611(AVSS)	1.10	1.60	3.50	3.45	111	E-1644-01	-
34081-4001	34081-5001	SILVER	14	MIL-123A	1.65	2.45	3.95	3.65	268	-	7158-3033-40
			14	MIL-135A1	1.65	2.45	3.80	3.65	268	E-1644-02	-
			16	MIL-123A	1.35	2.45	3.80	3.65	222	E-1644-02	-
34081-4002	34081-5002	SILVER	18	MIL-123A	1.25	2.15	3.70	3.55	157	E-1644-00	-
			18	SAE J1128 (GXL)	1.25	2.15	3.90	3.55	157	E-1644-02	-
			20	MIL-123A	1.15	2.15	3.60	3.55	128	E-1644-00	-
			20	SAE J1128 (GXL)	1.15	2.15	3.80	3.55	128	E-1644-02	-
34081-4003	34081-5003	SILVER	22	MIL-123A	1.00	1.60	3.50	3.45	88	E-1644-01	-
34081-4001	34081-5001	SILVER	2.00mm ²	JASO D 611(AVSS)	1.60	2.45	3.95	3.65	268	-	7158-3033-40
34081-4001	34081-5001	SILVER	1.50mm ²	MIL-126A1	1.40	2.45	3.80	3.65	257	E-1644-02	-
34081-4002	34081-5002	SILVER	1.0mm ²	MIL-126A1	1.30	2.15	3.70	3.55	211	E-1644-00	-
			0.75mm ²	MIL-126A1	1.25	2.15	3.60	3.55	142	E-1644-00	-
			0.50mm ²	MIL-126A1	1.10	1.60	3.50	3.45	111	E-1644-01	-
34081-4003	34081-5003	SILVER	0.50mm ²	JASO D 611(AVSS)	1.10	1.60	3.50	3.45	111	E-1644-01	-

ENTER DESCRIPTION IEC NO. UAU2010-0419 DRAWN BY K. FERGUSON CHECKED BY CHIKKA, DHIR APPR. BY MOSER DATE 2009/12/02 REV DESCRIPTION 2009/12/02	QUALITY SYMBOLS ▽=0 ▽=0		GENERAL TOLERANCES (UNLESS SPECIFIED) DIM INCH 4 PLACES ± .005 3 PLACES ± .004 2 PLACES ± 0.10 1 PLACE ± 0.3 ANGULAR ± 3°		DIMENSION STYLE MM ONLY		SCALE METRIC	DESIGN UNITS METRIC	THIRD ANGLE PROJECTION
	DRAFT WHERE APPLICABLE MUST REMAIN WITHIN DIMENSIONS		DRAWN BY DATE K. FERGUSON 4/14/2009		CHECKED BY DATE A. DHIR 4/14/2009		APPROVED BY DATE B. MOSER 4/14/2009		TITLE MX 150 RECEPTACLE CABLE SEAL
	MATERIAL NO. SEE TABLE		DOCUMENT NO. SD-34083-002		MOLEX INCORPORATED		SHEET NO. 2 OF 3		THIS DRAWING CONTAINS INFORMATION THAT IS PROPRIETARY TO MOLEX INCORPORATED AND SHOULD NOT BE USED WITHOUT WRITTEN PERMISSION
	SIZE D		SEE TABLE		MOLEX INCORPORATED		SHEET NO. 2 OF 3		THIS DRAWING CONTAINS INFORMATION THAT IS PROPRIETARY TO MOLEX INCORPORATED AND SHOULD NOT BE USED WITHOUT WRITTEN PERMISSION

CRIMP TOOL INFORMATION
SEE TABLE 2 FOR TABLED DIMENSIONS

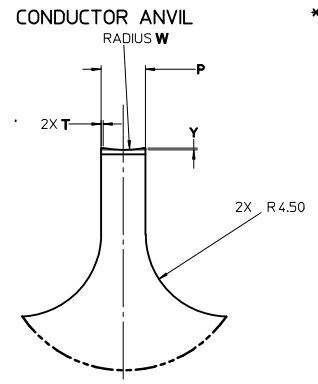
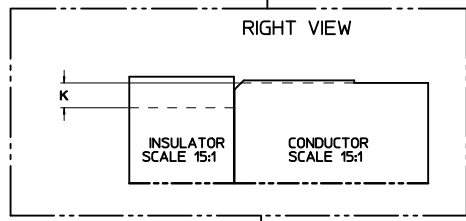
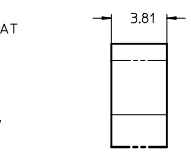
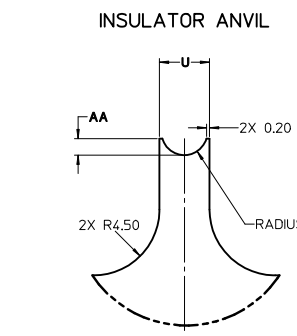
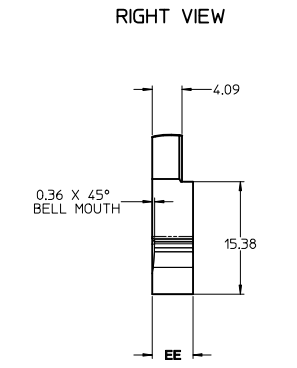
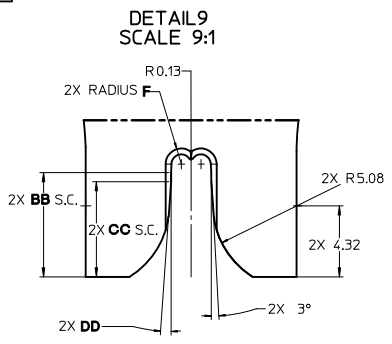
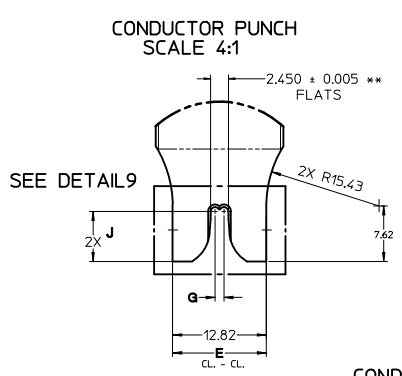
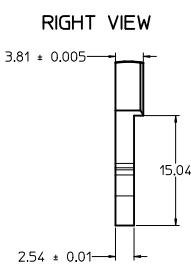
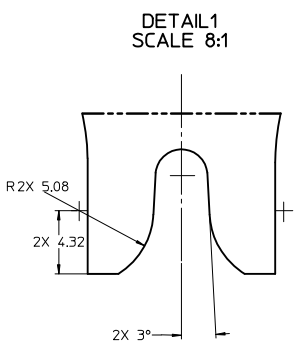
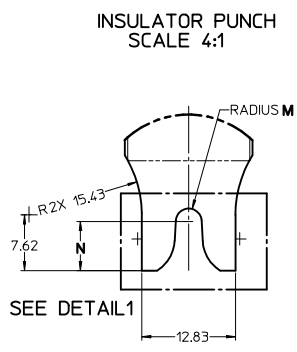

** 14-16 AWG, 150mm² & 2.0mm² ONLY

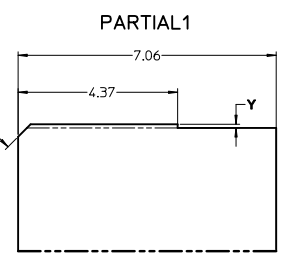

TABLE 2 - TERMINAL GRIP/CRIMP TOOL DIMENSION REFERENCE TABLE

SUPPLIER PART NUMBER		PLATING (STAMPING)	WIRE APPLICATION		A	B	C	D	E	F	G	J	K	M	N	P	T	U	V	W	Y	AA	BB	CC	DD	EE
RIGHT PAYOFF	LEFT PAYOFF		SAE (AWG)	METRIC (mm ²)	+0.3	+0.20	+0.3	+0.15	+0.01	+0.005	+0.005	+0.05	+0.01	+0.005	+0.10	+0.005	+0.03	+0.005	+0.005	+0.10	+0.01	+0.10	+0.01	+0.01	+0.01	±P
34083-2001	34083-3001	TIN	14	2.0	3.6	5.00	1.7	2.90	12.82	0.600	1.194	6.86	0.90	1.778	6.73	2.438	0.12	3.429	1.575	6.11	0.10	1.13	6.34	5.79	4°	5.59
			16	1.5	3.6	5.00	1.7	2.90	12.82	0.600	1.194	6.86	0.90	1.778	6.73	2.438	0.12	3.429	1.575	6.11	0.10	1.13	6.34	5.79	4°	5.59
34083-2002	34083-3002	TIN	18	1.0	3.3	5.00	1.3	2.90	12.57	0.556	0.963	7.34	0.70	1.753	6.73	2.085	0.33	3.378	1.699	1.94	0.14	0.88	-	-	-	3.81
			20	0.75	3.3	5.00	1.3	2.90	12.57	0.556	0.963	7.34	0.70	1.753	6.73	2.085	0.33	3.378	1.699	1.94	0.14	0.88	-	-	-	3.81
34083-2003	34083-3003	TIN	22	0.5	2.5	4.85	0.9	2.90	11.92	0.414	0.714	6.27	0.55	1.737	7.06	1.576	0.26	3.327	1.524	2.00	0.07	1.08	-	-	-	3.81
34081-2003	34081-3003	GOLD	14	2.0	3.6	5.00	1.7	2.90	12.82	0.600	1.194	6.86	0.90	1.778	6.73	2.438	0.12	3.429	1.575	6.11	0.10	1.13	6.34	5.79	4°	5.59
			16	1.5	3.6	5.00	1.7	2.90	12.82	0.600	1.194	6.86	0.90	1.778	6.73	2.438	0.12	3.429	1.575	6.11	0.10	1.13	6.34	5.79	4°	5.59
34081-2004	34081-3004	GOLD	18	1.0	3.3	5.00	1.3	2.90	12.57	0.556	0.963	7.34	0.70	1.753	6.73	2.085	0.33	3.378	1.699	1.94	0.14	0.88	-	-	-	3.81
			20	0.75	3.3	5.00	1.3	2.90	12.57	0.556	0.963	7.34	0.70	1.753	6.73	2.085	0.33	3.378	1.699	1.94	0.14	0.88	-	-	-	3.81
34081-2005	34081-3005	GOLD	22	0.5	2.5	4.85	0.9	2.90	11.92	0.414	0.714	6.27	0.55	1.737	7.06	1.576	0.26	3.327	1.524	2.00	0.07	1.08	-	-	-	3.81
			14	2.0	3.6	5.00	1.7	2.90	12.82	0.600	1.194	6.86	0.90	1.778	6.73	2.438	0.12	3.429	1.575	6.11	0.10	1.13	6.34	5.79	4°	5.59
34081-4001	34081-5001	SILVER	16	1.5	3.6	5.00	1.7	2.90	12.82	0.600	1.194	6.86	0.90	1.778	6.73	2.438	0.12	3.429	1.575	6.11	0.10	1.13	6.34	5.79	4°	5.59
			18	1.0	3.3	5.00	1.3	2.90	12.57	0.556	0.963	7.34	0.70	1.753	6.73	2.085	0.33	3.378	1.699	1.94	0.14	0.88	-	-	-	3.81
34081-4002	34081-5002	SILVER	20	0.75	3.3	5.00	1.3	2.90	12.57	0.556	0.963	7.34	0.70	1.753	6.73	2.085	0.33	3.378	1.699	1.94	0.14	0.88	-	-	-	3.81
			22	0.5	2.5	4.85	0.9	2.90	11.92	0.414	0.714	6.27	0.55	1.737	7.06	1.576	0.26	3.327	1.524	2.00	0.07	1.08	-	-	-	3.81

ENTER DESCRIPTION EC NO. 141/2010-04-9 DR. DWAN FERGUSON 2009/12/02 CHK'D BY A. DHIR 2009/04/15 APPR'D BY B. MOSELER 2009/04/15 A5	QUALITY SYMBOLS 0 1	GENERAL TOLERANCES (UNLESS SPECIFIED) mm INCH 4 PLACES ± --- ± --- 3 PLACES ± --- ± --- 2 PLACES ± 0.10 ± --- 1 PLACE ± 0.3 ± --- ANGULAR ± 3°	DIMENSION STYLE MM ONLY SCALE 1:1 DESIGN UNITS METRIC THIRD ANGLE PROJECTION	DRAWN BY DATE K. FERGUSON 4/14/2009 CHECKED BY DATE A. DHIR 4/14/2009 APPROVED BY DATE B. MOSELER 4/14/2009	TITLE MX 150 RECEPTACLE CABLE SEAL
	MATERIAL NO. SEE TABLE	DOCUMENT NO. SD-34083-002	SHEET NO. 3 OF 3	Molex MOLEX INCORPORATED	THIS DRAWING CONTAINS INFORMATION THAT IS PROPRIETARY TO MOLEX INCORPORATED AND SHOULD NOT BE USED WITHOUT WRITTEN PERMISSION
	DRAFT WHERE APPLICABLE MUST REMAIN WITHIN DIMENSIONS	SIZE	SEE TABLE	MOLEX MOLEX INCORPORATED	THIS DRAWING CONTAINS INFORMATION THAT IS PROPRIETARY TO MOLEX INCORPORATED AND SHOULD NOT BE USED WITHOUT WRITTEN PERMISSION
	DRAFT WHERE APPLICABLE MUST REMAIN WITHIN DIMENSIONS	SIZE	SEE TABLE	MOLEX MOLEX INCORPORATED	THIS DRAWING CONTAINS INFORMATION THAT IS PROPRIETARY TO MOLEX INCORPORATED AND SHOULD NOT BE USED WITHOUT WRITTEN PERMISSION
	DRAFT WHERE APPLICABLE MUST REMAIN WITHIN DIMENSIONS	SIZE	SEE TABLE	MOLEX MOLEX INCORPORATED	THIS DRAWING CONTAINS INFORMATION THAT IS PROPRIETARY TO MOLEX INCORPORATED AND SHOULD NOT BE USED WITHOUT WRITTEN PERMISSION