

General-purpose grade

Applications

- Uninterruptible power supplies
- Frequency converters
- Professional power supplies

Features

- Compact, i. e. high CU product
- High reliability and ripple current capability
- All-welded construction ensures reliable electrical contact
- Version with optimized construction for base cooling (2-pad solution) available
- Version with low-inductance design available
- Self-extinguishing electrolyt

Construction

- Charge-discharge proof, polar
- Aluminum case with insulating sleeve
- Poles with screw terminal connections
- Mounting with ring clips, clamps or threaded stud
- The bases of types with threaded stud and $d \leq 76,9$ mm are not insulated, types with $d = 91$ mm have fully insulated bases

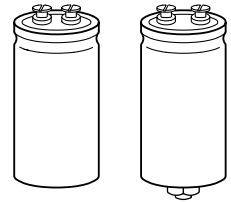

B43455

KAL0567-B

B43457

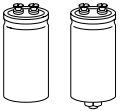

B43455 / B43457

Standard – 85 °C

Specifications and characteristics in brief

Rated voltage U_R	350 ... 450 VDC	
Surge voltage U_S	$1,10 \cdot U_R$ (for $U_R \geq 350$ VDC)	
Rated capacitance C_R	470 ... 12 000 μ F	
Capacitance tolerance	$\pm 20 \% \triangleq M$	
Leakage current I_L (5 min, 20 °C)	$I_L \leq 0,3 \mu A \cdot \left(\frac{C_R}{\mu F} \cdot \frac{U_R}{V} \right)^{0,7} + 4 \mu A$	
Self-inductance ESL	Approx. 20 nH Capacitors with low-inductance design: $d \geq 64,3$ mm: approx. 13 nH	
Useful life 85 °C; U_R ; $I_{\sim R}$ 40 °C; U_R ; $1,5 \cdot I_{\sim R}$	> 10 000 h > 200 000 h	Requirements: $\Delta C/C \leq \pm 30 \%$ of initial value $ESR \leq 3$ times initial specified limit $I_L \leq$ initial specified limit Failure percentage: $\leq 1 \%$ Failure rate: ≤ 40 fit ($\leq 40 \cdot 10^{-9}/h$) (for definition "fit", refer to chapter "Quality", page 62)
Voltage endurance test 85 °C; U_R	2 000 h	Post test requirements: $\Delta C/C \leq \pm 10 \%$ of initial value $ESR \leq 1,3$ times initial specified limit $I_L \leq$ initial specified limit
Vibration resistance	To IEC 60068-2-6, test Fc: displacement amplitude 0,75 mm, frequency range 10 to 55 Hz, acceleration max. 10 g, duration 3×2 h	
IEC climatic category	To IEC 60068-1: 25/085/56 (– 25 °C/+ 85 °C/56 days damp heat test)	
Detail specifications	Similar to CECC 30301-803, CECC 30301-807	
Sectional specification	IEC 60384-4	

Ripple current capability

Due to the ripple current capability of the contact elements, the following current upper limits must not be exceeded:

Capacitor diameter	51,6 mm	64,3 mm	76,9 mm	91,0 mm
$I_{\sim max}$	30 A	40 A	50 A	70 A

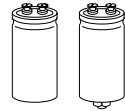
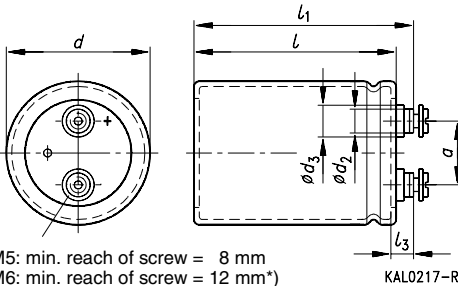
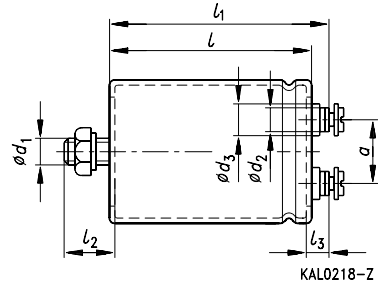
Dimensional drawings
Type B43455
 Ring clip/clamp mounting

Type B43457
 Threaded stud mounting

M5: min. reach of screw = 8 mm
 M6: min. reach of screw = 12 mm*)
 *) 8 mm for low-inductance design

Positive pole marking: +

The base of types with threaded stud and $d = 91$ mm is fully insulated (the lengths l and l_1 are increased by 0,5 mm in these cases). For types with threaded stud and $d \leq 76$ mm the base is not insulated. Also refer to the notes on mounting given on page 168.

Screw terminals with UNF threads are available upon request.

Dimensions and weights

Ter- minal	Dimensions (mm) with insulating sleeve										Approx. wt. (g)
	d	$l \pm 1$	$l_1 \pm 1$	$l_2 \begin{smallmatrix} +0 \\ -1 \end{smallmatrix}$	l_3	d_1	d_2 max	d_3 max	$a \begin{smallmatrix} +0,2 \\ -0,4 \end{smallmatrix}$		
M 5	51,6 +0/-0,8	80,7	87,2	17	7,0 +0,2/-1	M 12	8,2	13,5	22,2	220	
M 5	51,6 +0/-0,8	105,7	112,2	17	7,0 +0,2/-1	M 12	8,2	13,5	22,2	280	
M 5	64,3 +0/-0,8	105,7	112,2	17	7,0 +0,2/-1	M 12	8,2	13,5	28,5	440	
M 6	76,9 +0/-0,7	105,7	111,5	17	6,4 +1,1/-0,8	M 12	17,7	17,7	31,7	540	
M 6	76,9 +0/-0,7	143,2	149,0	17	6,4 +1,1/-0,8	M 12	17,7	17,7	31,7	840	
M 6	76,9 +0/-0,7	220,7	226,5	17	6,4 +1,1/-0,8	M 12	17,7	17,7	31,7	1300	
M 6	91,0 +0/-2	97,0	103,3	17	6,4 +1,1/-0,8	M 12	17,7	17,7	31,7	750	
M 6	91,0 +0/-2	144,5	149,8	17	6,4 +1,1/-0,8	M 12	17,7	17,7	31,7	1200	
M 6	91,0 +0/-2	191,0	196,3	17	6,4 +1,1/-0,8	M 12	17,7	17,7	31,7	1700	
M 6	91,0 +0/-2	221,0	226,3	17	6,4 +1,1/-0,8	M 12	17,7	17,7	31,7	1900	

Dimensions are also valid for 2-pad solution and low-inductance design.

Packing

For ecological reasons the packing is pure cardboard.

Capacitor diameter d	Packing units (pieces)	Capacitor diameter d	Packing units (pieces)
51,6 mm	22	76,9 mm	12
64,3 mm	15	91,0 mm	8

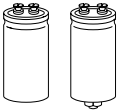

B43455 / B43457

Standard – 85 °C

Special designs

- Low-inductance design
- 2-pad solution

Design for optimized connection of the capacitor to the heatsink when using base cooling. This version is available for capacitors without threaded stud and for diameters $\geq 64,3$ mm (cf. $I_{-R}(B)$ in table “Technical data and ordering codes” and useful life graphs).

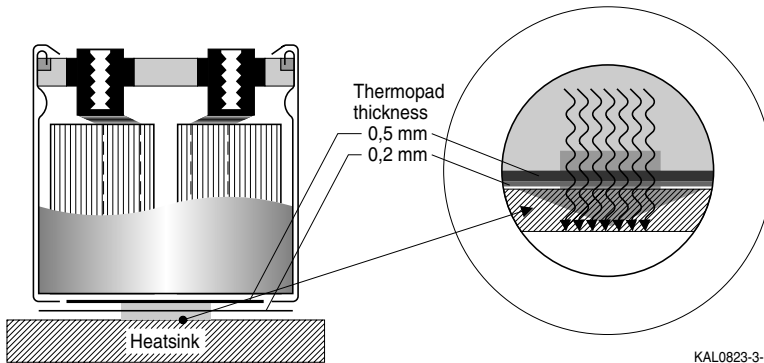

KAL0823-3-E

Ordering codes:

Design	Identification in 3rd block of ordering code	Remark
Low inductance (13 nH)	M003	For capacitors with diameter $d \geq 64,3$ mm
2-pad solution	M006	For capacitors with diameter $d \geq 64,3$ mm and without threaded stud

Accessories

The following items are included in the delivery package, but are not fastened to the capacitors:

	Thread	Toothed washers	Screws/Nuts	Maximum torque
For terminals	M 5	A 5,1 DIN 6797	Cylinder-head screw M 5 \times 8 DIN 84-4.8	2 Nm
	M 6	A 6,4 DIN 6797	Cylinder-head screw M 6 \times 12 DIN 85-4.8	2,5 Nm
For mounting	M 12	J 12,5 DIN 6797	Hex nut BM 12 DIN 439	10 Nm

The following must be ordered separately:

Ring clips

B44030 (cf. page 169)

Clamps for capacitors with $d \geq 64,3$ mm

B44030 (cf. page 173)

Insulating parts

B44020 (cf. page 166)

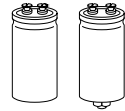
Overview of available types

U_R (VDC)	350	400	450
C_R (μF)	Case dimensions $d \times l$ (mm)		
470			51,6 × 80,7
1 000	51,6 × 80,7	51,6 × 80,7	51,6 × 80,7
1 500	51,6 × 105,7	51,6 × 105,7	64,3 × 105,7
2 200	51,6 × 105,7	64,3 × 105,7	64,3 × 105,7
3 300	64,3 × 105,7	76,9 × 105,7	76,9 × 143,2
4 700	76,9 × 105,7	76,9 × 143,2 91,0 × 97,0	76,9 × 220,7 91,0 × 144,5
6 000	76,9 × 143,2	76,9 × 220,7	76,9 × 220,7
6 800	76,9 × 143,2	91,0 × 144,5	
8 200	91,0 × 144,5		91,0 × 221,0
10 000	91,0 × 144,5	91,0 × 191,0	
12 000	91,0 × 191,0	91,0 × 221,0	

The capacitance and voltage ratings listed above are available in different cases upon request. Other voltage and capacitance ratings are also available upon request.

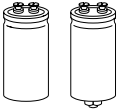
B43455 / B43457
Standard – 85 °C
Technical data and ordering codes

U_R	C_R	Case dimensions	ESR_{max}	Z_{max}	$I_{~max}$	$I_{~max}$	$I_{~R}$	$I_{~R(B)}$	Ordering code ¹⁾
VDC	100 Hz 20 °C μF	$d \times l$ mm	100 Hz 20 °C mΩ	10 kHz 20 °C mΩ	100 Hz 40 °C A	100 Hz 85 °C A	100 Hz 85 °C A	100 Hz 85 °C A	
350	1 000	51,6 × 80,7	129	140	13	5,4	4,5	7,8	B4345*A4108M000
	1 500	51,6 × 105,7	93	110	16	7,0	5,8	9,2	B4345*A4158M000
	2 200	51,6 × 105,7	72	63	20	8,5	7,1	13	B4345*B4228M000
	3 300	64,3 × 105,7	48	43	23	9,8	8,2	14	B4345*B4338M000 ²⁾
	4 700	76,9 × 105,7	38	35	28	12	10	19	B4345*B4478M000 ²⁾
	6 000	76,9 × 143,2	32	30	32	14	12	19	B4345*A4608M000 ²⁾
	6 800	76,9 × 143,2	27	27	36	16	13	22	B4345*A4688M000 ²⁾
	8 200	91,0 × 144,5	23	23	42	18	15	26	B4345*A4828M000 ²⁾
	10 000	91,0 × 144,5	20	22	48	21	17	31	B4345*B4109M000 ²⁾
	12 000	91,0 × 191,0	17	21	54	23	20	30	B4345*A4129M000 ²⁾
	400	1 000	51,6 × 80,7	129	140	13	5,2	4,8	8,9
1 500		51,6 × 105,7	93	110	17	6,8	6,2	11	B4345*A9158M000
2 200		64,3 × 105,7	72	63	21	8,4	7,6	13	B4345*A0228M000 ²⁾
3 300		76,9 × 105,7	54	48	23	8,5	8,5	16	B4345*A0338M000 ²⁾
4 700		76,9 × 143,2	41	37	29	11	11	17	B4345*A0478M000 ²⁾
4 700		91,0 × 97,0	41	37	30	13	11	23	B4345*K0478M000 ²⁾
6 000		76,9 × 220,7	32	30	35	15	13	17	B4345*A0608M000 ²⁾
6 800		91,0 × 144,5	38	35	39	17	14	24	B4345*A0688M000 ²⁾
10 000		91,0 × 191,0	26	26	50	22	18	28	B4345*A0109M000 ²⁾
12 000		91,0 × 221,0	22	22	58	25	21	31	B4345*A0129M000 ²⁾
450		470	51,6 × 80,7	390	420	7,0	3,1	2,6	4,1
	1 000	51,6 × 80,7	180	200	12	5,1	4,2	8,6	B4345*B5108M000
	1 500	64,3 × 105,7	120	130	16	6,9	5,8	9,4	B4345*A5158M000 ²⁾
	2 200	64,3 × 105,7	81	70	18	7,9	6,6	12	B4345*B5228M000 ²⁾
	3 300	76,9 × 143,2	54	48	25	11	9,1	14	B4345*A5338M000 ²⁾
	4 700	76,9 × 220,7	42	39	31	14	11	15	B4345*A5478M000 ²⁾
	4 700	91,0 × 144,5	42	39	31	14	11	19	B4345*J5478M000 ²⁾
	6 000	76,9 × 220,7	33	31	38	17	14	19	B4345*A5608M000 ²⁾
	8 200	91,0 × 221,0	24	24	48	21	18	25	B4345*A5828M000 ²⁾

1) * "5" = for capacitors with ring clip/clamp mounting
"7" = for capacitors with threaded stud

2) For 2-pad solution (types without threaded stud) and for low-inductance design, see page 120.

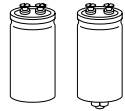

Useful life

depending on ambient temperature T_A (for natural cooling) and versus temperature of case base T_B (for base cooling) under ripple current operating conditions¹⁾

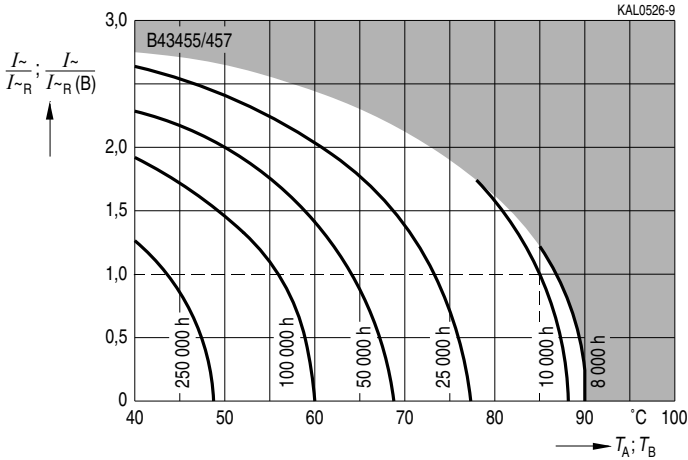

Frequency factor of permissible ripple current I_{\sim} versus frequency f

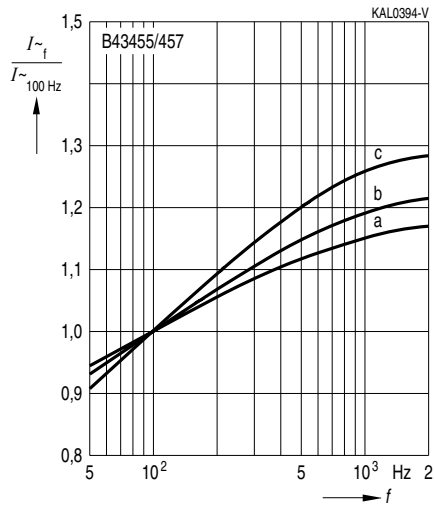

d (mm)	51,6	64,3	76,9	91,0
Curve	c	b	a	c

1) The ripple current refers to $I_{\sim R}$ for natural cooling or to $I_{\sim R(B)}$ for base cooling, respectively. Refer to page 40 for an explanation on how to interpret the useful life graphs.

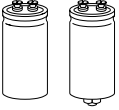

B43455 / B43457

Standard – 85 °C

Frequency characteristics of ESR

Typical behavior

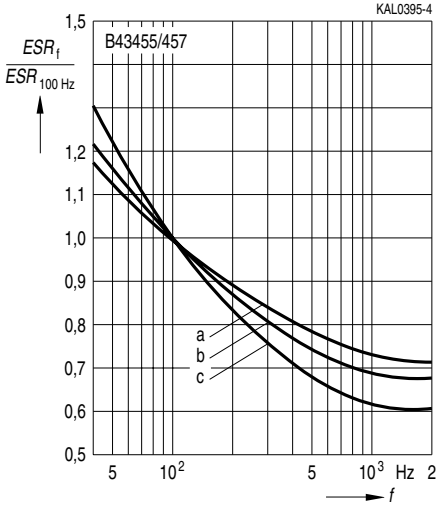

<i>d</i> (mm)	51,6	64,3	76,9	91,0
Curve	c	b	a	a

Impedance Z

versus frequency *f*

Typical behavior at 20 °C

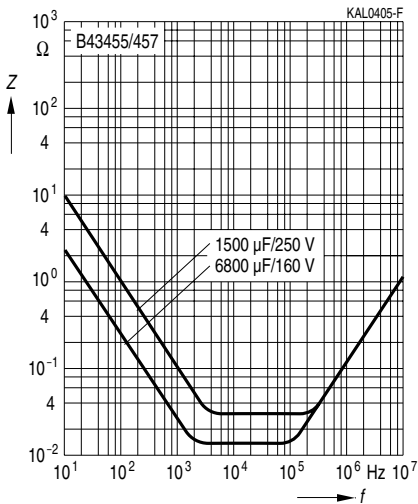

Herausgegeben von EPCOS AG

Unternehmenskommunikation, Postfach 80 17 09, 81617 München, DEUTSCHLAND

☎ ++49 89 636 09, FAX (0 89) 636-2 26 89

© EPCOS AG 2002. Vervielfältigung, Veröffentlichung, Verbreitung und Verwertung dieser Broschüre und ihres Inhalts ohne ausdrückliche Genehmigung der EPCOS AG nicht gestattet.

Bestellungen unterliegen den vom ZVEI empfohlenen Allgemeinen Lieferbedingungen für Erzeugnisse und Leistungen der Elektroindustrie, soweit nichts anderes vereinbart wird.

Diese Broschüre ersetzt die vorige Ausgabe.

Fragen über Technik, Preise und Liefermöglichkeiten richten Sie bitte an den Ihnen nächstgelegenen Vertrieb der EPCOS AG oder an unsere Vertriebsgesellschaften im Ausland. Bauelemente können aufgrund technischer Erfordernisse Gefahrstoffe enthalten. Auskünfte darüber bitten wir unter Angabe des betreffenden Typs ebenfalls über die zuständige Vertriebsgesellschaft einzuholen.

Published by EPCOS AG

Corporate Communications, P.O. Box 80 17 09, 81617 Munich, GERMANY

☎ ++49 89 636 09, FAX (0 89) 636-2 26 89

© EPCOS AG 2002. Reproduction, publication and dissemination of this brochure and the information contained therein without EPCOS' prior express consent is prohibited.

Purchase orders are subject to the General Conditions for the Supply of Products and Services of the Electrical and Electronics Industry recommended by the ZVEI (German Electrical and Electronic Manufacturers' Association), unless otherwise agreed.

This brochure replaces the previous edition.

For questions on technology, prices and delivery please contact the Sales Offices of EPCOS AG or the international Representatives.

Due to technical requirements components may contain dangerous substances. For information on the type in question please also contact one of our Sales Offices.