

# SA58671

## 1.2 W/channel stereo class-D audio amplifier

Rev. 01 — 21 December 2007

Product data sheet

## 1. General description

---

The SA58671 is a stereo, filter-free class-D audio amplifier which is available in a 16 bump WLCSP (Wafer Level Chip-Size Package).

The SA58671 features independent shutdown controls for each channel. The gain can be set at 6 dB, 12 dB, 18 dB or 24 dB using G0 and G1 gain select pins. Improved immunity to noise and RF rectification is increased by high PSRR and differential circuit topology. Fast start-up time and very small WLCSP package makes it an ideal choice for both cellular handsets and PDAs.

The SA58671 delivers 1.3 W/channel at 5 V and 720 mW/channel at 3.6 V into 8  $\Omega$ . It delivers 1.2 W/channel at 5 V into 4  $\Omega$ . The maximum power efficiency is excellent at 70 % to 74 % into 4  $\Omega$  and 84 % to 88 % into 8  $\Omega$ . The SA58671 provides thermal and short-circuit shutdown protection.

## 2. Features

---

- Output power:
  - ◆ 1.2 W/channel into 4  $\Omega$  at 5 V
  - ◆ 1.3 W/channel into 8  $\Omega$  at 5 V
  - ◆ 720 mW/channel into 8  $\Omega$  at 3.6 V
- Supply voltage: 2.5 V to 5.5 V
- Independent shutdown control for each channel
- Selectable gain: 6 dB, 12 dB, 18 dB and 24 dB
- High SVRR: -77 dB at 217 Hz
- Fast start-up time: 3.5 ms
- Low supply current
- Low shutdown current
- Short-circuit and thermal protection
- Space savings with 2.06 mm  $\times$  2.11 mm 16 bump WLCSP package
- Low junction to ambient thermal resistance of 110 K/W with adequate heat sinking of WLCSP

## 3. Applications

---

- Wireless and cellular handsets and PDA
- Portable DVD player
- USB speaker
- Notebook PC

- Portable radio and gaming
- Educational toy

## 4. Ordering information

Table 1. Ordering information

| Type number | Package |  | Version   |
|-------------|---------|--|-----------|
|             | Name    | Description  |           |
| SA58671UK   | WLCSP16 | wafer level chip-size package; 16 bumps;<br>2.06 × 2.11 × 0.6 mm | SA58671UK |

## 5. Block diagram

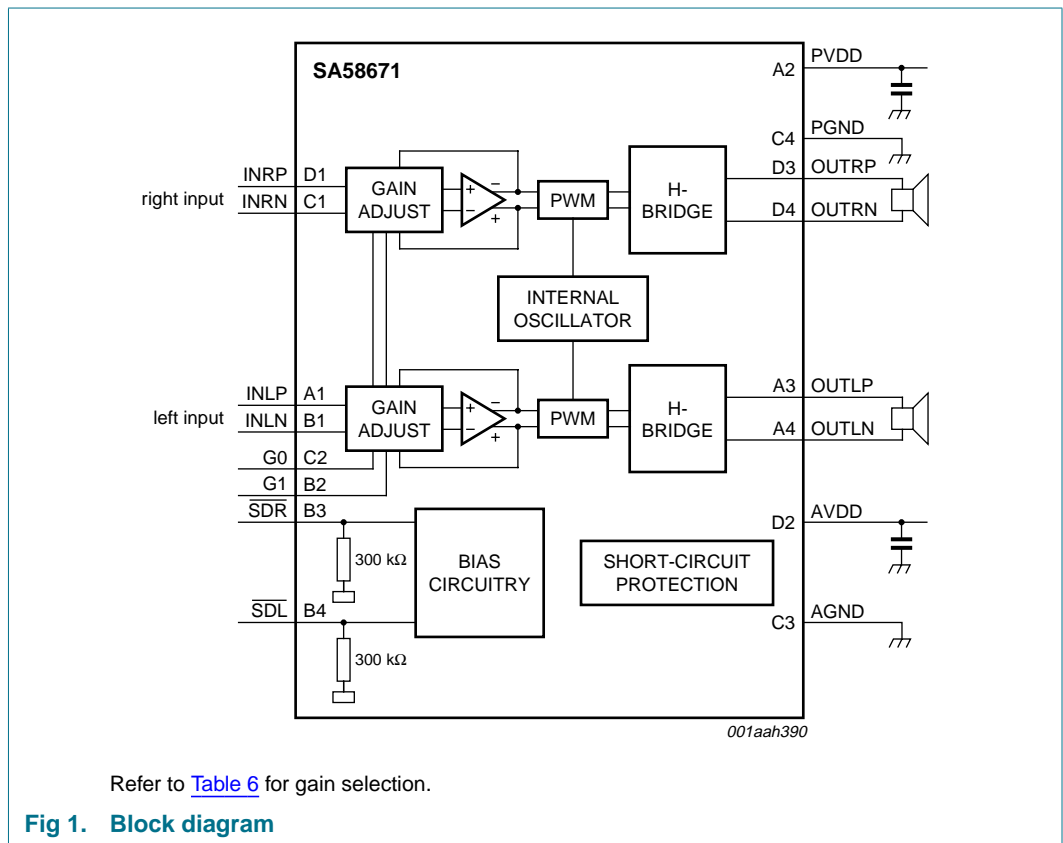

## 6. Pinning information

### 6.1 Pinning

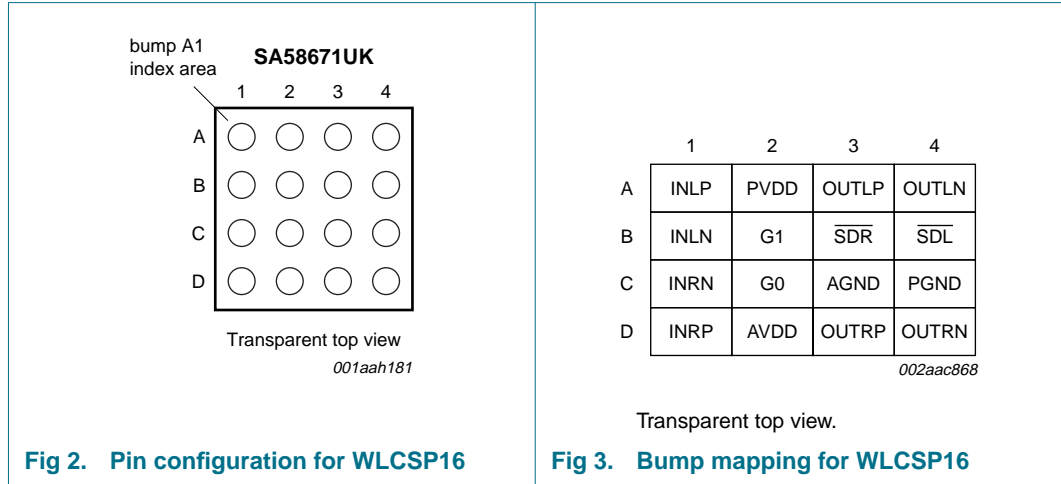

### 6.2 Pin description

Table 2. Pin description

| Symbol | Pin | Description                                |
|--------|-----|--|
| INLP   | A1  | left channel positive input                |
| INLN   | B1  | left channel negative input                |
| INRN   | C1  | right channel negative input               |
| INRP   | D1  | right channel positive input               |
| PVDD   | A2  | power supply voltage (level same as AVDD)  |
| G1     | B2  | gain select input 1                        |
| G0     | C2  | gain select input 0                        |
| AVDD   | D2  | analog supply voltage (level same as PVDD) |
| OUTLP  | A3  | left channel positive output               |
| SDR    | B3  | right channel shutdown input (active LOW)  |
| AGND   | C3  | analog ground                              |
| OUTRP  | D3  | right channel positive output              |
| OUTLN  | A4  | left channel negative output               |
| SDL    | B4  | left channel shutdown input (active LOW)   |
| PGND   | C4  | power ground                               |
| OUTRN  | D4  | right channel negative output              |

## 7. Limiting values

**Table 3. Limiting values**

*In accordance with the Absolute Maximum Rating System (IEC 60134).*

| Symbol           | Parameter            | Conditions                   | Min      | Max                   | Unit |
|------------------|----------------------|------------------------------|----------|-----------------------|------|
| V <sub>DD</sub>  | supply voltage       | active mode                  | [1] -0.3 | +6.0                  | V    |
|                  |                      | shutdown mode                | -0.3     | +7.0                  | V    |
| V <sub>I</sub>   | input voltage        |                              | -0.3     | V <sub>DD</sub> + 0.3 | V    |
| P                | power dissipation    | derating factor<br>9.12 mW/K |          |                       |      |
|                  |                      | T <sub>amb</sub> = 25 °C     | -        | 1.2                   | W    |
|                  |                      | T <sub>amb</sub> = 75 °C     | -        | 690                   | mW   |
|                  |                      | T <sub>amb</sub> = 85 °C     | -        | 600                   | mW   |
| T <sub>amb</sub> | ambient temperature  | operating in free air        | -40      | +85                   | °C   |
| T <sub>j</sub>   | junction temperature | operating                    | -40      | +150                  | °C   |
| T <sub>stg</sub> | storage temperature  |                              | -65      | +85                   | °C   |

[1] V<sub>DD</sub> is the supply voltage on pin PVDD and pin AVDD.

## 8. Static characteristics

**Table 4. Static characteristics**

$T_{amb} = 25\text{ }^{\circ}\text{C}$ ; unless otherwise specified.

| Symbol                   | Parameter                        | Conditions  | Min  | Typ | Max            | Unit             |
|--------------------------|----------------------------------|---|------|-----|----------------|------------------|
| $V_{DD}$                 | supply voltage                   | operating   | 2.5  | -   | 5.5            | V                |
| $ V_{O(\text{offset})} $ | output offset voltage            | measured differentially;<br>inputs AC grounded;<br>$G_{V(\text{cl})} = 6\text{ dB}$ ;<br>$V_{DD} = 2.5\text{ V to } 5.5\text{ V}$ | -    | 5   | 25             | mV               |
| PSRR                     | power supply rejection ratio     | $V_{DD} = 2.5\text{ V to } 5.5\text{ V}$  | -    | -75 | -55            | dB               |
| $V_{i(\text{cm})}$       | common-mode input voltage        |   | 0.5  | -   | $V_{DD} - 0.8$ | V                |
| CMRR                     | common mode rejection ratio      | inputs are shorted together;<br>$V_{DD} = 2.5\text{ V to } 5.5\text{ V}$  | -    | -69 | -50            | dB               |
| $V_{IH}$                 | HIGH-level input voltage         | $V_{DD} = 2.5\text{ V to } 5.5\text{ V}$ ;<br>pins $\overline{\text{SDL}}$ , $\overline{\text{SDR}}$ , $G_0$ , $G_1$              | 1.3  | -   | $V_{DD}$       | V                |
| $V_{IL}$                 | LOW-level input voltage          | $V_{DD} = 2.5\text{ V to } 5.5\text{ V}$ ;<br>pins $\overline{\text{SDL}}$ , $\overline{\text{SDR}}$ , $G_0$ , $G_1$              | 0    | -   | 0.35           | V                |
| $I_{IH}$                 | HIGH-level input current         | $V_{DD} = 5.5\text{ V}$ ; $V_I = V_{DD}$  | -    | -   | 50             | $\mu\text{A}$    |
| $I_{IL}$                 | LOW-level input current          | $V_{DD} = 5.5\text{ V}$ ; $V_I = 0\text{ V}$  | -    | -   | 5              | $\mu\text{A}$    |
| $I_{DD}$                 | supply current                   | $V_{DD} = 5.5\text{ V}$ ; no load   | -    | 6   | 9              | mA               |
|                          |                                  | $V_{DD} = 3.6\text{ V}$ ; no load   | -    | 5   | 7.5            | mA               |
|                          |                                  | $V_{DD} = 2.5\text{ V}$ ; no load   | -    | 4   | 6              | mA               |
| $R_{DSon}$               | drain-source on-state resistance | $V_{DD} = 5.5\text{ V}$   | -    | 500 | -              | $\text{m}\Omega$ |
|                          |                                  | $V_{DD} = 3.6\text{ V}$   | -    | 570 | -              | $\text{m}\Omega$ |
|                          |                                  | $V_{DD} = 2.5\text{ V}$   | -    | 700 | -              | $\text{m}\Omega$ |
| $Z_{o(\text{sd})}$       | shutdown mode output impedance   | $V_{SDR} = V_{SDL} = 0.35\text{ V}$   | -    | 2   | -              | $\text{k}\Omega$ |
| $f_{sw}$                 | switching frequency              | $V_{DD} = 2.5\text{ V to } 5.5\text{ V}$  | 250  | 300 | 350            | kHz              |
| $G_{V(\text{cl})}$       | closed-loop voltage gain         | $V_{G0} = V_{G1} = 0.35\text{ V}$   | 5.5  | 6   | 6.5            | dB               |
|                          |                                  | $V_{G0} = V_{DD}$ ; $V_{G1} = 0.35\text{ V}$  | 11.5 | 12  | 12.5           | dB               |
|                          |                                  | $V_{G0} = 0.35\text{ V}$ ; $V_{G1} = V_{DD}$  | 17.5 | 18  | 18.5           | dB               |
|                          |                                  | $V_{G0} = V_{G1} = V_{DD}$  | 23.5 | 24  | 24.5           | dB               |

## 9. Dynamic characteristics

**Table 5. Dynamic characteristics**

$T_{amb} = 25\text{ }^{\circ}\text{C}$ ;  $R_L = 8\ \Omega$ ; unless otherwise specified.

| Symbol              | Parameter                            | Conditions   | Min | Typ  | Max | Unit          |
|---------------------|--------------------------------------|--|-----|------|-----|---------------|
| $P_o$               | output power                         | per channel; $f = 1\text{ kHz}$ ; THD+N = 10 %   |     |      |     |               |
|                     |                                      | $R_L = 8\ \Omega$ ; $V_{DD} = 5.0\text{ V}$  | -   | 1.3  | -   | W             |
|                     |                                      | $R_L = 8\ \Omega$ ; $V_{DD} = 3.6\text{ V}$  | -   | 0.72 | -   | W             |
|                     |                                      | $R_L = 4\ \Omega$ ; $V_{DD} = 5.0\text{ V}$  | -   | 1.2  | -   | W             |
| THD+N               | total harmonic distortion-plus-noise | $V_{DD} = 5.0\text{ V}$ ; $G_{V(cl)} = 6\text{ dB}$ ; $f = 1\text{ kHz}$                 |     |      |     |               |
|                     |                                      | $P_o = 1\text{ W}$   | -   | 0.14 | -   | %             |
|                     |                                      | $P_o = 0.5\text{ W}$   | -   | 0.11 | -   | %             |
| SVRR                | supply voltage ripple rejection      | $G_{V(cl)} = 6\text{ dB}$ ; $f = 217\text{ Hz}$  |     |      |     |               |
|                     |                                      | $V_{DD} = 5.0\text{ V}$  | -   | -77  | -   | dB            |
|                     |                                      | $V_{DD} = 3.6\text{ V}$  | -   | -73  | -   | dB            |
| CMRR                | common mode rejection ratio          | $V_{DD} = 5.0\text{ V}$ ; $G_{V(cl)} = 6\text{ dB}$ ; $f = 217\text{ Hz}$                | -   | -69  | -   | dB            |
| $Z_i$               | input impedance                      | $G_{V(cl)} = 6\text{ dB}$  | -   | 28.1 | -   | k $\Omega$    |
|                     |                                      | $G_{V(cl)} = 12\text{ dB}$   | -   | 17.3 | -   | k $\Omega$    |
|                     |                                      | $G_{V(cl)} = 18\text{ dB}$   | -   | 9.8  | -   | k $\Omega$    |
|                     |                                      | $G_{V(cl)} = 24\text{ dB}$   | -   | 5.2  | -   | k $\Omega$    |
| $t_{d(sd-startup)}$ | delay time from shutdown to start-up | $V_{DD} = 3.6\text{ V}$  | -   | 3.5  | -   | ms            |
| $V_{n(o)}$          | output noise voltage                 | $V_{DD} = 3.6\text{ V}$ ; $f = 20\text{ Hz}$ to $20\text{ kHz}$ ; inputs are AC grounded |     |      |     |               |
|                     |                                      | no weighting   | -   | 35   | -   | $\mu\text{V}$ |
|                     |                                      | A weighting  | -   | 27   | -   | $\mu\text{V}$ |

10. Typical performance curves

www.DataSheet4U.com

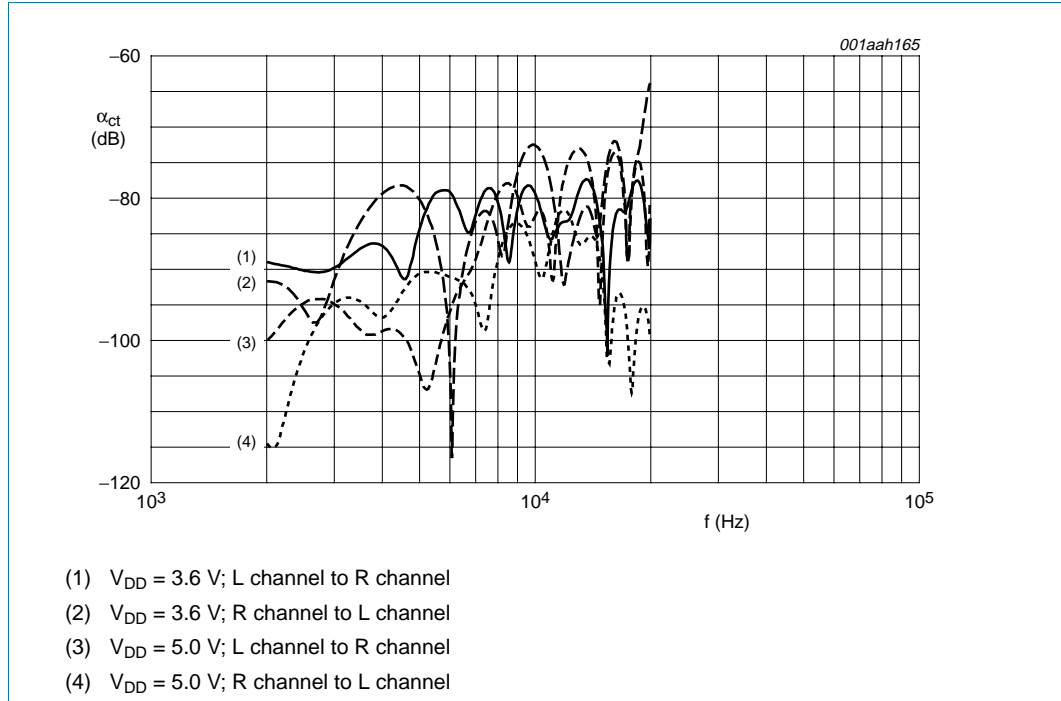

Fig 4. Crosstalk (stepped all-to-one) as a function of frequency

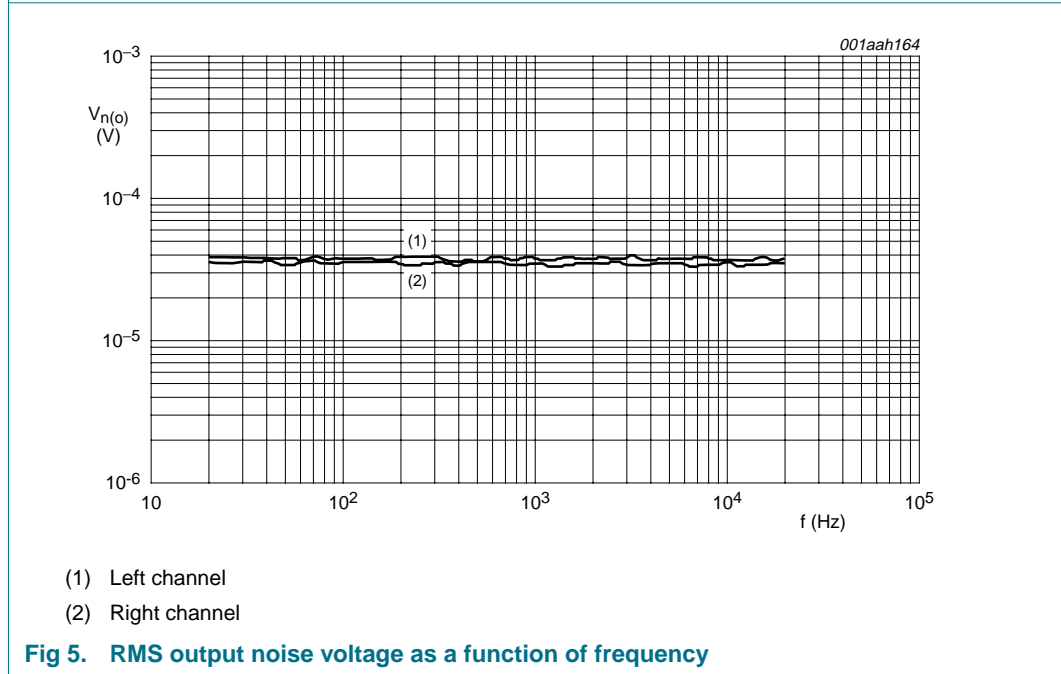
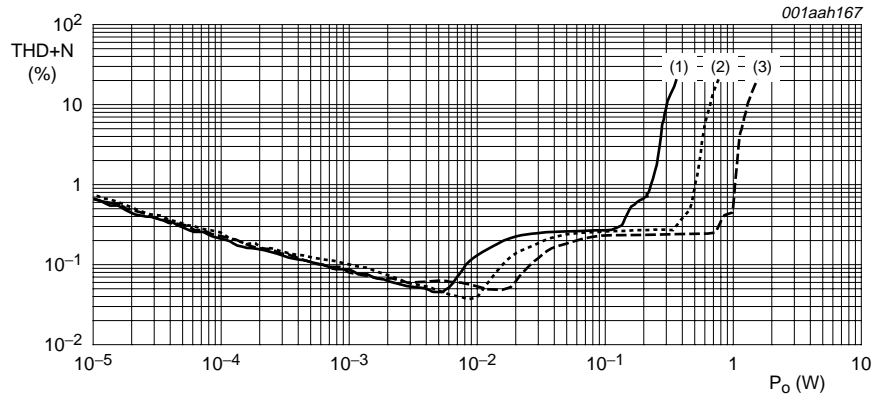
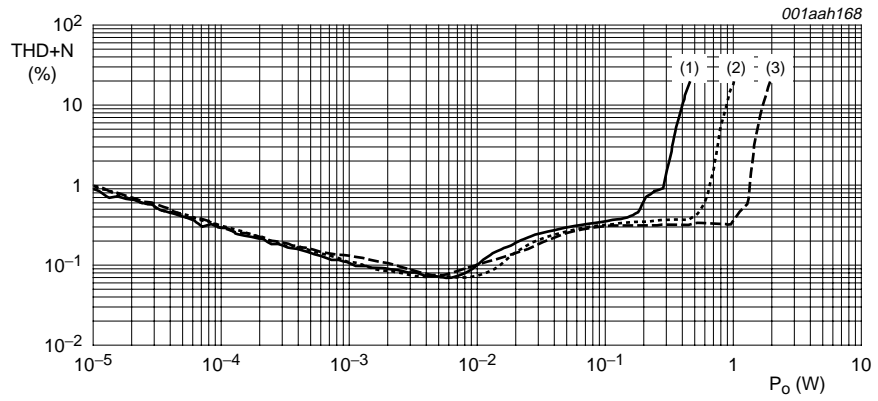

Fig 5. RMS output noise voltage as a function of frequency



a.  $R_L = 8 \Omega$



b.  $R_L = 4 \Omega$

- (1)  $V_{DD} = 2.5 \text{ V}$
- (2)  $V_{DD} = 3.6 \text{ V}$
- (3)  $V_{DD} = 5.0 \text{ V}$

Fig 6. Total harmonic distortion-plus-noise as a function of output power;  $G_{V(cl)} = 6 \text{ dB}$



www.DataSheet4U.com

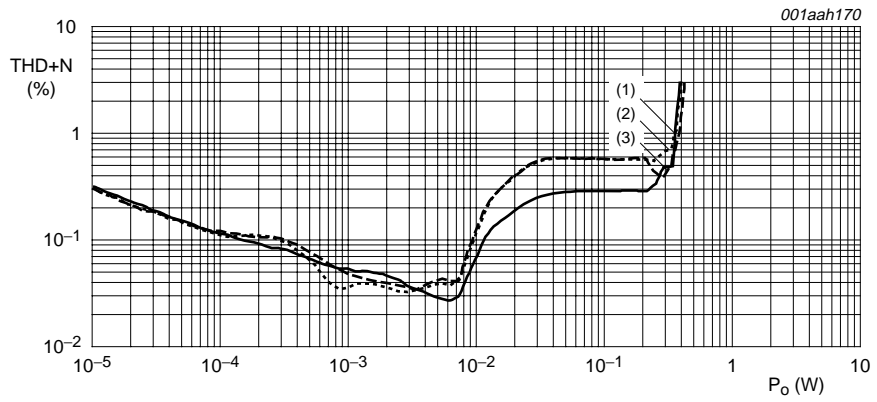

a.  $V_{DD} = 3.0\text{ V}$

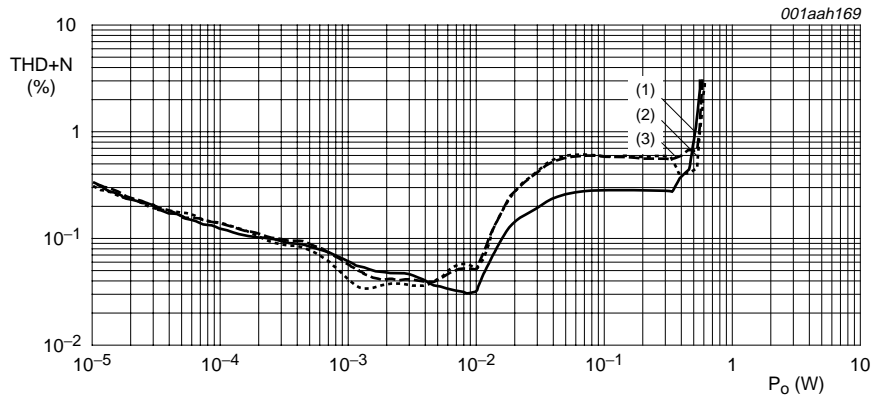

b.  $V_{DD} = 3.6\text{ V}$

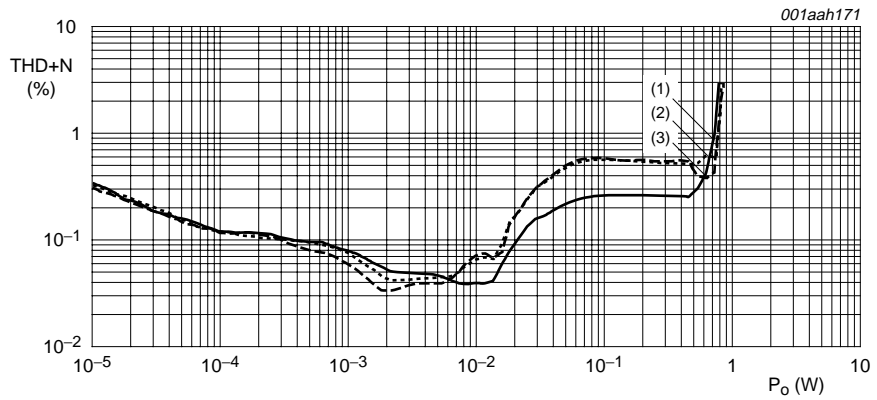

c.  $V_{DD} = 4.2\text{ V}$

- (1)  $f_i = 1\text{ kHz}$
- (2)  $f_i = 3\text{ kHz}$
- (3)  $f_i = 5\text{ kHz}$

**Fig 7. Total harmonic distortion-plus-noise as a function of output power;  $R_L = 8\ \Omega$ ;  $G_{V(cl)} = 6\text{ dB}$**

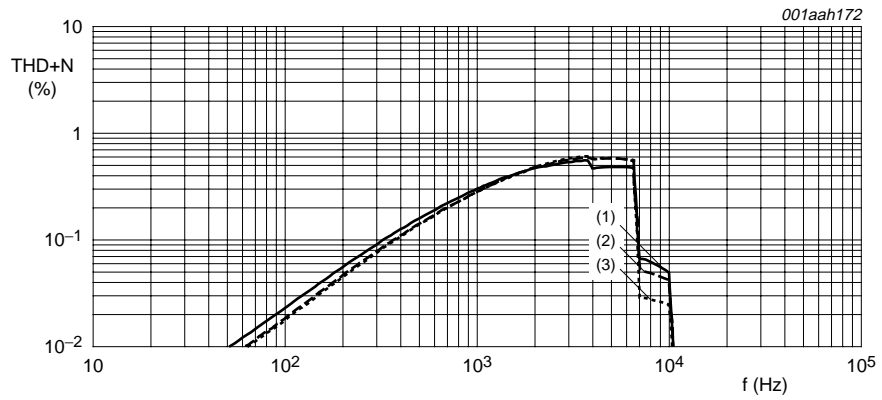

a.  $R_L = 8 \Omega$

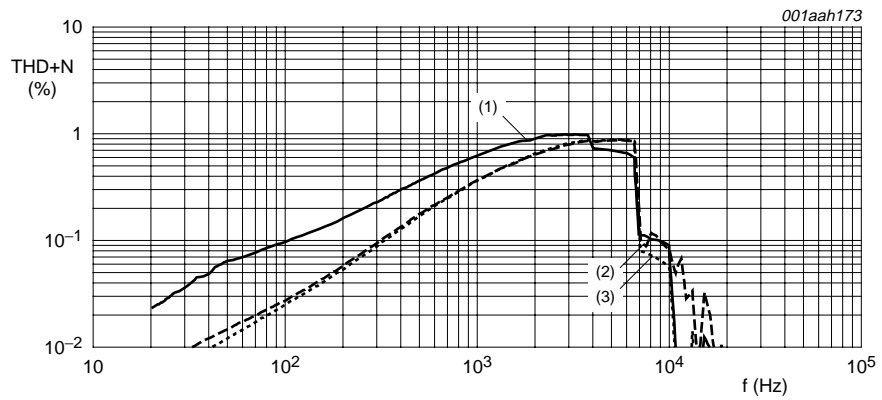

b.  $R_L = 4 \Omega$

- (1)  $V_I = 900 \text{ mV}$
- (2)  $V_I = 725 \text{ mV}$
- (3)  $V_I = 525 \text{ mV}$

**Fig 8. Total harmonic distortion-plus-noise as a function of frequency;  $V_{DD} = 3.6 \text{ V}$**

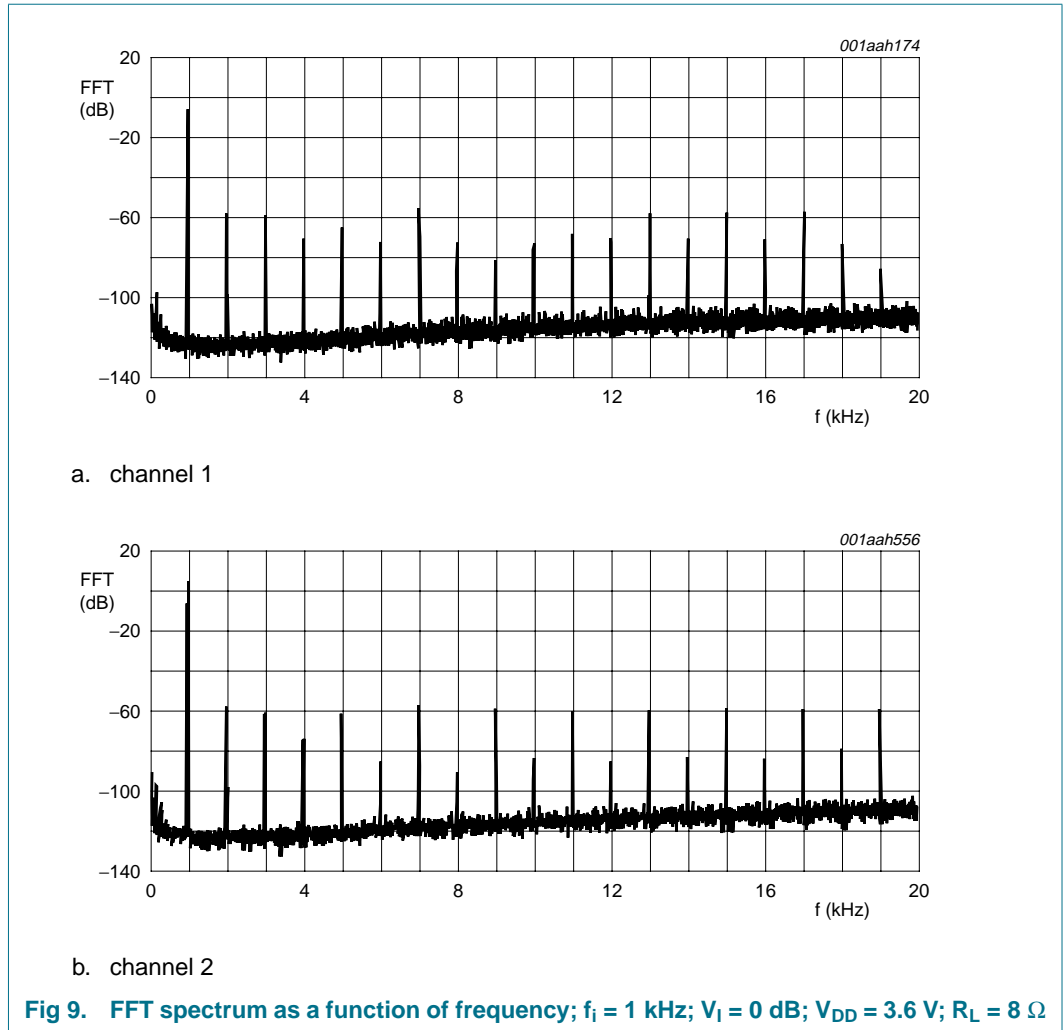

www.DataSheet4U.com

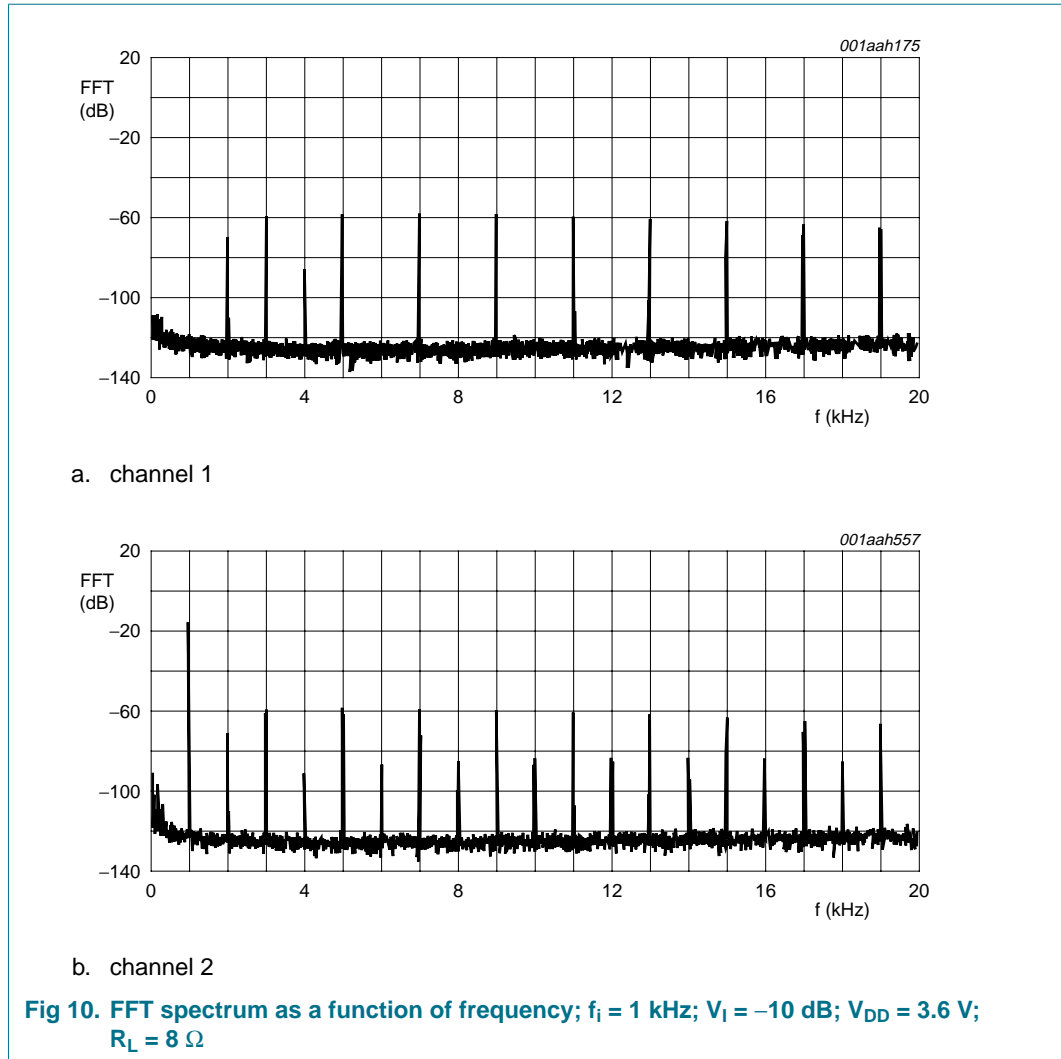

www.DataSheet4U.com

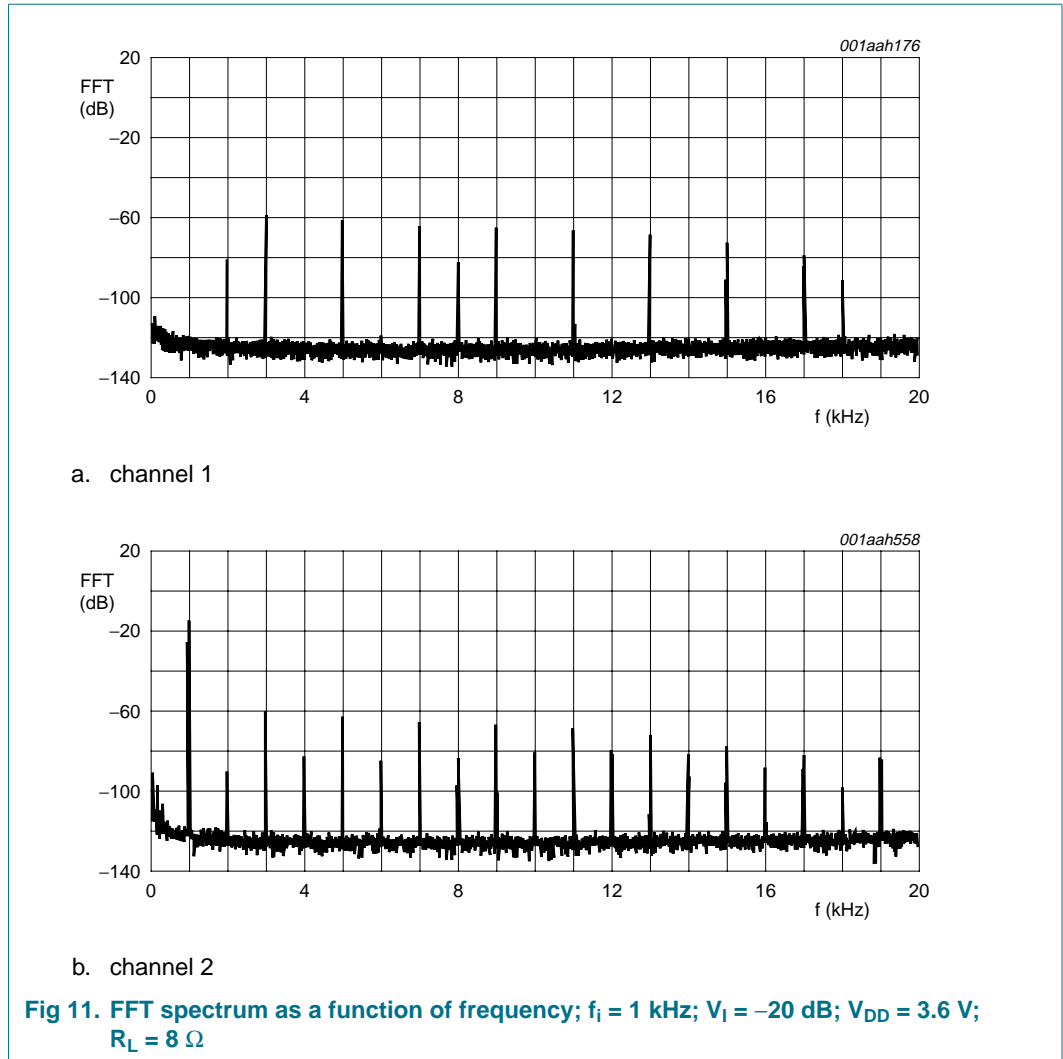

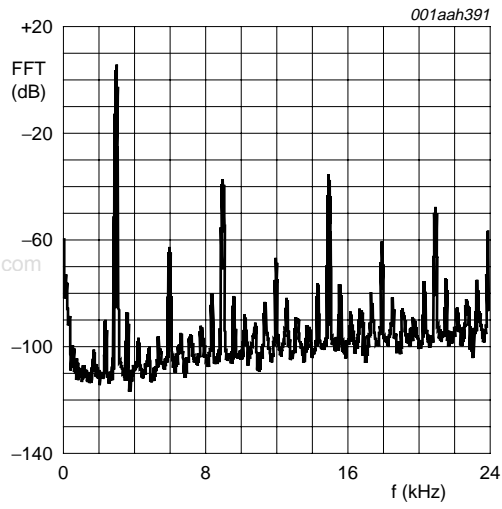

a.  $V_1 = 0$  dB

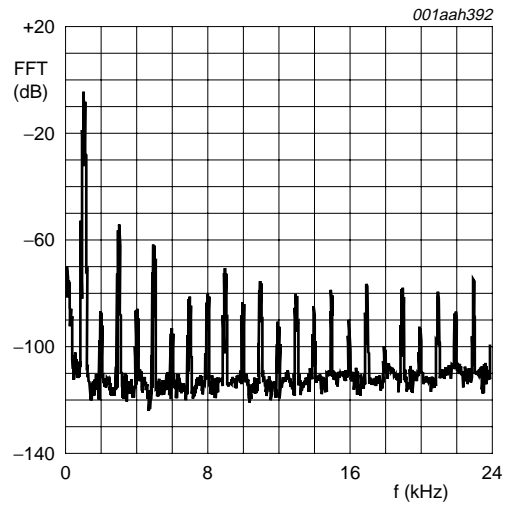

b.  $V_1 = -10$  dB

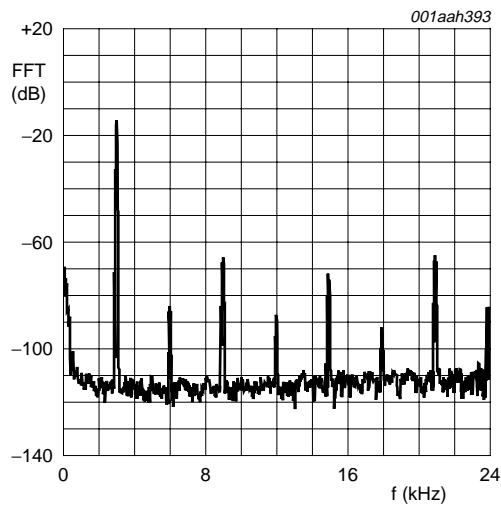

c.  $V_1 = -20$  dB

Fig 12. FFT spectrum as a function of frequency;  $f_i = 3$  kHz;  $V_{DD} = 3.6$  V;  $R_L = 8 \Omega$

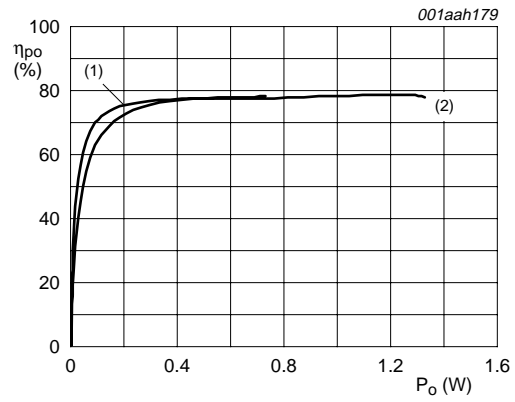
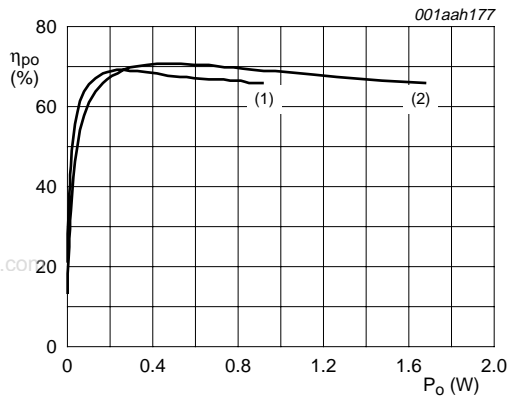

- a.  $R_L = 4 \Omega$   
 (1)  $V_{DD} = 3.6 V$   
 (2)  $V_{DD} = 5.0 V$

- b.  $R_L = 8 \Omega$

Fig 13. Output power efficiency as a function of output power

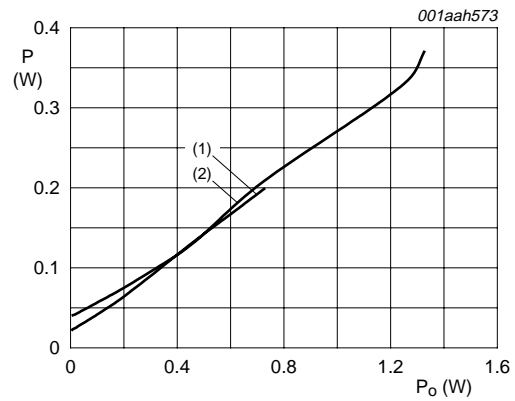
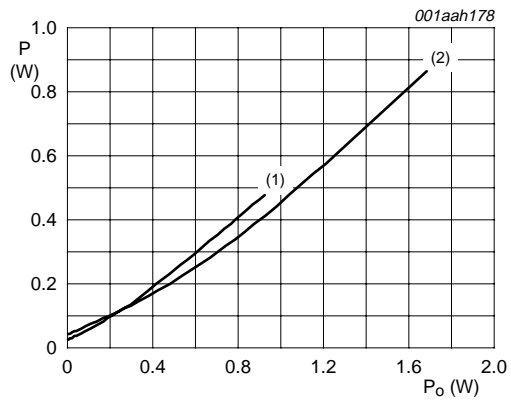

- a.  $R_L = 4 \Omega$   
 (1)  $V_{DD} = 3.6 V$   
 (2)  $V_{DD} = 5.0 V$

- b.  $R_L = 8 \Omega$

Fig 14. Power dissipation as a function of output power

## 11. Application information

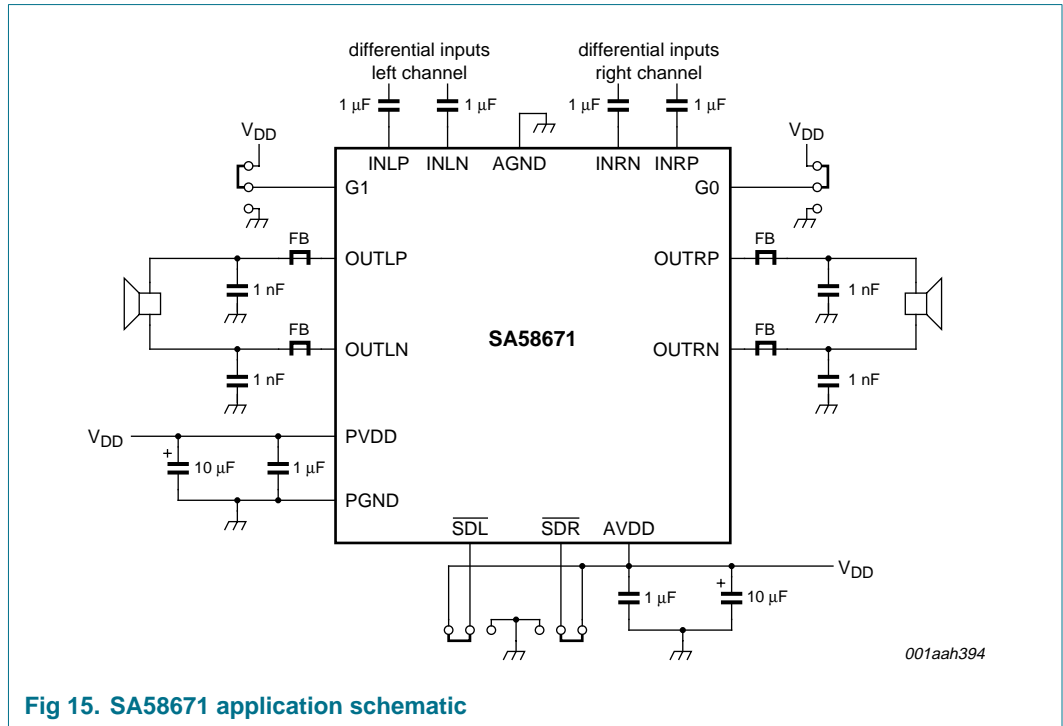

Fig 15. SA58671 application schematic

### 11.1 Power supply decoupling considerations

The SA58671 is a stereo class-D audio amplifier that requires proper power supply decoupling to ensure the rated performance for THD+N and power efficiency. To decouple high frequency transients, power supply spikes and digital noise on the power bus line, a low Equivalent Series Resistance (ESR) capacitor of typically 1 μF is placed as close as possible to the PVDD pins of the device. It is important to place the decoupling capacitor at the power pins of the device because any resistance or inductance in the PCB trace between the device and the capacitor can cause a loss in efficiency. Additional decoupling using a larger capacitor, 4.7 μF or greater, may be done on the power supply connection on the PCB to filter low frequency signals. Usually this is not required due to high PSRR of the device.

### 11.2 Input capacitor selection

The SA58671 does not require input coupling capacitors when used with a differential audio source that is biased from 0.5 V to V<sub>DD</sub> - 0.8 V. In other words, the input signal must be biased within the common-mode input voltage range. If high pass filtering is required or if it is driven using a single-ended source, input coupling capacitors are required.

The 3 dB cut-off frequency created by the input coupling capacitor and the input resistors (see Table 6) is calculated by Equation 1:

$$f_{-3dB} = \frac{1}{2\pi \times R_i \times C_i} \tag{1}$$



**Table 6. Gain selection**

| G1   | G0   | Gain (V/V) | Gain (dB) | Input impedance (kΩ) |
|------|------|------------|-----------|----------------------|
| LOW  | LOW  | 2          | 6         | 28.1                 |
| LOW  | HIGH | 4          | 12        | 17.3                 |
| HIGH | LOW  | 8          | 18        | 9.8                  |
| HIGH | HIGH | 16         | 24        | 5.2                  |

Since the value of the input decoupling capacitor and the input resistance determined by the gain setting affects the low frequency performance of the audio amplifier, it is important to consider this during the system design. Small speakers in wireless and cellular phones usually do not respond well to low frequency signals, so the 3 dB cut-off frequency may be increased to block the low frequency signals to the speakers. Not using input coupling capacitors may increase the output offset voltage.

Equation 1 is solved for  $C_i$ :

$$C_i = \frac{I}{2\pi \times R_i \times f_{-3dB}} \tag{2}$$

### 11.3 PCB layout considerations

Component location is very important for performance of the SA58671. Place all external components very close to the device. Placing decoupling capacitors directly at the power supply pins increases efficiency because the resistance and inductance in the trace between the device power supply pins and the decoupling capacitor causes a loss in power efficiency.

The trace width and routing are also very important for power output and noise considerations.

For high current terminals (PVDD, PGND and audio output), the trace widths should be maximized to ensure proper performance and output power. Use at least 500 μm wide traces.

For the input pins (INRP, INRN, INLP and INLN), the traces must be symmetrical and run side-by-side to maximize common-mode cancellation.

### 11.4 Filter-free operation and ferrite bead filters

A ferrite bead low-pass filter can be used to reduce radio frequency emissions in applications that have circuits sensitive to frequencies greater than 1 MHz. A ferrite bead low-pass filter functions well for amplifiers that must pass FCC unintentional radiation requirements for frequencies greater than 30 MHz. Choose a bead with high-impedance at high frequencies and very low-impedance at low frequencies. In order to prevent distortion of the output signal, select a ferrite bead with adequate current rating.

For applications in which there are circuits that are EMI sensitive to low frequency (< 1 MHz) and there are long leads from amplifier to speaker, it is necessary to use an LC output filter.

11.5 Efficiency and thermal considerations

The maximum ambient temperature depends on the heat transferring ability of the heat spreader on the PCB layout. In [Table 3 “Limiting values”](#), power dissipation, the power derating factor is given as 9.12 mW/K. The device thermal resistance,  $R_{th(j-a)}$  is the reciprocal of the power derating factor. Convert the power derating factor to  $R_{th(j-a)}$  by [Equation 3](#):

$$R_{th(j-a)} = \frac{1}{\text{derating factor}} = \frac{1}{0.00912} = 110 \text{ K/W} \tag{3}$$

For a maximum allowable junction temperature,  $T_j = 150 \text{ }^\circ\text{C}$  and  $R_{th(j-a)} = 110 \text{ K/W}$  and a maximum device dissipation of 0.6 W (300 mW per channel) and for 1.2 W per channel output power, 4  $\Omega$  load, 5 V supply, the maximum ambient temperature is calculated using [Equation 4](#):

$$T_{amb(max)} = T_{j(max)} - (R_{th(j-a)} \times P_{max}) = 150 - (110 \times 0.60) = 84 \text{ }^\circ\text{C} \tag{4}$$

The maximum ambient temperature is 84  $^\circ\text{C}$  at maximum power dissipation for 5 V supply and 4  $\Omega$  load. If the junction temperature of the SA58671 rises above 150  $^\circ\text{C}$ , the thermal protection circuitry turns the device off; this prevents damage to IC. Using speakers greater than 4  $\Omega$  further enhances thermal performance and battery lifetime by reducing the output load current and increasing amplifier efficiency.

11.6 Additional thermal information

The SA58671 16 bump WLCSP package ground bumps are soldered directly to the PCB heat spreader. By the use of thermal vias, the bumps may be soldered directly to a ground plane or special heat sinking layer designed into the PCB. The thickness and area of the heat spreader may be maximized to optimize heat transfer and achieve lowest package thermal resistance.

12. Test information

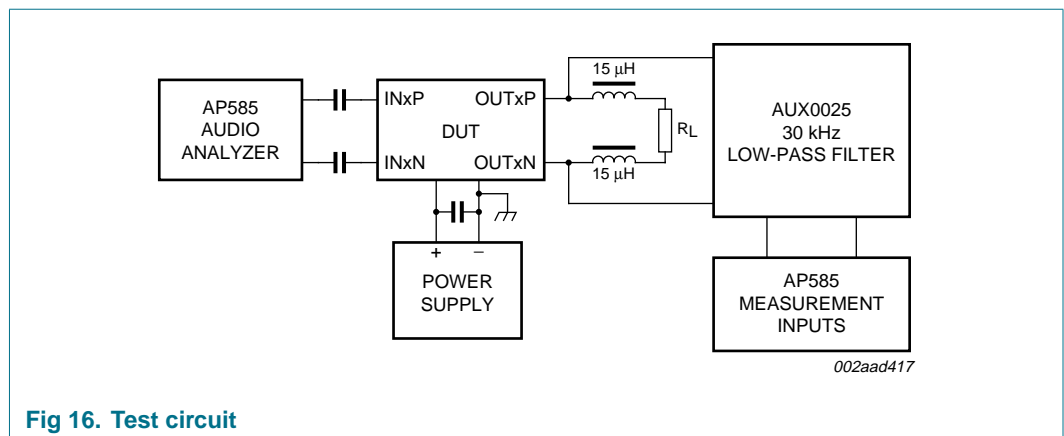

Fig 16. Test circuit

13. Package outline

WLCSP16: wafer level chip-size package; 16 bumps; 2.06 x 2.11 x 0.6 mm

SA58671UK

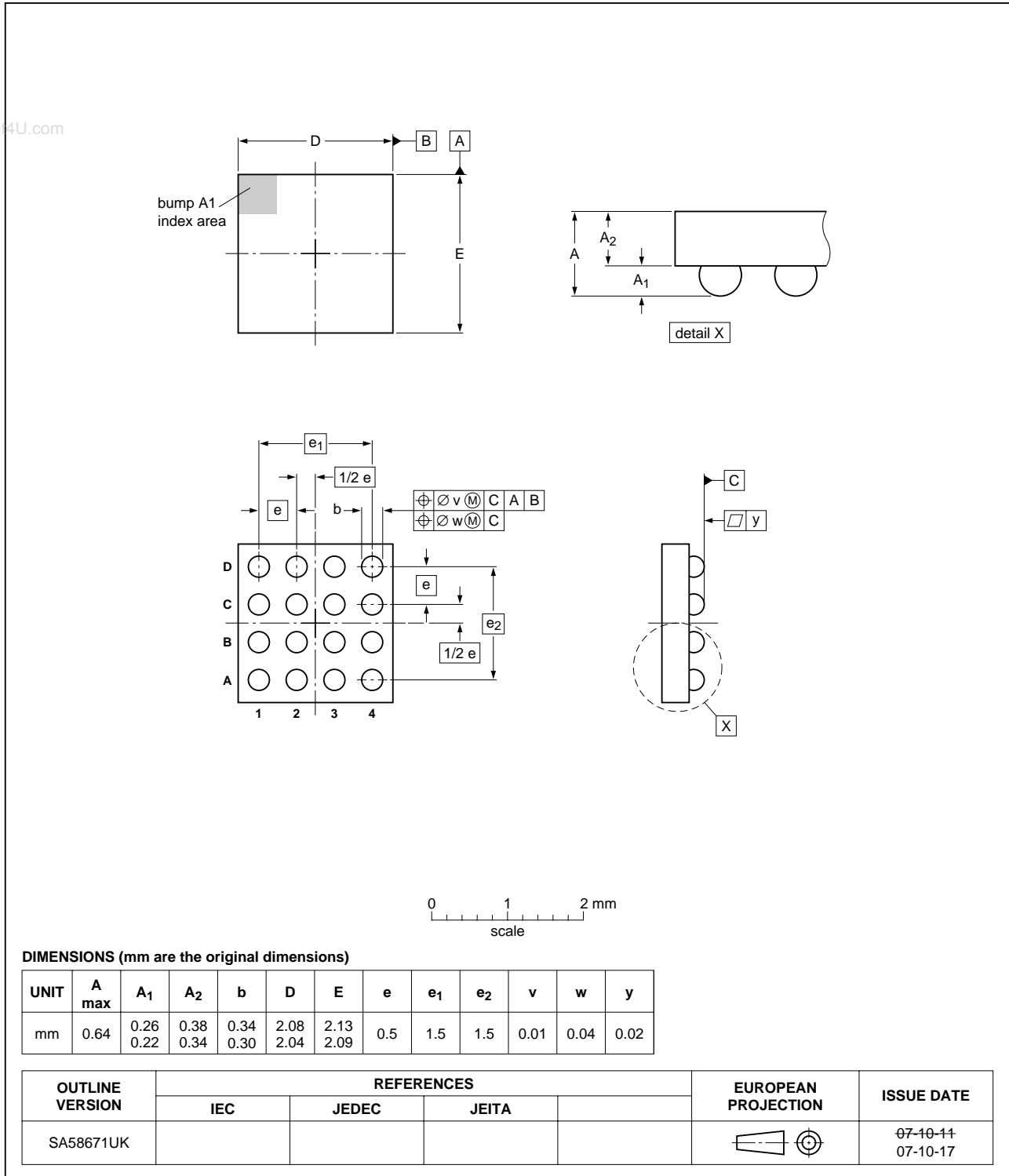

Fig 17. Package outline WLCSP16

## 14. Soldering

This text provides a very brief insight into a complex technology. A more in-depth account of soldering ICs can be found in Application Note *AN10365 "Surface mount reflow soldering description"*.

### 14.1 Introduction to soldering

Soldering is one of the most common methods through which packages are attached to Printed Circuit Boards (PCBs), to form electrical circuits. The soldered joint provides both the mechanical and the electrical connection. There is no single soldering method that is ideal for all IC packages. Wave soldering is often preferred when through-hole and Surface Mount Devices (SMDs) are mixed on one printed wiring board; however, it is not suitable for fine pitch SMDs. Reflow soldering is ideal for the small pitches and high densities that come with increased miniaturization.

### 14.2 Wave and reflow soldering

Wave soldering is a joining technology in which the joints are made by solder coming from a standing wave of liquid solder. The wave soldering process is suitable for the following:

- Through-hole components
- Leaded or leadless SMDs, which are glued to the surface of the printed circuit board

Not all SMDs can be wave soldered. Packages with solder balls, and some leadless packages which have solder lands underneath the body, cannot be wave soldered. Also, leaded SMDs with leads having a pitch smaller than ~0.6 mm cannot be wave soldered, due to an increased probability of bridging.

The reflow soldering process involves applying solder paste to a board, followed by component placement and exposure to a temperature profile. Leaded packages, packages with solder balls, and leadless packages are all reflow solderable.

Key characteristics in both wave and reflow soldering are:

- Board specifications, including the board finish, solder masks and vias
- Package footprints, including solder thieves and orientation
- The moisture sensitivity level of the packages
- Package placement
- Inspection and repair
- Lead-free soldering versus PbSn soldering

### 14.3 Wave soldering

Key characteristics in wave soldering are:

- Process issues, such as application of adhesive and flux, clinching of leads, board transport, the solder wave parameters, and the time during which components are exposed to the wave
- Solder bath specifications, including temperature and impurities

### 14.4 Reflow soldering

Key characteristics in reflow soldering are:

- Lead-free versus SnPb soldering; note that a lead-free reflow process usually leads to higher minimum peak temperatures (see [Figure 18](#)) than a PbSn process, thus reducing the process window
- Solder paste printing issues including smearing, release, and adjusting the process window for a mix of large and small components on one board
- Reflow temperature profile; this profile includes preheat, reflow (in which the board is heated to the peak temperature) and cooling down. It is imperative that the peak temperature is high enough for the solder to make reliable solder joints (a solder paste characteristic). In addition, the peak temperature must be low enough that the packages and/or boards are not damaged. The peak temperature of the package depends on package thickness and volume and is classified in accordance with [Table 7](#) and [8](#)

**Table 7. SnPb eutectic process (from J-STD-020C)**

| Package thickness (mm) | Package reflow temperature (°C) |       |
|------------------------|---------------------------------|-------|
|                        | Volume (mm <sup>3</sup> )       |       |
|                        | < 350                           | ≥ 350 |
| < 2.5                  | 235                             | 220   |
| ≥ 2.5                  | 220                             | 220   |

**Table 8. Lead-free process (from J-STD-020C)**

| Package thickness (mm) | Package reflow temperature (°C) |             |        |
|------------------------|---------------------------------|-------------|--------|
|                        | Volume (mm <sup>3</sup> )       |             |        |
|                        | < 350                           | 350 to 2000 | > 2000 |
| < 1.6                  | 260                             | 260         | 260    |
| 1.6 to 2.5             | 260                             | 250         | 245    |
| > 2.5                  | 250                             | 245         | 245    |

Moisture sensitivity precautions, as indicated on the packing, must be respected at all times.

Studies have shown that small packages reach higher temperatures during reflow soldering, see [Figure 18](#).

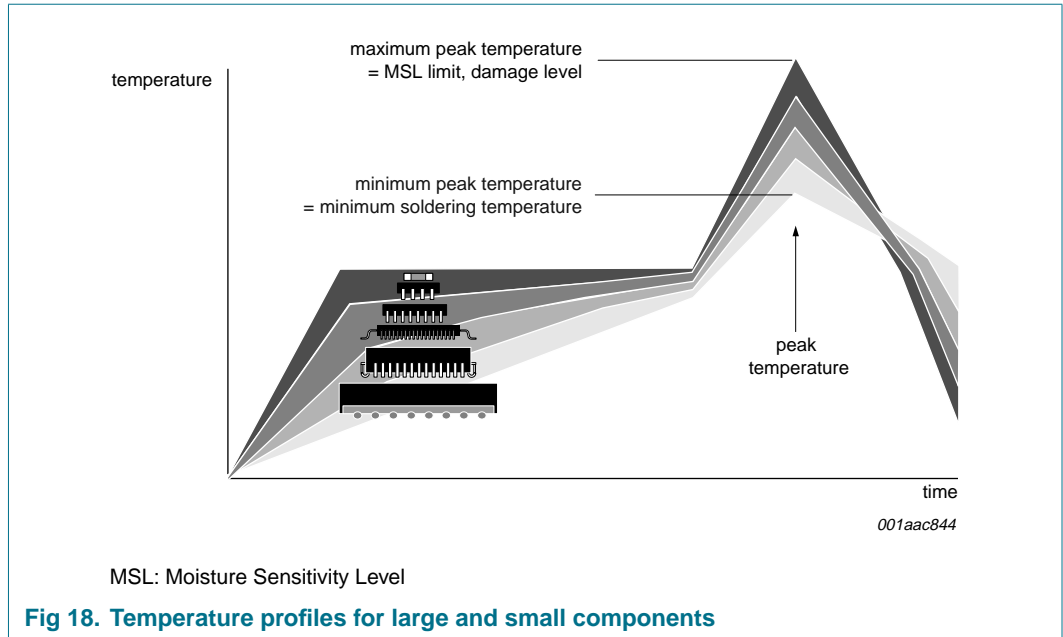

For further information on temperature profiles, refer to Application Note AN10365 “Surface mount reflow soldering description”.

## 15. Abbreviations

**Table 9. Abbreviations**

| Acronym | Description                   |
|---------|-------------------------------|
| DUT     | Device Under Test             |
| DVD     | Digital Video Disc            |
| EMI     | ElectroMagnetic Interference  |
| ESR     | Equivalent Series Resistance  |
| FFT     | Fast Fourier Transform        |
| LC      | inductor-capacitor filter     |
| PC      | Personal Computer             |
| PCB     | Printed-Circuit Board         |
| PDA     | Personal Digital Assistant    |
| PSRR    | Power Supply Rejection Ratio  |
| PWM     | Pulse Width Modulator         |
| USB     | Universal Serial Bus          |
| WLCSP   | Wafer Level Chip-Size Package |

## 16. Revision history

**Table 10. Revision history**

| Document ID | Release date | Data sheet status  | Change notice | Supersedes |
|-------------|--------------|--------------------|---------------|------------|
| SA58671_1   | 20071221     | Product data sheet | -             | -          |

## 17. Legal information

### 17.1 Data sheet status

| Document status <sup>[1][2]</sup> | Product status <sup>[3]</sup> | Definition  |
|-----------------------------------|-------------------------------|---|
| Objective [short] data sheet      | Development                   | This document contains data from the objective specification for product development. |
| Preliminary [short] data sheet    | Qualification                 | This document contains data from the preliminary specification.                       |
| Product [short] data sheet        | Production                    | This document contains the product specification.                                     |

[1] Please consult the most recently issued document before initiating or completing a design.

[2] The term 'short data sheet' is explained in section "Definitions".

[3] The product status of device(s) described in this document may have changed since this document was published and may differ in case of multiple devices. The latest product status information is available on the Internet at URL <http://www.nxp.com>.

### 17.2 Definitions

**Draft** — The document is a draft version only. The content is still under internal review and subject to formal approval, which may result in modifications or additions. NXP Semiconductors does not give any representations or warranties as to the accuracy or completeness of information included herein and shall have no liability for the consequences of use of such information.

**Short data sheet** — A short data sheet is an extract from a full data sheet with the same product type number(s) and title. A short data sheet is intended for quick reference only and should not be relied upon to contain detailed and full information. For detailed and full information see the relevant full data sheet, which is available on request via the local NXP Semiconductors sales office. In case of any inconsistency or conflict with the short data sheet, the full data sheet shall prevail.

### 17.3 Disclaimers

**General** — Information in this document is believed to be accurate and reliable. However, NXP Semiconductors does not give any representations or warranties, expressed or implied, as to the accuracy or completeness of such information and shall have no liability for the consequences of use of such information.

**Right to make changes** — NXP Semiconductors reserves the right to make changes to information published in this document, including without limitation specifications and product descriptions, at any time and without notice. This document supersedes and replaces all information supplied prior to the publication hereof.

**Suitability for use** — NXP Semiconductors products are not designed, authorized or warranted to be suitable for use in medical, military, aircraft, space or life support equipment, nor in applications where failure or

malfunction of an NXP Semiconductors product can reasonably be expected to result in personal injury, death or severe property or environmental damage. NXP Semiconductors accepts no liability for inclusion and/or use of NXP Semiconductors products in such equipment or applications and therefore such inclusion and/or use is at the customer's own risk.

**Applications** — Applications that are described herein for any of these products are for illustrative purposes only. NXP Semiconductors makes no representation or warranty that such applications will be suitable for the specified use without further testing or modification.

**Limiting values** — Stress above one or more limiting values (as defined in the Absolute Maximum Ratings System of IEC 60134) may cause permanent damage to the device. Limiting values are stress ratings only and operation of the device at these or any other conditions above those given in the Characteristics sections of this document is not implied. Exposure to limiting values for extended periods may affect device reliability.

**Terms and conditions of sale** — NXP Semiconductors products are sold subject to the general terms and conditions of commercial sale, as published at <http://www.nxp.com/profile/terms>, including those pertaining to warranty, intellectual property rights infringement and limitation of liability, unless explicitly otherwise agreed to in writing by NXP Semiconductors. In case of any inconsistency or conflict between information in this document and such terms and conditions, the latter will prevail.

**No offer to sell or license** — Nothing in this document may be interpreted or construed as an offer to sell products that is open for acceptance or the grant, conveyance or implication of any license under any copyrights, patents or other industrial or intellectual property rights.

### 17.4 Trademarks

Notice: All referenced brands, product names, service names and trademarks are the property of their respective owners.

## 18. Contact information

For additional information, please visit: <http://www.nxp.com>

For sales office addresses, send an email to: [salesaddresses@nxp.com](mailto:salesaddresses@nxp.com)

19. Contents

1 General description . . . . . 1

2 Features . . . . . 1

3 Applications . . . . . 1

4 Ordering information . . . . . 2

5 Block diagram . . . . . 2

6 Pinning information . . . . . 3

6.1 Pinning . . . . . 3

6.2 Pin description . . . . . 3

7 Limiting values . . . . . 4

8 Static characteristics . . . . . 5

9 Dynamic characteristics . . . . . 6

10 Typical performance curves . . . . . 7

11 Application information . . . . . 16

11.1 Power supply decoupling considerations . . . . . 16

11.2 Input capacitor selection . . . . . 16

11.3 PCB layout considerations . . . . . 17

11.4 Filter-free operation and ferrite bead filters . . . . . 17

11.5 Efficiency and thermal considerations . . . . . 18

11.6 Additional thermal information . . . . . 18

12 Test information . . . . . 18

13 Package outline . . . . . 19

14 Soldering . . . . . 20

14.1 Introduction to soldering . . . . . 20

14.2 Wave and reflow soldering . . . . . 20

14.3 Wave soldering . . . . . 20

14.4 Reflow soldering . . . . . 21

15 Abbreviations . . . . . 22

16 Revision history . . . . . 22

17 Legal information . . . . . 23

17.1 Data sheet status . . . . . 23

17.2 Definitions . . . . . 23

17.3 Disclaimers . . . . . 23

17.4 Trademarks . . . . . 23

18 Contact information . . . . . 23

19 Contents . . . . . 24

www.DataSheet4U.com

Please be aware that important notices concerning this document and the product(s) described herein, have been included in section 'Legal information'.



© NXP B.V. 2007. All rights reserved.  
 For more information, please visit: <http://www.nxp.com>  
 For sales office addresses, please send an email to: [salesaddresses@nxp.com](mailto:salesaddresses@nxp.com)  
 Date of release: 21 December 2007  
 Document identifier: SA58671\_1