

# EVERLIGHT

the source of light

## DATASHEET

## LIFESTYLE LIGHTS

### Crane<sup>fun</sup> Portable LED Lamp Series



### Features

- Multi-functions: Reading light, night light, and clock modes.
- No UV or IR light radiation
- No direct, no reflected glare or flicker of light
- Excellent for reading
- Step dimming function: 100%→80%→60%→40%→20%
- Universal power input
- Current controlled LED driver integrated on PCB
- Operation temperature: -20 °C ~40 °C

### Description

Combining mechanics, form and versatility, the Everlight CRANE-FUN desk lamp will not only brighten your workspace, but also increase efficiency. Use it as a mood light or as a night light, fold it out to create a desk lamp or fold it up to create a representative design element. No matter how you decide to use it, the Everlight CRANE-FUN will attract everyone with its discrete charm

### Applications

- Home Lighting
- Bedroom Lighting
- Reading light
- Night Light
- Clock

## Coding of Part Number:

Crane-Fun / P10 / CW / SD / PW / CH

1 2 3 4 5 6

### 1. Product Series

Crane-Fun: Crane-Fun LED Portable Lamp Series

### 2. Power Consumption

P12: 12 watts (EU/US version)

P10: 10 watts (CH version)

### 3. Correlated Color Temperature

CW: Cold White

### 4. Dimming Control

SD: Step Dimming

### 5. Color

PW : Pearl White

PB : Pearl Black

PM : Pearl Magenta

### 6. Region

EU: Europe Regions

US: North America Regions

CH: Asia Regions

## Product Dimensions

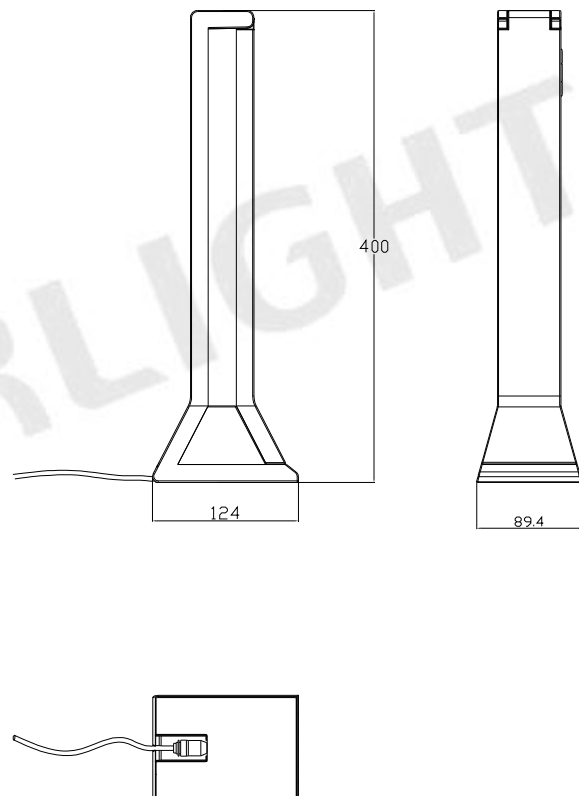

Notes: 1. Dimensions are in millimeters  
2. Tolerances unless otherwise mentioned  $\pm 0.5\text{mm}$

### Luminance and Technical Data

Product Name	Crane-Fun/P12/CW/SD/ P(W.B.M)/EU	Crane-Fun/P12/CW/SD/ P(W.B.M)/US	Crane-Fun/P10/CW/SD/ P(W.B.M)/CH
Product Family	Liifestyle Lights	Liifestyle Lights	Liifestyle Lights
Main Use	Reading Light, Night Light, Mood Light, Clock	Reading Light, Night Light, Mood Light, Clock	Reading Light, Night Light, Mood Light, Clock
Input Voltage/ Frequency	100-240VAC / 50-60Hz	100-240VAC / 50-60Hz	100-240VAC / 50-60Hz
Power Consumption	12 W	12 W	10 W
Dimability	Yes	Yes	Yes
Mechanical Dimensions	124*89.4*400mm	124*89.4*400mm	124*89.4*400mm
Maximum Weight	1500g	1500g	1500g
Light Color	Cold White	Cold White	Cold White
Lux (Typ.)	1000	1000	1000
Operation Temperature	-20 ~40	-20 ~40	-20 ~40
Storage Temperature	-30 ~80	-30 ~80	-30 ~80
Certification	CE, CB, GS	UL, FCC	BSMI

Luminous Flux measurement tolerance  $\pm 10\%$

### Package information

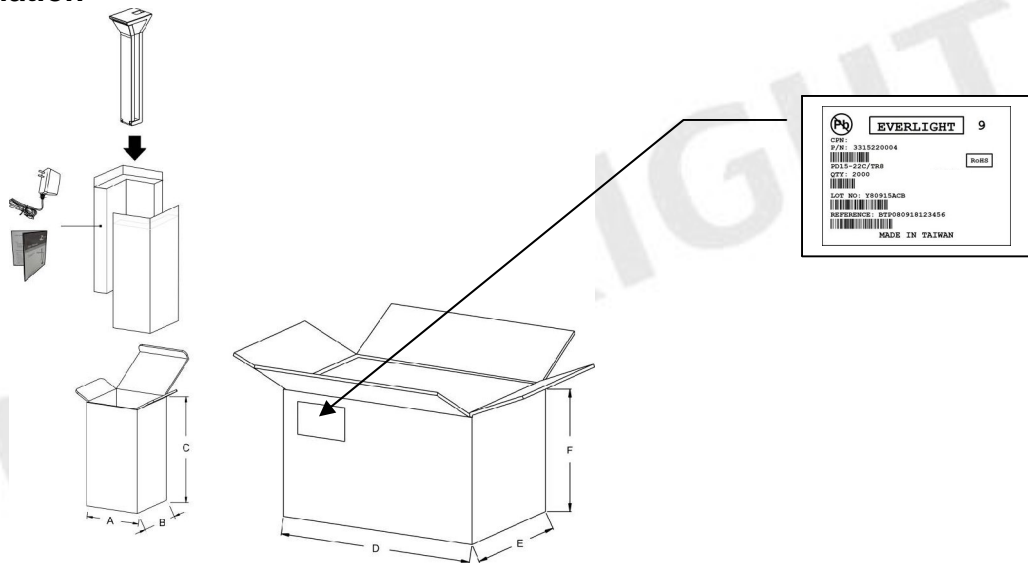

### Package Dimension

Package	Unit: mm	Unit: kg
A	140	
B	140	2.0
C	420	
Outer Box	Unit: mm	Unit: kg
D	440	
E	295	12.9
F	442	

### Packing Quantity

- 1 Luminaire / 1 Package
- 6 Packages / 1 Outer Box

**Label Explanation**



EVERLIGHT

## Operation Manual

1. Put DC Plug of Adapter into outlet of Crane-Fun
2. Put AC Plug of Adapter into outlet of wall to enter Standby Mode.

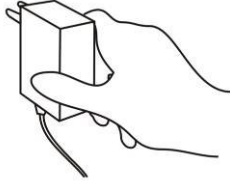
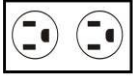

3. Click middle button once to enter **Reading Mode**, then the main lamp will be lit on.  
Click middle button again to enter **Night Light Mode**.

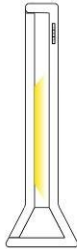
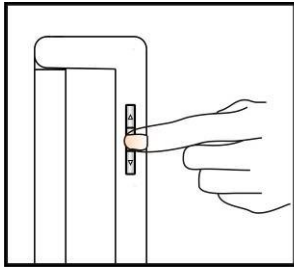

Reading  
Mode

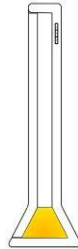

Night Light  
Mode

4. When it is in **Reading Mode**, clicking up and down arrow buttons can adjust brightness. Step dimming function:  
100%→80%→60%→40%→20%.

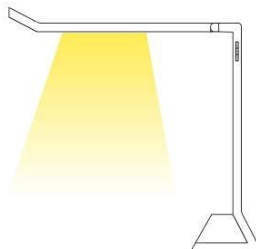
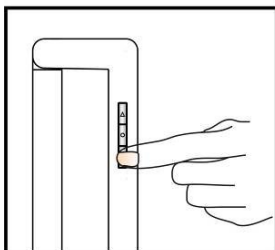
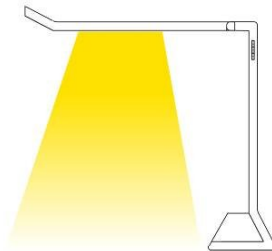
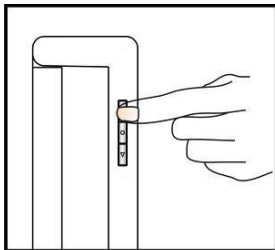

5. Press middle button lasting for 5 seconds to enter **Clock Setup Mode**.  
Click middle button to select the number.

① The last digital number will be flash continuously. Click middle button to next setup.

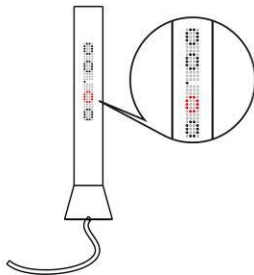
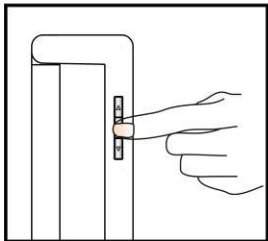
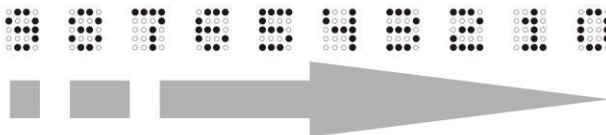
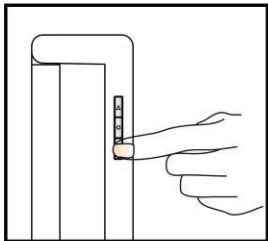
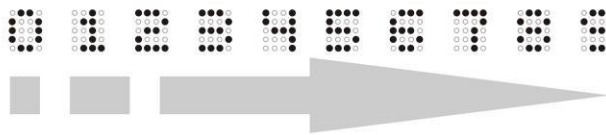
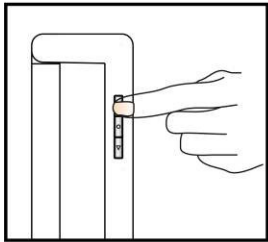
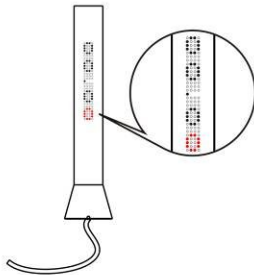
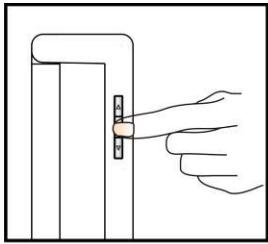

### Installation Instruction and Warning

- Do not open - no user serviceable parts inside.
- Not for use where exposed to the weather.
- Use dry clothes only, when cleaning the lamp.
- In case of a malfunction, disconnect the lamp from the power source. Contact your local service agent or a qualified technician – do not try to repair the lamp yourself.