

Data Sheet

Description

These high intensity white LED lamps are based on InGaN material technology. A blue LED die is coated by phosphor to produce white.

The typical resulting color is described by the coordinates $x = 0.41$, $y = 0.39$ using the CIE 1931 Chromaticity Diagram. These T-1¾ lamps are untinted, non-diffused, and incorporate precise optics which produce well-defined spatial radiation patterns at specific viewing cone angle.

Features

- Well defined spatial radiation pattern
- High luminous white emission
- Viewing angle: 15°, 23°, 30° and 50°
- Standoff or non-standoff leads

Package Dimensions

Package Dimension A

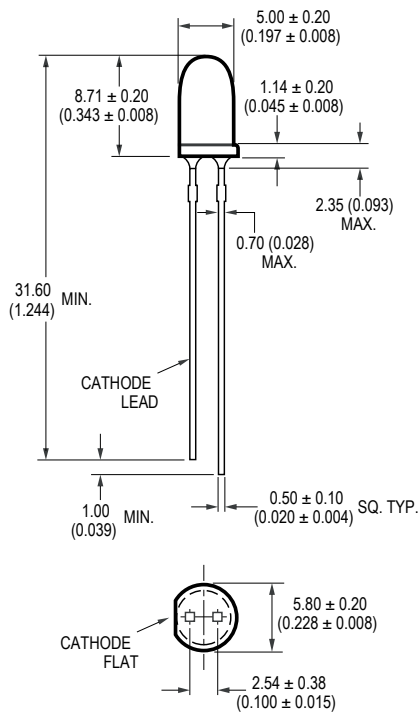

Package Dimension B

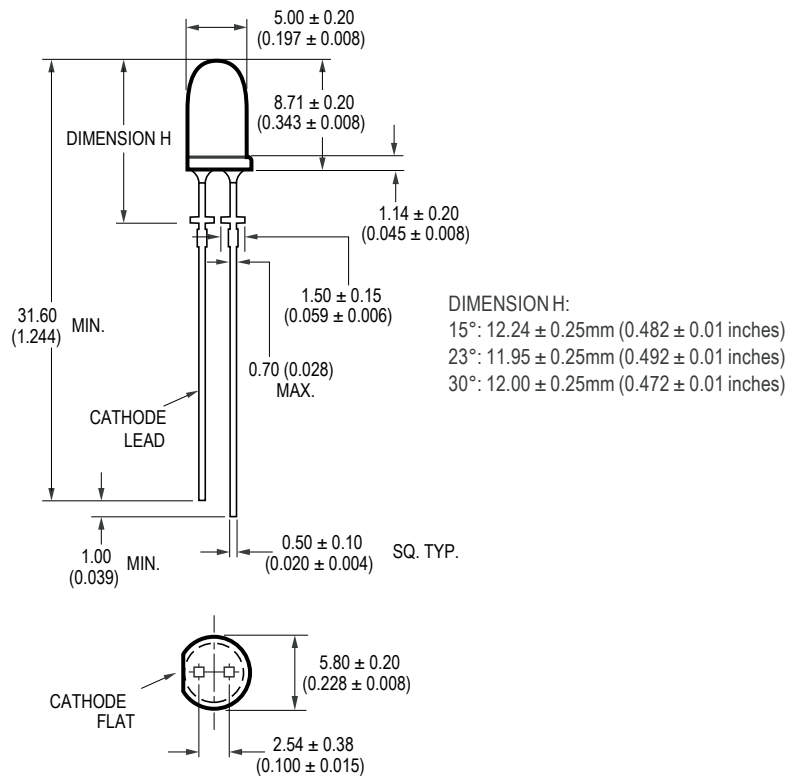

Caution: InGaN devices are Class 1C HBM ESD sensitive per JEDEC Standard. Please observe appropriate during handling and processing. Refer to Application Note AN-1142 for additional details.

HLMP-CY46/47 Package drawing

Package Dimension C

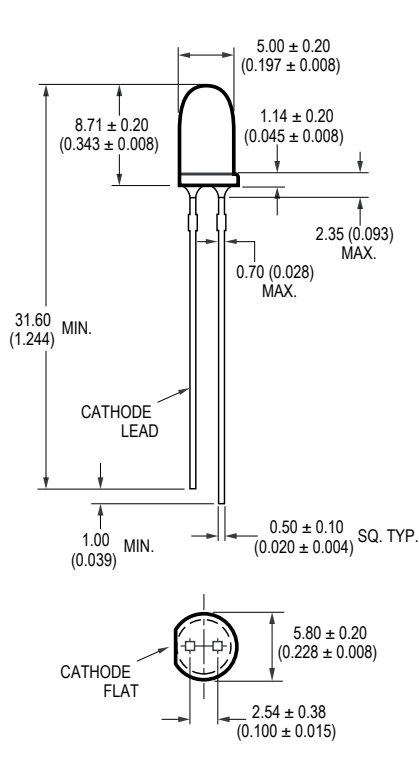

Package Dimension D

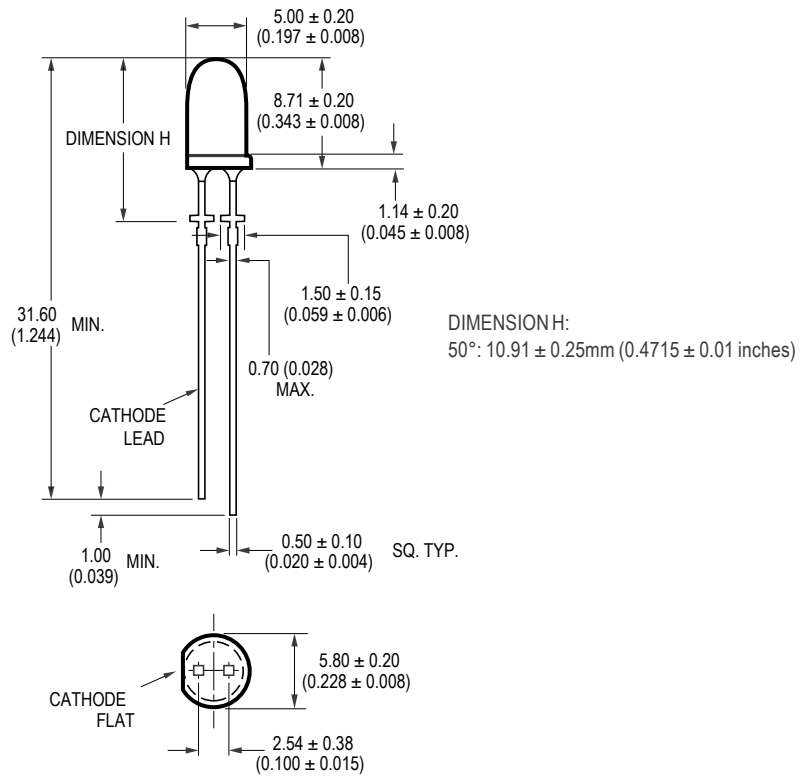

Note:

1. All dimensions are in millimeters/ inches.
2. Epoxy meniscus may extend about 1mm (0.040") down the leads.
3. If heat sinking application is required, the terminal for heat sink is anode.

Device Selection Guide

Part Number	Typical Viewing Angle (°)	Luminous Intensity (mcd) at 20mA		Standoff	Package Dimension
		Min.	Max.		
HLMP-CY11-WZ0DD	15	5500	16000	No	A
HLMP-CY12-WZ0DD	15	5500	16000	Yes	B
HLMP-CY26-VY0DD	23	4200	12000	No	A
HLMP-CY27-VY0DD	23	4200	12000	Yes	B
HLMP-CY36-UX0DD	30	3200	9300	No	A
HLMP-CY37-UX0DD	30	3200	9300	Yes	B
HLMP-CY46-TW0DD	50	2500	5500	No	C
HLMP-CY47-TW0DD	50	2500	5500	Yes	D

Tolerance for each intensity limit is ± 15%.

Part Numbering System

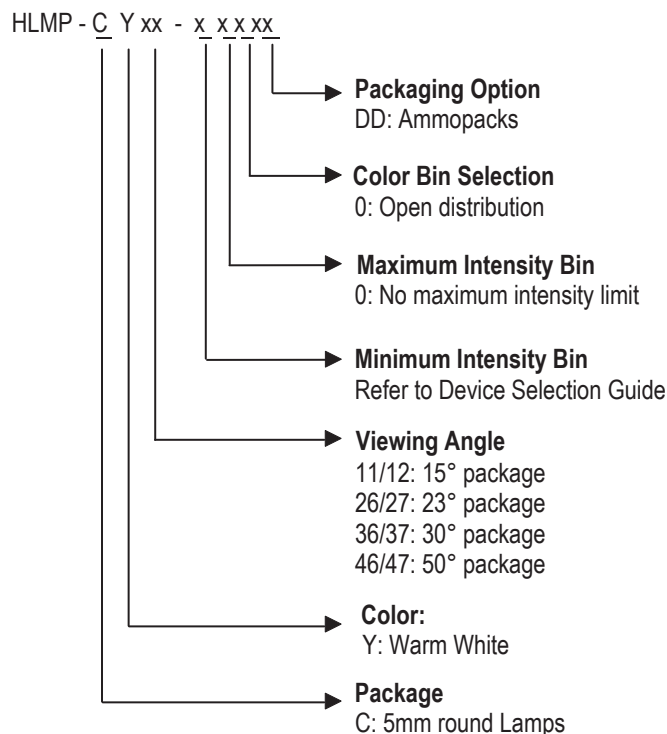

Absolute Maximum Rating $T_A = 25^\circ\text{C}$

Parameter	White	Unit
DC Forward Current	30	mA
Peak Forward Current	100 ^[1]	mA
Power Dissipation	116	mW
Reverse Voltage	5 ($I_R = 10 \mu\text{A}$)	V
LED Junction Temperature	110	°C
Operating Temperature Range	-40 to +85	°C
Storage Temperature Range	-40 to +100	°C

Notes:

- Derate linearly as shown in Figure 2
- Duty Factor 10%, frequency 1kHz.
- For long term performance with minimal light output degradation, drive current below 15mA is recommended.

Optical/ Electrical Performance at 25°C

Parameter	Symbol	Min	Typ	Max	Units	Test Condition
Forward Voltage	V_F	2.8	3.2	3.8	V	$I_F = 20 \text{ mA}$
Reverse Voltage	V_R	5.0			V	$I_R = 10 \mu\text{A}$
Thermal Resistance	$R\theta_{J-PIN}$		240		°C/W	LED junction to anode lead
Chromaticity Coordinate	X y		0.41 0.39			$I_F = 20 \text{ mA}$
Luminous Efficiency ^[3]	η_ϵ		35		lm/W	Luminous Flux/Electrical Power at $I_F = 20\text{mA}$

Notes:

- The reverse voltage of the product is equivalent to the forward voltage of the protective chip at $I_R = 10 \mu\text{A}$
- The chromaticity coordinates are derived from the CIE 1931 Chromaticity Diagram and represent the perceived color of the device.
- $\eta_\epsilon = \phi_v / I_F \times V_F$ where ϕ_v is the emitted luminous flux, I_F is electrical forward current and V_F is the forward voltage.

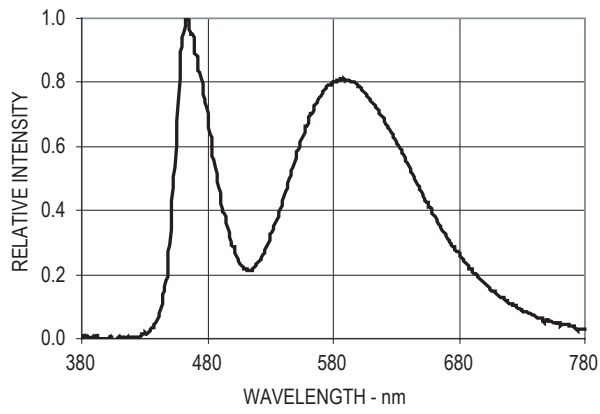

Figure 1. Relative Intensity vs. Wavelength

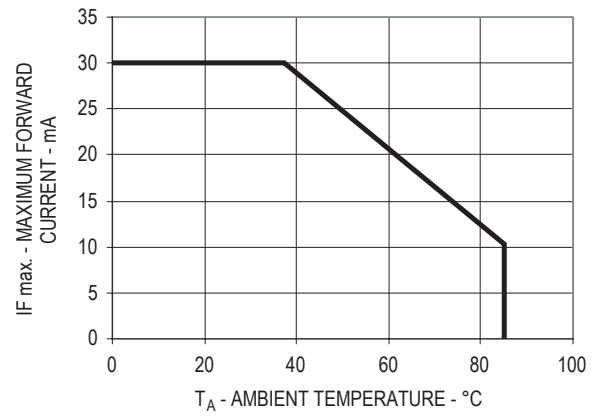

Figure 2. Forward current vs Ambient Temperature

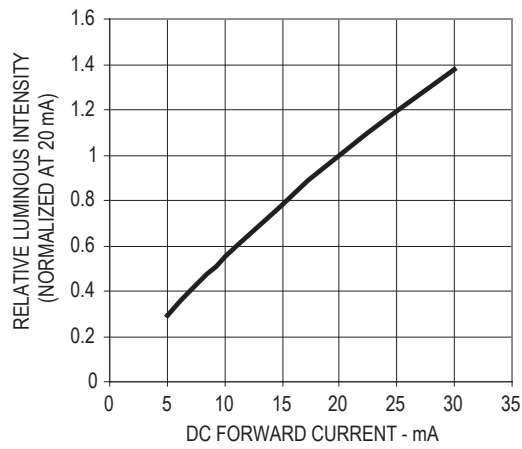

Figure 3. Relative Intensity vs Forward Current

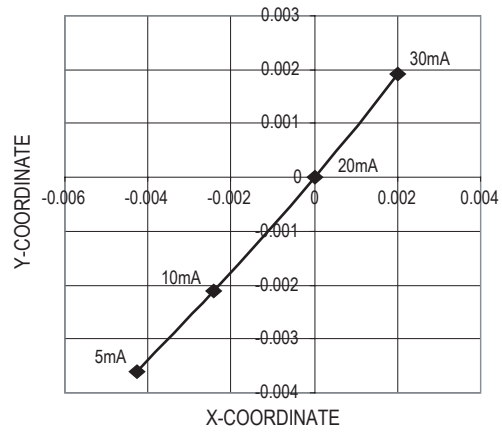

Figure 4. Chromaticity shift vs forward current

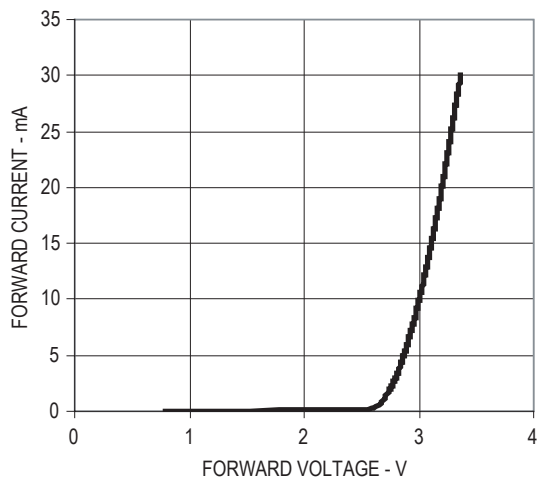

Figure 5. Forward current vs forward voltage

Radiation Pattern

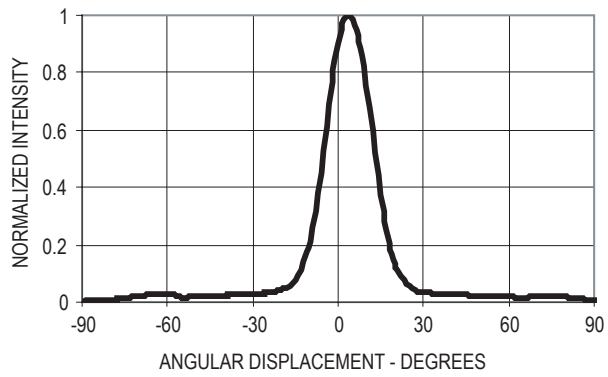

Figure 6. Radiation pattern for HLMP-CY11/12

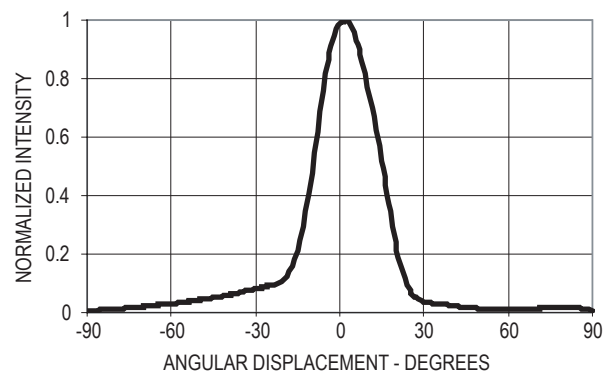

Figure 7. Radiation pattern for HLMP-CY26/27

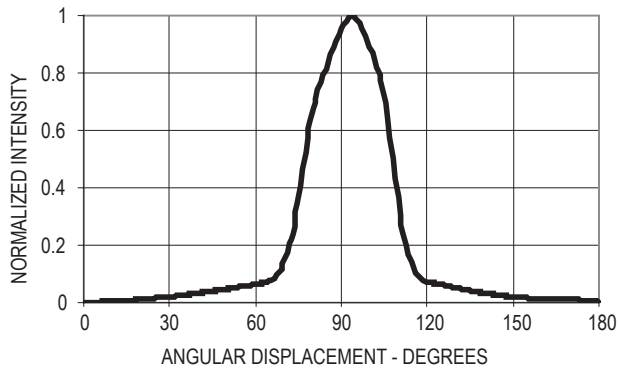

Figure 8. Radiation pattern for HLMP-CY36/37

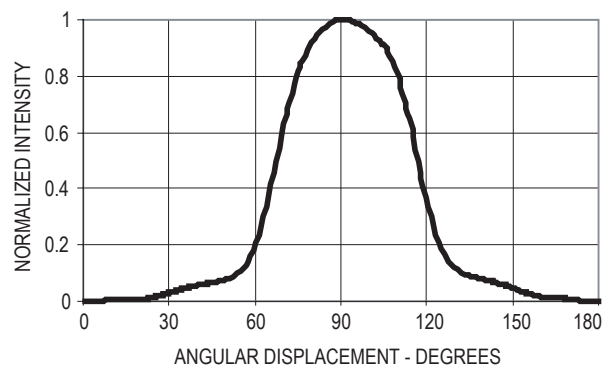

Figure 9. Radiation pattern for HLMP-CY46/47

Intensity Bin Limit Table at 20mA

Bin	Intensity (mcd) at 20 mA	
	Min	Max
T	2500	3200
U	3200	4200
V	4200	5500
W	5500	7200
X	7200	9300
Y	9300	12000
Z	12000	16000

Tolerance for each bin limit is $\pm 15\%$

Color bin limits

Rank	Chromaticity Coordinates Limits					
	1	X	0.3610	0.3988	0.3822	0.3545
	Y	0.3850	0.4116	0.3580	0.3408	0.3850
2	X	0.3988	0.4390	0.4129	0.3822	0.3988
	Y	0.4116	0.4310	0.3725	0.3580	0.4116
3	X	0.4390	0.4970	0.4588	0.4129	0.4390
	Y	0.4310	0.4466	0.3838	0.3725	0.4310

Tolerance for each bin limit is ± 0.01

Avago Warm white binning on CIE 1931 Chromaticity Diagram

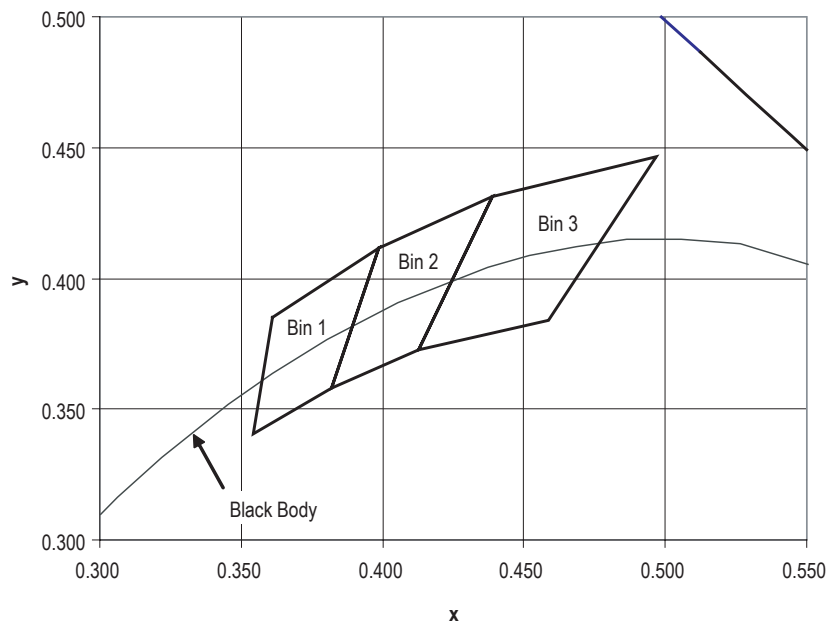

Precautions:

Lead Forming:

- The leads of an LED lamp may be preformed or cut to length prior to insertion and soldering on PC board.
- For better control, it is recommended to use proper tool to precisely form and cut the leads to applicable length rather than doing it manually.
- If manual lead cutting is necessary, cut the leads after the soldering process. The solder connection forms a mechanical ground which prevents mechanical stress due to lead cutting from traveling into LED package. This is highly recommended for hand solder operation, as the excess lead length also acts as small heat sink.

Soldering and Handling:

- Care must be taken during PCB assembly and soldering process to prevent damage to the LED component.
- LED component may be effectively hand soldered to PCB. However, it is only recommended under unavoidable circumstances such as rework. The closest manual soldering distance of the soldering heat source (soldering iron's tip) to the body is 1.59mm. Soldering the LED using soldering iron tip closer than 1.59mm might damage the LED.

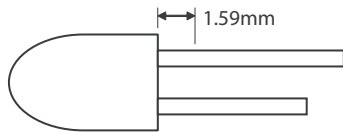

- ESD precaution must be properly applied on the soldering station and personnel to prevent ESD damage to the LED component that is ESD sensitive. Do refer to Avago application note AN 1142 for details. The soldering iron used should have grounded tip to ensure electrostatic charge is properly grounded.
- Recommended soldering condition:

	Wave Soldering [1,2]	Manual Solder Dipping
Pre-heat temperature	105 °C Max.	-
Preheat time	60 sec Max	-
Peak temperature	250 °C Max.	260 °C Max.
Dwell time	3 sec Max.	5 sec Max

Note:

- 1) Above conditions refers to measurement with thermocouple mounted at the bottom of PCB.
 - 2) It is recommended to use only bottom preheaters in order to reduce thermal stress experienced by LED.
- Wave soldering parameters must be set and maintained according to the recommended temperature and dwell time. Customer is advised to perform daily check on the soldering profile to ensure that it is always conforming to recommended soldering conditions.

Note:

1. PCB with different size and design (component density) will have different heat mass (heat capacity). This might cause a change in temperature experienced by the board if same wave soldering setting is used. So, it is recommended to re-calibrate the soldering profile again before loading a new type of PCB.
2. Avago Technologies' high brightness LED are using high efficiency LED die with single wire bond as shown below. Customer is advised to take extra precaution during wave soldering to ensure that the maximum wave temperature does not exceed 250°C and the solder contact time does not exceeding 3sec. Over-stressing the LED during soldering process might cause premature failure to the LED due to delamination.

Avago Technologies LED configuration

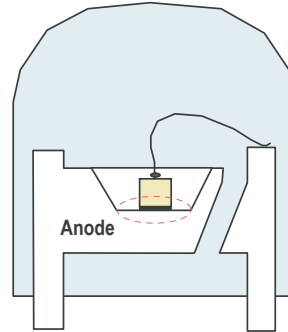

InGaN Device

Note: Electrical connection between bottom surface of LED die and the lead frame is achieved through conductive paste.

- Any alignment fixture that is being applied during wave soldering should be loosely fitted and should not apply weight or force on LED. Non metal material is recommended as it will absorb less heat during wave soldering process.
- At elevated temperature, LED is more susceptible to mechanical stress. Therefore, PCB must allowed to cool down to room temperature prior to handling, which includes removal of alignment fixture or pallet.
- If PCB board contains both through hole (TH) LED and other surface mount components, it is recommended that surface mount components be soldered on the top side of the PCB. If surface mount need to be on the bottom side, these components should be soldered using reflow soldering prior to insertion the TH LED.
- Recommended PC board plated through holes (PTH) size for LED component leads.

LED component lead size	Diagonal	Plated through hole diameter
0.45 x 0.45 mm (0.018x 0.018 inch)	0.636 mm (0.025 inch)	0.98 to 1.08 mm (0.039 to 0.043 inch)
0.50 x 0.50 mm (0.020x 0.020 inch)	0.707 mm (0.028 inch)	1.05 to 1.15 mm (0.041 to 0.045 inch)

- Over-sizing the PTH can lead to twisted LED after clinching. On the other hand under sizing the PTH can cause difficulty inserting the TH LED.

Packaging Box for Ammo Packs

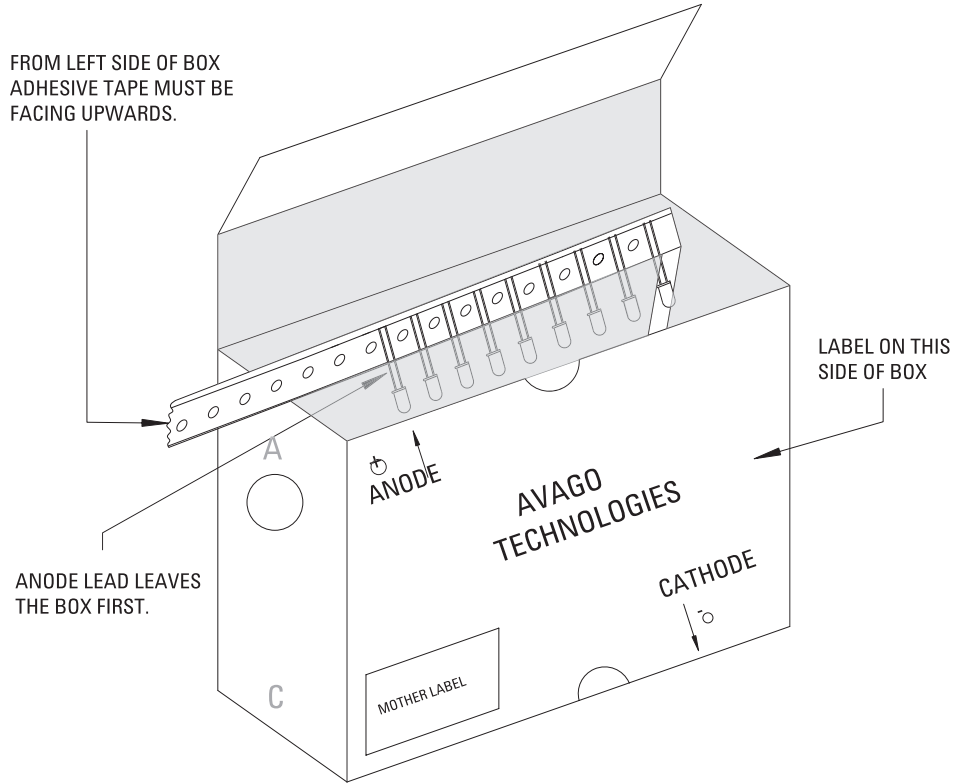









Note: For InGaN device, the ammo pack packaging box contain ESD logo

Packaging Label

(i) Avago Mother Label: (Available on packaging box of ammo pack and shipping box)

AVAGO TECHNOLOGIES	
(1P) Item: Part Number	STANDARD LABEL LS0002
	RoHS Compliant
(1T) Lot: Lot Number	e1 max temp 250C
	(Q) QTY: Quantity
LPN	
	CAT: Intensity Bin
(9D) MFG Date: Manufacturing Date	
	BIN: Refer to below information
(P) Customer Item:	REV:
(V) Vendor ID	DeptID:
Made In: Country of Origin	

(ii) Avago Baby Label (Only available on bulk packaging)

AVAGO TECHNOLOGIES		RoHS Compliant e1 max temp 250C
PART #: Part Number		
LOT#: Lot Number		
MFG DATE: Manufacturing Date		QUANTITY: Packing Quantity
C/O: Country of Origin		
Customer P/N:		CAT: Intensity Bin
Supplier Code:		
		BIN: Refer to below information
		
		DATECODE: Date Code
		

Acronyms and Definition:

BIN:

(i) Color bin only or VF bin only

(Applicable for part number with color bins but without VF bin OR part number with VF bins and no color bin)

OR

(ii) Color bin incorporated with VF Bin

(Applicable for part number that have both color bin and VF bin)

Example:

(i) Color bin only or VF bin only

BIN: 2 (represent color bin 2 only)

BIN: VB (represent VF bin "VB" only)

(ii) Color bin incorporate with VF Bin

BIN: 2VB

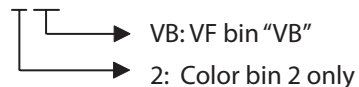

DISCLAIMER

AVAGO'S PRODUCTS AND SOFTWARE ARE NOT SPECIFICALLY DESIGNED, MANUFACTURED OR AUTHORIZED FOR SALE AS PARTS, COMPONENTS OR ASSEMBLIES FOR THE PLANNING, CONSTRUCTION, MAINTENANCE OR DIRECT OPERATION OF A NUCLEAR FACILITY OR FOR USE IN MEDICAL DEVICES OR APPLICATIONS. CUSTOMER IS SOLELY RESPONSIBLE, AND WAIVES ALL RIGHTS TO MAKE CLAIMS AGAINST AVAGO OR ITS SUPPLIERS, FOR ALL LOSS, DAMAGE, EXPENSE OR LIABILITY IN CONNECTION WITH SUCH USE.

For product information and a complete list of distributors, please go to our web site: www.avagotech.com