

PTC THERMISTORS: TYPE YP

WIRED DISC

DESCRIPTION:

A range of radially-wired PTC disc thermistors with black silicone resin coating.

FEATURES:

- Designed for general purpose over-current, over-voltage and direct over-temperature protection
- Wide range of operating current & voltage levels
- Approved to CECC 44 001 - 002 (certificate E1254/F)
- Excellent stability
- Fail-safe operation
- Solid state
- High performance barium titanate ceramic
- Suitable for automatic PCB insertion

OPTIONS:

- Non-standard resistances and tolerances
- Resistance matching
- Non-standard wire lengths
- Other wire configurations

PACKAGING:

All types in the YP range are available loose-packed, as shown in the drawing. Devices are also available on bandolier (tape & reel): types with diameter $a < 13.5\text{mm}$ comply with IEC 286-2.

To identify the packaging required, replace X in the product codes shown overleaf as follows:

Bandoliered T
Loose-packed N

Devices are also available with dimension H_0 (as specified in IEC 286-2) of 18mm instead of the standard 16mm. These parts can be ordered by adding the suffix 18 to the code e.g. YPALO.80T18.

Pack quantities:

Loose packed 500/box
Bandoliered
a $< 13.5\text{mm}$ 1000/reel (0.5" pitch)
a $\geq 13.5\text{mm}$ 500/reel (1" pitch)

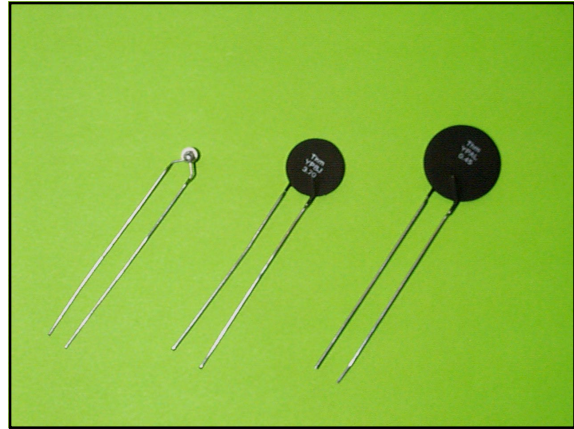

DIMENSIONS:

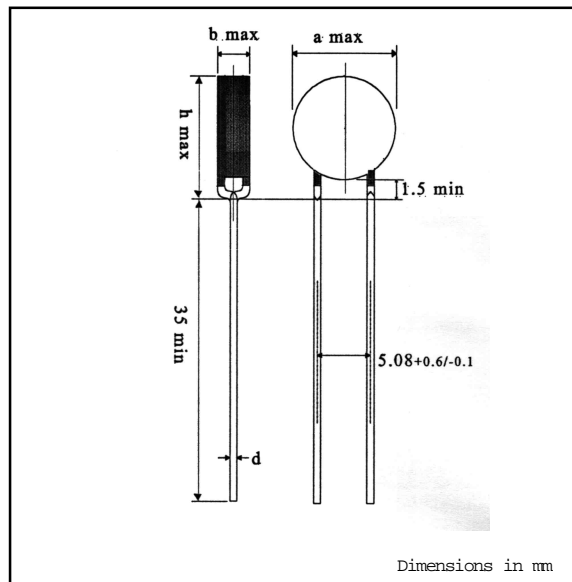

DATA:

Tolerance on R_{25} $\pm 25\%$

Ambient temperature range:

at maximum voltage 0 to $+60^\circ\text{C}$

at zero voltage -25 to $+125^\circ\text{C}$

Lead wire material Solder-coated brass

Body coating Silicone resin
(except types YPEL3500X & YPEL6250X)

Data sheet D-YP-2

BOWTHORPE THERMOMETRICS
Crown Industrial Estate, Priorswood Rd
Taunton, Somerset TA2 8QY UK
Tel +44 (0)1823 335200
Fax +44 (0)1823 332637
Email: info@thermometrics.com

THERMOMETRICS, INC.
808 US Highway 1
Edison, New Jersey 08817-4695 USA
Tel +1 (732) 287 2870
Fax +1 (732) 287 8847
Email: sales@thmusa.com

KEYSTONE THERMOMETRICS CORP
967 Windfall Road
St Marys, Pennsylvania 15857-3397 USA
Tel +1 (814) 834 9140
Fax +1 (814) 781 7969
Email: sales@keystone-usa.com

DAEWOO THERMOMETRICS
#302 3rd floor Bethel Bldg,
324-1 Yangjae-dong, Seocho-Ku, Seoul, Korea
Tel +82 (0)2 5765232, 5233
Fax +82 (0)2 576 5234
Email: thmkorea@bora.dacom.co.kr

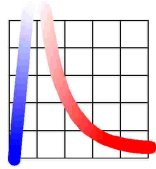

PTC THERMISTORS: TYPE YP

WIRED DISC

Group	Code	R ₂₅ Ω	I _{nt} A	I _t A	I _{mo} A	I _r mA	a mm	b mm	l mm	d mm	Brand code	CECC approval
V _{max} = 30Vdc T _b =120 C	YPAL0.45X	0.45	1.3	2.6	8	115	17.5	3.5	21	0.6	ThM YPAL 0.45	
	YPAL0.80X	0.8	0.85	1.7	5.5	80	13.5	3.5	17	0.6	ThM YPAL 0.80	
	YPAL1.20X	1.2	0.6	1.2	4.3	70	11	3.5	14.5	0.6	ThM YPAL 1.20	
	YPAL1.80X	1.8	0.45	0.9	3	60	9	3.5	12.5	0.6	ThM YPAL 1.80	
	YPAL4.60X	4.6	0.25	0.5	1	45	6.5	3.5	10	0.6	K	
	YPAL0013X	13	0.12	0.24	0.7	25	4	3.5	7.5	0.5	L	
V _{max} = 80Vdc T _b =80 C	YPBJ2.30X	2.3	0.245	0.5	8	40	17.5	3.5	21	0.6	ThM YPBJ 2.30	
	YPBJ3.70X	3.7	0.17	0.35	5.5	30	13.5	3.5	17	0.6	ThM YPBJ 3.70	
	YPBJ5.60X	5.6	0.13	0.265	4.3	25	11	3.5	14.5	0.6	ThM YPBJ 5.60	Yes
	YPBJ9.40X	9.4	0.09	0.19	3	20	9	3.5	12.5	0.6	ThM YPBJ 9.40	Yes
	YPBJ0025X	25	0.05	0.11	1	16	6.5	3.5	10	0.6	M	Yes
	YPBJ0055X	55	0.03	0.06	0.7	12	4	3.5	7.5	0.5	N	Yes
V _{max} = 80Vdc T _b =120 C	YPBL2.30X	2.3	0.45	0.9	8	40	17.5	3.5	21	0.6	ThM YPBL 2.30	
	YPBL3.70X	3.7	0.32	0.64	5.5	30	13.5	3.5	17	0.6	ThM YPBL 3.70	
	YPBL5.60X	5.6	0.25	0.5	4.3	25	11	3.5	14.5	0.6	ThM YPBL 5.60	Yes
	YPBL9.40X	9.4	0.15	0.3	3	20	9	3.5	12.5	0.6	ThM YPBL 9.40	Yes
	YPBL0025X	25	0.085	0.17	1	16	6.5	3.5	10	0.6	O	Yes
	YPBL0055X	55	0.05	0.1	0.7	12	4	3.5	7.5	0.5	P	Yes
V _{max} =265Vrms T _b =80 C	YPCJ0006X	6	0.17	0.35	4.1	10	17.5	5	21	0.6	ThM YPCJ 0006	
	YPCJ0010X	10	0.11	0.23	2.2	8	13.5	5	17	0.6	ThM YPCJ 0010	
	YPCJ0015X	15	0.09	0.18	1.5	6	11	5	14.5	0.6	ThM YPCJ 0015	Yes
	YPCJ0025X	25	0.06	0.13	1	5	9	5	12.5	0.6	ThM YPCJ 0025	Yes
	YPCJ0070X	70	0.03	0.07	0.4	4	6.5	5	10	0.6	Q	Yes
	YPCJ0150X	150	0.015	0.04	0.2	3	4	5	7.5	0.5	R	Yes
V _{max} =265Vrms T _b =120 C	YPCL0006X	6	0.33	0.66	4.1	15	17.5	5	21	0.6	ThM YPCL 0006	
	YPCL0010X	10	0.2	0.4	2.2	13	13.5	5	17	0.6	ThM YPCL 0010	
	YPCL0015X	15	0.14	0.28	1.5	10	11	5	14.5	0.6	ThM YPCL 0015	Yes
	YPCL0025X	25	0.1	0.2	1	9	9	5	12.5	0.6	ThM YPCL0025	Yes
	YPCL0035X	35	0.08	0.16	1	9	9	5	12.5	0.6	ThM YPCL 0035	Yes
	YPCL0045X	45	0.07	0.14	1	9	9	5	12.5	0.6	ThM YPCL 0045	Yes
	YPCL0055X	55	0.06	0.125	1	9	9	5	12.5	0.6	ThM YPCL 0055	Yes
	YPCL0065X	65	0.055	0.11	1	9	9	5	12.5	0.6	ThM YPCL 0065	Yes
	YPCL0070X	70	0.055	0.11	0.4	6	6.5	5	10	0.6	S	Yes
	YPCL0120X	120	0.035	0.07	0.4	5	6.5	5	10	0.6	Z	Yes
	YPCL0150X	150	0.03	0.06	0.2	5	4	5	7.5	0.5	T	Yes
V _{max} =420Vrms T _b =120 C	YDLO600X	600	0.021	0.039	0.2	3	6.5	5	10	0.6	U	Yes
V _{max} =550Vrms T _b =120 C	YPEK1200X	1200	0.015	0.03	0.1	3	6.5	5	10	0.6	V	Yes
	YPEK1500X	1500	0.012	0.024	0.1	2	6.5	5	10	0.6	W	Yes
	YPEL3500X	3500	0.008	0.018	0.25	2.5	4	4	7.5	0.5	X	Yes
	YPEL6250X	6250	0.006	0.014	0.15	1.5	4	4	7.5	0.5	Y	Yes

V _{max}	Maximum operating voltage	I _t	Minimum trip current (25 C ambient)
T _b	Switching temperature	I _{mo}	Maximum overload current
R ₂₅	Resistance at 25 C	I _r	Residual current (25 C ambient)
I _{nt}	Maximum current without tripping (25 C ambient)		

Data sheet D-YP-2

BOWTHORPE THERMOMETRICS
Crown Industrial Estate, Priorswood Rd
Taunton, Somerset TA2 8QY UK
Tel +44 (0)1823 335200
Fax +44 (0)1823 332637
Email: info@thermometrics.com

THERMOMETRICS, INC.
808 US Highway 1
Edison, New Jersey 08817-4695 USA
Tel +1 (732) 287 2870
Fax +1 (732) 287 8847
Email: sales@thmusa.com

KEYSTONE THERMOMETRICS CORP
967 Windfall Road
St Marys, Pennsylvania 15857-3397 USA
Tel +1 (814) 834 9140
Fax +1 (814) 781 7969
Email: sales@keystone-usa.com

DAEWOO THERMOMETRICS
#302 3rd floor Bethel Bldg,
324-1 Yangjae-dong, Seocho-Ku, Seoul, Korea
Tel +82 (0)2 5765232, 5233
Fax +82 (0)2 576 5234
Email: thmkorea@bora.dacom.co.kr

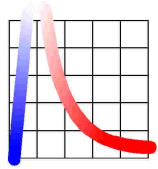

PTC THERMISTORS: TYPE YP

WIRED DISC

TRIPPING TIMES:

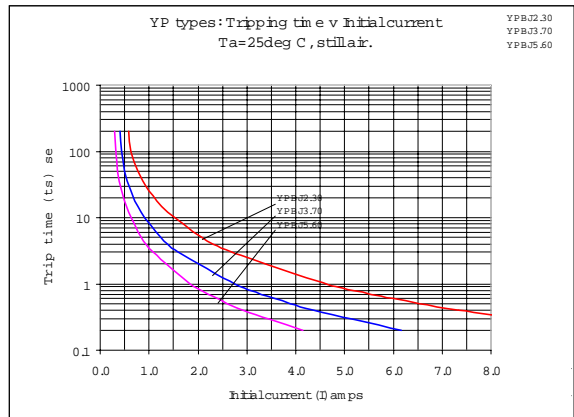
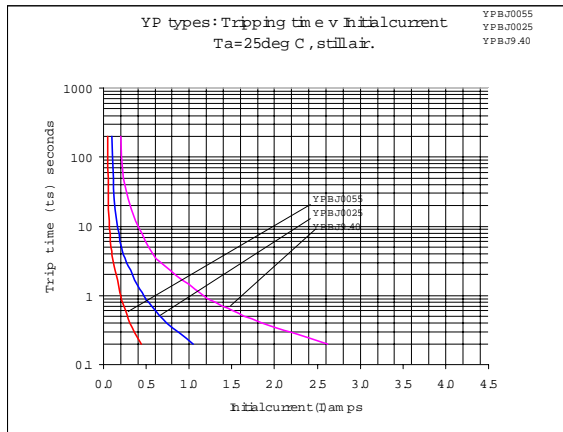
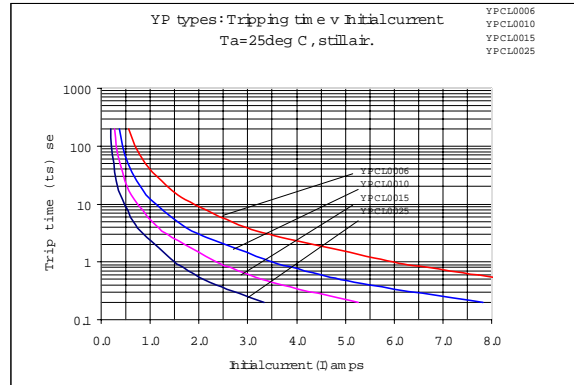
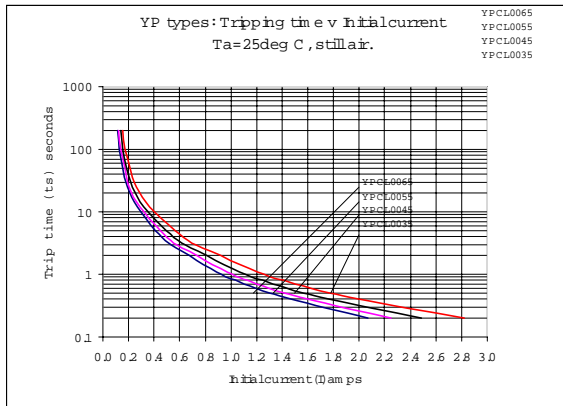
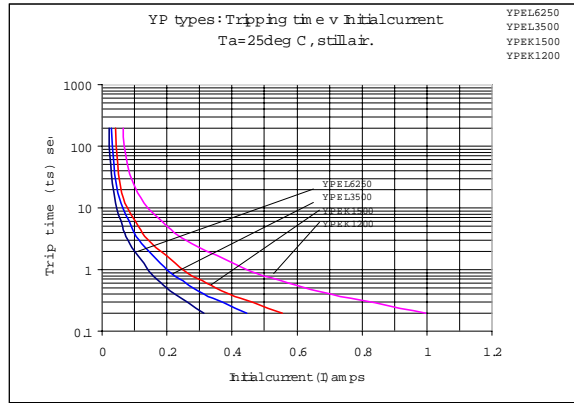
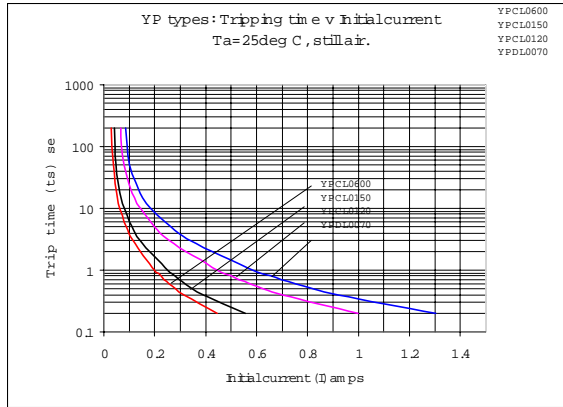

Data sheet D-YP-2

BOWTHORPE THERMOMETRICS
Crown Industrial Estate, Priorswood Rd
Taunton, Somerset TA2 8QY UK
Tel +44 (0)1823 335200
Fax +44 (0)1823 332637
Email: info@thermometrics.com

THERMOMETRICS, INC.
808 US Highway 1
Edison, New Jersey 08817-4695 USA
Tel +1 (732) 287 2870
Fax +1 (732) 287 8847
Email: sales@thmusa.com

KEYSTONE THERMOMETRICS CORP
967 Windfall Road
St Marys, Pennsylvania 15857-3397 USA
Tel +1 (814) 834 9140
Fax +1 (814) 781 7969
Email: sales@keystone-usa.com

DAEWOO THERMOMETRICS
#302 3rd floor Bethel Bldg,
324-1 Yangjae-dong, Seocho-Ku, Seoul, Korea
Tel +82 (0)2 5765232, 5233
Fax +82 (0)2 576 5234
Email: thmkorea@bora.dacom.co.kr

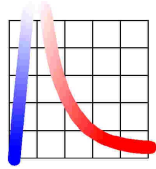

PTC THERMISTORS: TYPE YP

WIRED DISC

