

# Cree® XLamp® XB-D White LEDs



## TABLE OF CONTENTS

Introduction..... 1

Bin and Order-Code Format ..... 2

Performance Groups – Brightness ( $T_j = 85\text{ }^\circ\text{C}$ ) ..... 2

Performance Groups – Chromaticity ..... 3

Cree’s Standard Chromaticity Regions Plotted on the 1931 CIE Curve..... 6

Cree’s Standard Kit Codes Plotted on ANSI Standard Chromaticity Regions ..... 7

Cree’s Standard Chromaticity Kits .....11

Standard Kits, Codes and Bins

    XB-D ANSI Cool White,  $T_j = 85\text{ }^\circ\text{C}$  .....11

    XB-D Neutral White,  $T_j = 85\text{ }^\circ\text{C}$  .....12

    XB-D Warm White,  $T_j = 85\text{ }^\circ\text{C}$  .....13

## INTRODUCTION

This document describes the product nomenclature required to select and order Cree’s XLamp XB-D LEDs. XLamp XB-D LEDs are tested and sorted into bins which are then combined into orderable kits, identified by an order code.

All XLamp LEDs are tested and sorted by color and brightness into a unique bin. Each bin contains LEDs from only one color and brightness group and is uniquely identified by a bin code. White XLamp LEDs are sorted by chromaticity (color) and luminous flux (brightness). Color XLamp LEDs are sorted by dominant wavelength (color) and luminous or radiant flux (brightness). LEDs are shipped in reels containing LEDs from a single bin and labeled with the corresponding bin code. XLamp LED packaging details are provided in product data sheets.

Kits contain LEDs from a number of similar bins and are fully defined by their order codes. A full explanation of the order codes for XLamp XB Family LEDs, as well as a list of standard order codes, is provided in this document.

**BIN AND ORDER-CODE FORMAT**

Bin codes and order codes for XB-D White LEDs are configured in the following manner:

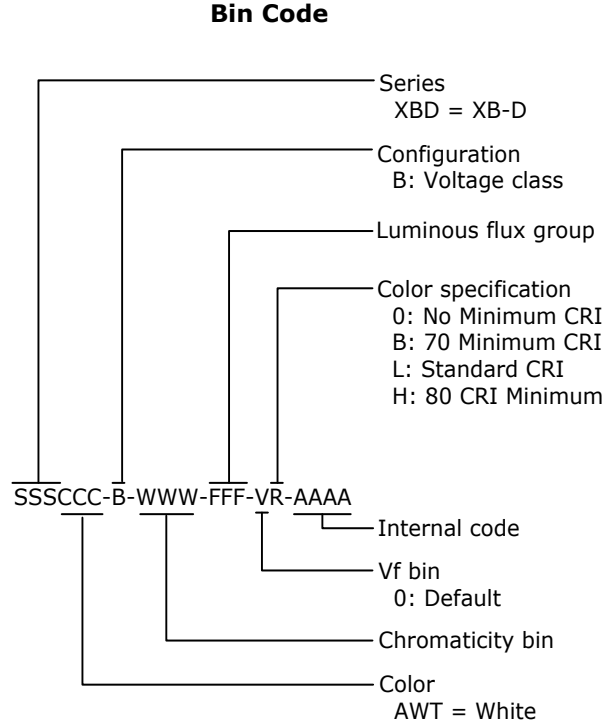
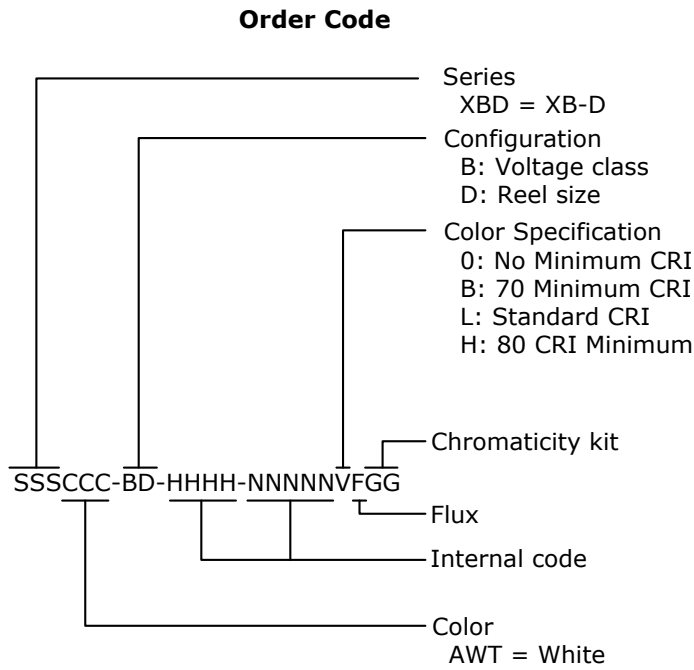

Example Order Code: XBDAWT-00-0000-00000HAE7

Example Bin Code: XBDAWT-0-7A3-Q20-0H-0001

**PERFORMANCE GROUPS – BRIGHTNESS (T<sub>j</sub> = 85 °C)**

XLamp XB-D White LEDs are tested for luminous flux and placed into one of the following luminous-flux groups.

Group Code	Min. Luminous Flux @ 350 mA (lm)	Max. Luminous Flux @ 350 mA (lm)
P2	67.2	73.9
P3	73.9	80.6
P4	80.6	87.4
Q2	87.4	93.9
Q3	93.9	100
Q4	100	107
Q5	107	114
R2	114	122
R3	122	130
R4	130	139
R5	139	148
S2	148	156

**PERFORMANCE GROUPS – CHROMATICITY**

Region	x	y	Region	x	y	Region	x	y	Region	x	y
0A	0.2950	0.2970	0B	0.2920	0.3060	0C	0.2984	0.3133	0D	0.2984	0.3133
	0.2920	0.3060		0.2895	0.3135		0.2962	0.3220		0.3048	0.3207
	0.2984	0.3133		0.2962	0.3220		0.3028	0.3304		0.3068	0.3113
	0.3009	0.3042		0.2984	0.3133		0.3048	0.3207		0.3009	0.3042
0R	0.2980	0.2880	0S	0.2895	0.3135	0T	0.2962	0.3220	0U	0.3037	0.2937
	0.2950	0.2970		0.2870	0.3210		0.2937	0.3312		0.3009	0.3042
	0.3009	0.3042		0.2937	0.3312		0.3005	0.3415		0.3068	0.3113
	0.3037	0.2937		0.2962	0.3220		0.3028	0.3304		0.3093	0.2993
1A	0.3048	0.3207	1B	0.3028	0.3304	1C	0.3115	0.3391	1D	0.3130	0.3290
	0.3130	0.3290		0.3115	0.3391		0.3205	0.3481		0.3213	0.3373
	0.3144	0.3186		0.3130	0.3290		0.3213	0.3373		0.3221	0.3261
	0.3068	0.3113		0.3048	0.3207		0.3130	0.3290		0.3144	0.3186
1R	0.3068	0.3113	1S	0.3005	0.3415	1T	0.3099	0.3509	1U	0.3144	0.3186
	0.3144	0.3186		0.3099	0.3509		0.3196	0.3602		0.3221	0.3261
	0.3161	0.3059		0.3115	0.3391		0.3205	0.3481		0.3231	0.3120
	0.3093	0.2993		0.3028	0.3304		0.3115	0.3391		0.3161	0.3059
2A	0.3215	0.3350	2B	0.3207	0.3462	2C	0.3290	0.3538	2D	0.3290	0.3417
	0.3290	0.3417		0.3290	0.3538		0.3376	0.3616		0.3371	0.3490
	0.3290	0.3300		0.3290	0.3417		0.3371	0.3490		0.3366	0.3369
	0.3222	0.3243		0.3215	0.3350		0.3290	0.3417		0.3290	0.3300
2R	0.3222	0.3243	2S	0.3196	0.3602	2T	0.3290	0.3690	2U	0.3290	0.3300
	0.3290	0.3300		0.3290	0.3690		0.3381	0.3762		0.3366	0.3369
	0.3290	0.3180		0.3290	0.3538		0.3376	0.3616		0.3361	0.3245
	0.3231	0.3120		0.3207	0.3462		0.3290	0.3538		0.3290	0.3180
3A	0.3371	0.3490	3B	0.3376	0.3616	3C	0.3463	0.3687	3D	0.3451	0.3554
	0.3451	0.3554		0.3463	0.3687		0.3551	0.3760		0.3533	0.3620
	0.3440	0.3427		0.3451	0.3554		0.3533	0.3620		0.3515	0.3487
	0.3366	0.3369		0.3371	0.3490		0.3451	0.3554		0.3440	0.3427
3R	0.3366	0.3369	3S	0.3381	0.3762	3T	0.3480	0.3840	3U	0.3440	0.3428
	0.3440	0.3428		0.3480	0.3840		0.3571	0.3907		0.3515	0.3487
	0.3429	0.3307		0.3463	0.3687		0.3551	0.3760		0.3495	0.3339
	0.3361	0.3245		0.3376	0.3616		0.3463	0.3687		0.3429	0.3307
4A	0.3530	0.3597	4B	0.3548	0.3736	4C	0.3641	0.3804	4D	0.3615	0.3659
	0.3615	0.3659		0.3641	0.3804		0.3736	0.3874		0.3702	0.3722
	0.3590	0.3521		0.3615	0.3659		0.3702	0.3722		0.3670	0.3578
	0.3512	0.3465		0.3530	0.3597		0.3615	0.3659		0.3590	0.3521
4R	0.3512	0.3465	4S	0.3571	0.3907	4T	0.3668	0.3957	4U	0.3590	0.3521
	0.3590	0.3521		0.3668	0.3957		0.3771	0.4034		0.3670	0.3578
	0.3567	0.3389		0.3641	0.3804		0.3736	0.3874		0.3640	0.3440
	0.3495	0.3339		0.3548	0.3736		0.3641	0.3804		0.3567	0.3389

**PERFORMANCE GROUPS – CHROMATICITY (CONTINUED)**

Region	x	y	Region	x	y	Region	x	y	Region	x	y
5A1	0.3670	0.3578	5A2	0.3686	0.3649	5A3	0.3744	0.3685	5A4	0.3726	0.3612
	0.3686	0.3649		0.3702	0.3722		0.3763	0.3760		0.3744	0.3685
	0.3744	0.3685		0.3763	0.3760		0.3825	0.3798		0.3804	0.3721
	0.3726	0.3612		0.3744	0.3685		0.3804	0.3721		0.3783	0.3646
5B1	0.3702	0.3722	5B2	0.3719	0.3797	5B3	0.3782	0.3837	5B4	0.3763	0.3760
	0.3719	0.3797		0.3736	0.3874		0.3802	0.3916		0.3782	0.3837
	0.3782	0.3837		0.3802	0.3916		0.3869	0.3958		0.3847	0.3877
	0.3763	0.3760		0.3782	0.3837		0.3847	0.3877		0.3825	0.3798
5C1	0.3825	0.3798	5C2	0.3847	0.3877	5C3	0.3912	0.3917	5C4	0.3887	0.3836
	0.3847	0.3877		0.3869	0.3958		0.3937	0.4001		0.3912	0.3917
	0.3912	0.3917		0.3937	0.4001		0.4006	0.4044		0.3978	0.3958
	0.3887	0.3836		0.3912	0.3917		0.3978	0.3958		0.3950	0.3875
5D1	0.3783	0.3646	5D2	0.3804	0.3721	5D3	0.3863	0.3758	5D4	0.3840	0.3681
	0.3804	0.3721		0.3825	0.3798		0.3887	0.3836		0.3863	0.3758
	0.3863	0.3758		0.3887	0.3836		0.3950	0.3875		0.3924	0.3794
	0.3840	0.3681		0.3863	0.3758		0.3924	0.3794		0.3898	0.3716
5R	0.3670	0.3578	5S	0.3771	0.4034	5T	0.3916	0.4127	5U	0.3783	0.3646
	0.3783	0.3646		0.3916	0.4127		0.4064	0.4221		0.3898	0.3716
	0.3743	0.3502		0.3869	0.3958		0.4006	0.4044		0.3848	0.3565
	0.3640	0.3440		0.3736	0.3874		0.3869	0.3958		0.3743	0.3502
6A1	0.3889	0.3690	6A2	0.3915	0.3768	6A3	0.3981	0.3800	6A4	0.3953	0.3720
	0.3915	0.3768		0.3941	0.3848		0.4010	0.3882		0.3981	0.3800
	0.3981	0.3800		0.4010	0.3882		0.4080	0.3916		0.4048	0.3832
	0.3953	0.3720		0.3981	0.3800		0.4048	0.3832		0.4017	0.3751
6B1	0.3941	0.3848	6B2	0.3968	0.3930	6B3	0.4040	0.3966	6B4	0.4010	0.3882
	0.3968	0.3930		0.3996	0.4015		0.4071	0.4052		0.4040	0.3966
	0.4040	0.3966		0.4071	0.4052		0.4146	0.4089		0.4113	0.4001
	0.4010	0.3882		0.4040	0.3966		0.4113	0.4001		0.4080	0.3916
6C1	0.4080	0.3916	6C2	0.4113	0.4001	6C3	0.4186	0.4037	6C4	0.4150	0.3950
	0.4113	0.4001		0.4146	0.4089		0.4222	0.4127		0.4186	0.4037
	0.4186	0.4037		0.4222	0.4127		0.4299	0.4165		0.4259	0.4073
	0.4150	0.3950		0.4186	0.4037		0.4259	0.4073		0.4221	0.3984
6D1	0.4017	0.3751	6D2	0.4048	0.3832	6D3	0.4116	0.3865	6D4	0.4082	0.3782
	0.4048	0.3832		0.4080	0.3916		0.4150	0.3950		0.4116	0.3865
	0.4116	0.3865		0.4150	0.3950		0.4221	0.3984		0.4183	0.3898
	0.4082	0.3782		0.4116	0.3865		0.4183	0.3898		0.4147	0.3814

**PERFORMANCE GROUPS – CHROMATICITY (CONTINUED)**

Region	x	y	Region	x	y	Region	x	y	Region	x	y
6R	0.3889	0.3690	6S	0.4054	0.4191	6T	0.4217	0.4273	6U	0.4017	0.3751
	0.4017	0.3751		0.4217	0.4273		0.4382	0.4356		0.4147	0.3814
	0.3957	0.3596		0.4146	0.4089		0.4299	0.4165		0.4077	0.3652
	0.3840	0.3540		0.3996	0.4015		0.4146	0.4089		0.3957	0.3596
7A1	0.4147	0.3814	7A2	0.4183	0.3898	7A3	0.4242	0.3919	7A4	0.4203	0.3833
	0.4183	0.3898		0.4221	0.3984		0.4281	0.4006		0.4242	0.3919
	0.4242	0.3919		0.4281	0.4006		0.4342	0.4028		0.4300	0.3939
	0.4203	0.3833		0.4242	0.3919		0.4300	0.3939		0.4259	0.3853
7B1	0.4221	0.3984	7B2	0.4259	0.4073	7B3	0.4322	0.4096	7B4	0.4281	0.4006
	0.4259	0.4073		0.4299	0.4165		0.4364	0.4188		0.4322	0.4096
	0.4322	0.4096		0.4364	0.4188		0.4430	0.4212		0.4385	0.4119
	0.4281	0.4006		0.4322	0.4096		0.4385	0.4119		0.4342	0.4028
7C1	0.4342	0.4028	7C2	0.4385	0.4119	7C3	0.4449	0.4141	7C4	0.4403	0.4049
	0.4385	0.4119		0.4430	0.4212		0.4496	0.4236		0.4449	0.4141
	0.4449	0.4141		0.4496	0.4236		0.4562	0.4260		0.4513	0.4164
	0.4403	0.4049		0.4449	0.4141		0.4513	0.4164		0.4465	0.4071
7D1	0.4259	0.3853	7D2	0.4300	0.3939	7D3	0.4359	0.3960	7D4	0.4316	0.3873
	0.4300	0.3939		0.4342	0.4028		0.4403	0.4049		0.4359	0.3960
	0.4359	0.3960		0.4403	0.4049		0.4465	0.4071		0.4418	0.3981
	0.4316	0.3873		0.4359	0.3960		0.4418	0.3981		0.4373	0.3893
8A1	0.4373	0.3893	8A2	0.4418	0.3981	8A3	0.4475	0.3994	8A4	0.4428	0.3906
	0.4418	0.3981		0.4465	0.4071		0.4523	0.4085		0.4475	0.3994
	0.4475	0.3994		0.4523	0.4085		0.4582	0.4099		0.4532	0.4008
	0.4428	0.3906		0.4475	0.3994		0.4532	0.4008		0.4483	0.3919
8B1	0.4465	0.4071	8B2	0.4513	0.4164	8B3	0.4573	0.4178	8B4	0.4523	0.4085
	0.4513	0.4164		0.4562	0.4260		0.4624	0.4274		0.4573	0.4178
	0.4573	0.4178		0.4624	0.4274		0.4687	0.4289		0.4634	0.4193
	0.4523	0.4085		0.4573	0.4178		0.4634	0.4193		0.4582	0.4099
8C1	0.4582	0.4099	8C2	0.4634	0.4193	8C3	0.4695	0.4207	8C4	0.4641	0.4112
	0.4634	0.4193		0.4687	0.4289		0.4750	0.4304		0.4695	0.4207
	0.4695	0.4207		0.4750	0.4304		0.4813	0.4319		0.4756	0.4221
	0.4641	0.4112		0.4695	0.4207		0.4756	0.4221		0.4700	0.4126
8D1	0.4483	0.3919	8D2	0.4532	0.4008	8D3	0.4589	0.4021	8D4	0.4538	0.3931
	0.4532	0.4008		0.4582	0.4099		0.4641	0.4112		0.4589	0.4021
	0.4589	0.4021		0.4641	0.4112		0.4700	0.4126		0.4646	0.4034
	0.4538	0.3931		0.4589	0.4021		0.4646	0.4034		0.4593	0.3944

**CREE'S STANDARD CHROMATICITY REGIONS PLOTTED ON THE 1931 CIE CURVE**

ANSI Cool White

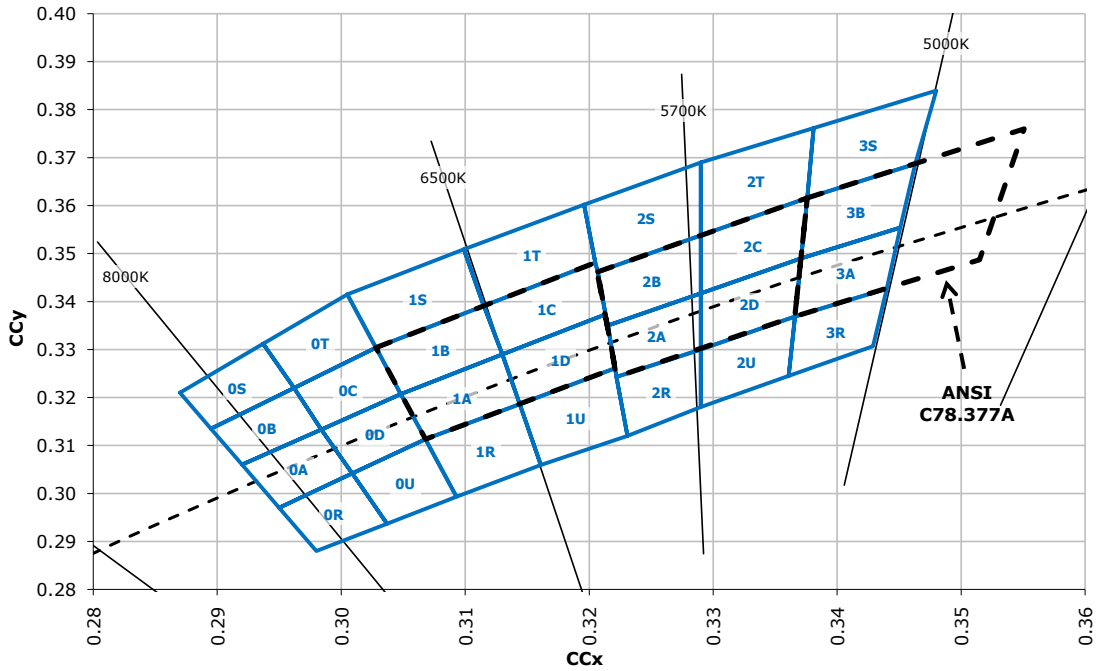

ANSI Neutral White and ANSI Warm White

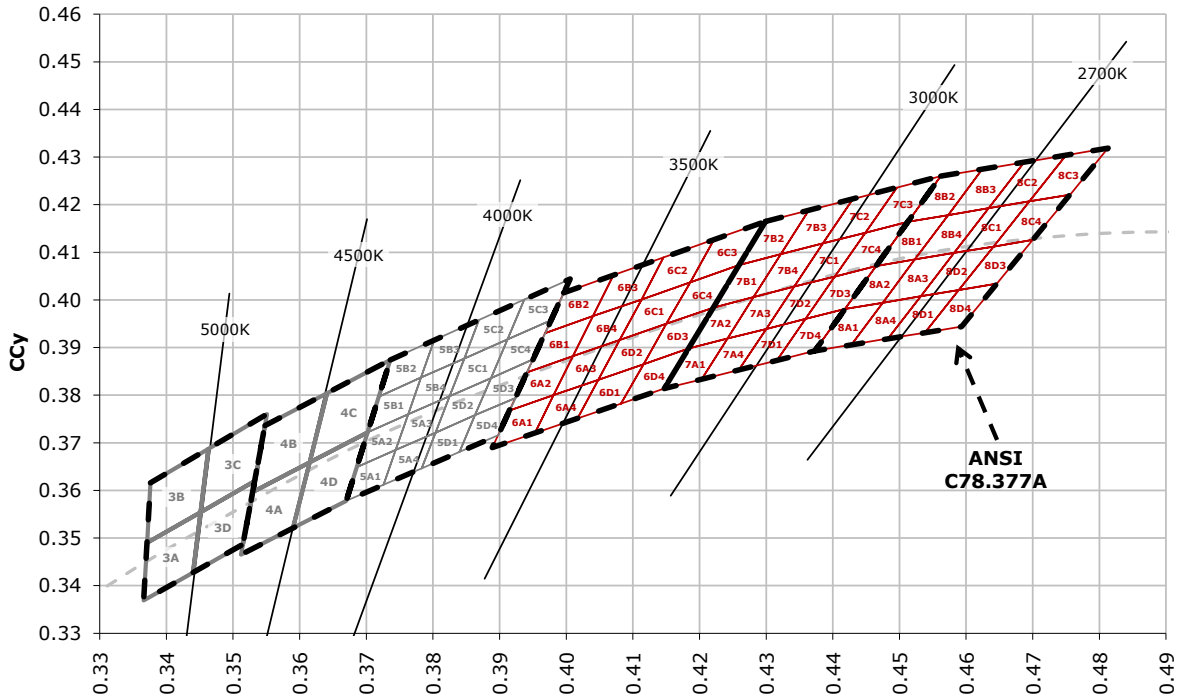

Outdoor White

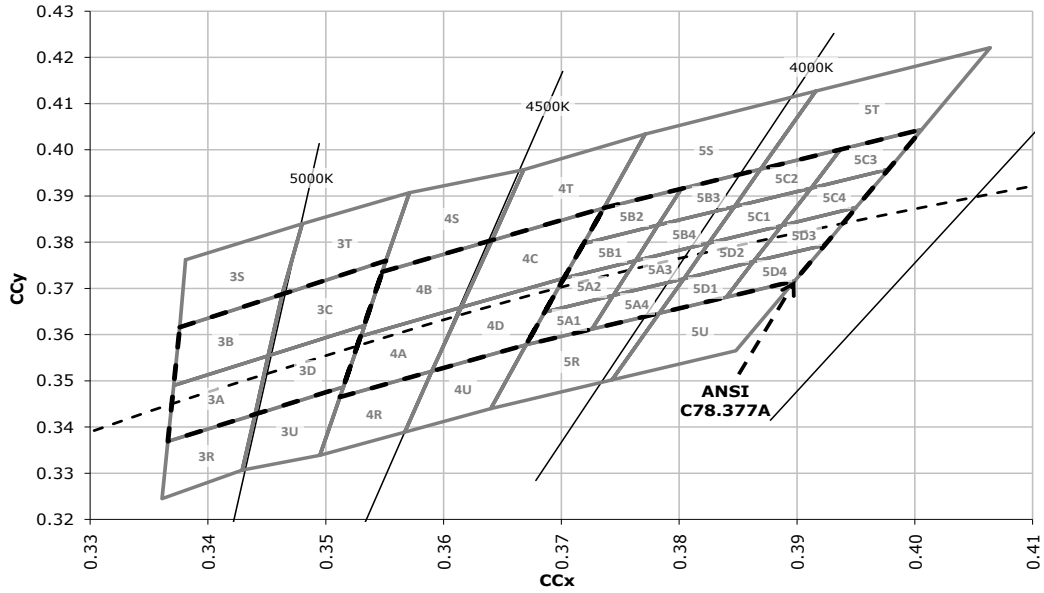

CREE'S STANDARD COOL WHITE KITS PLOTTED ON ANSI STANDARD CHROMATICITY REGIONS

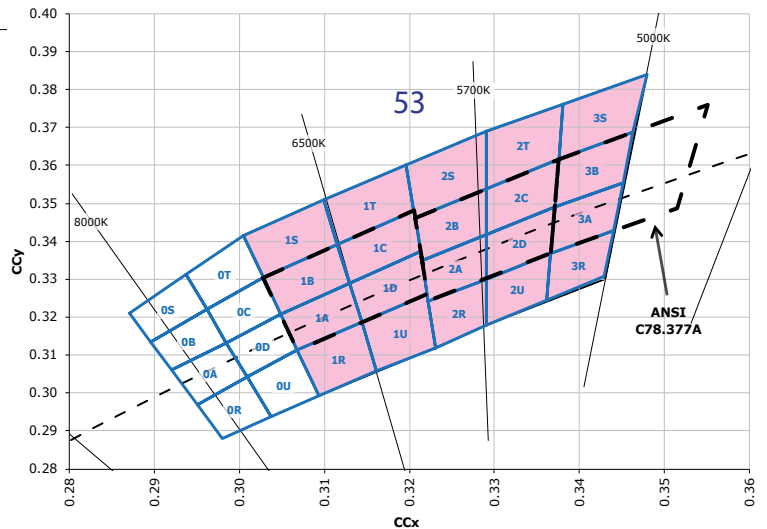
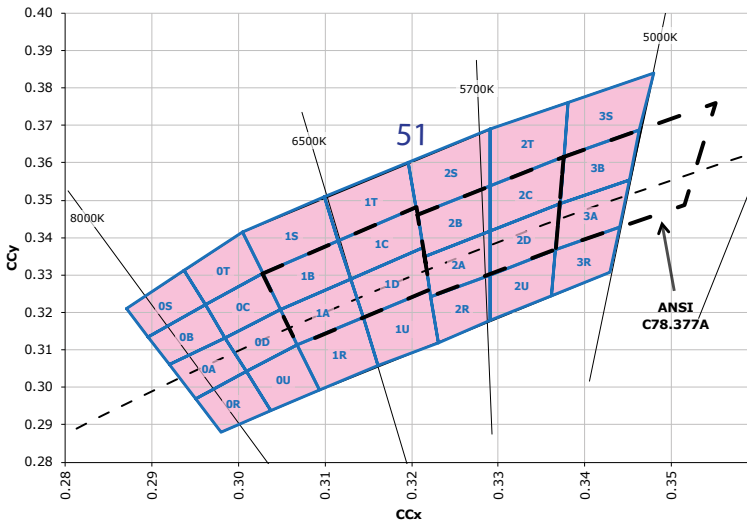

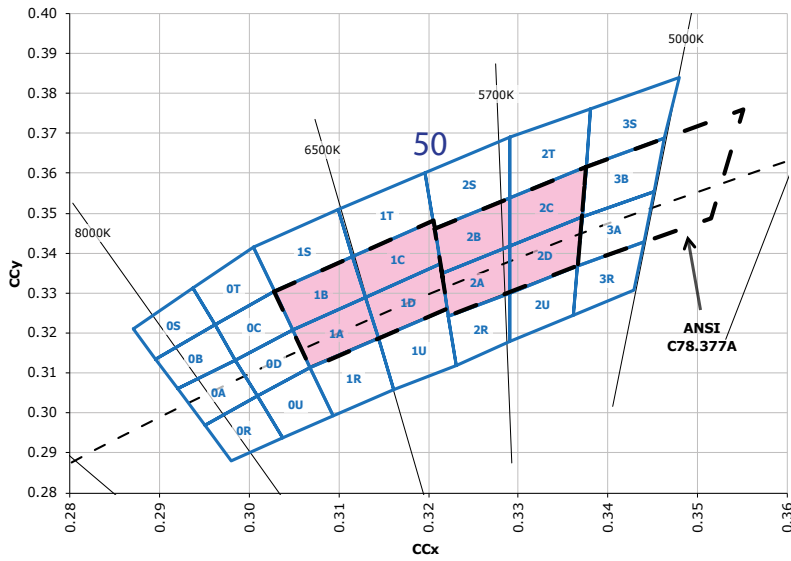

**CREE'S OUTDOOR WHITE KITS PLOTTED ON ANSI STANDARD CHROMATICITY REGIONS**

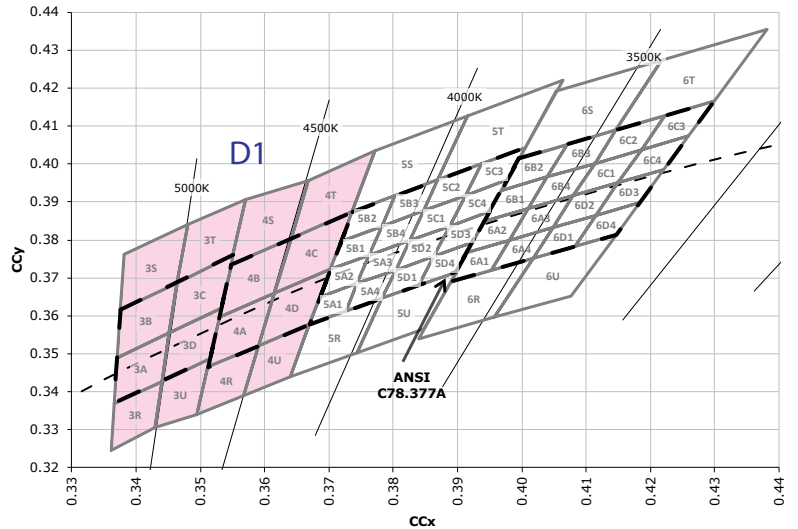
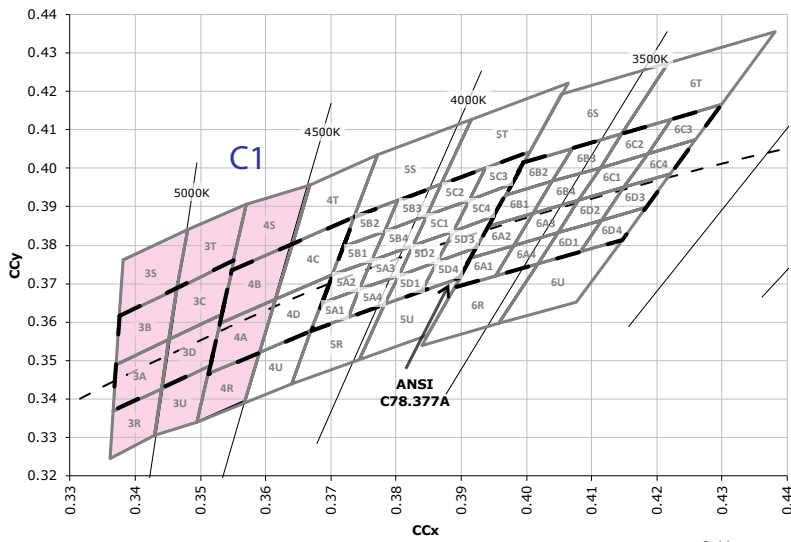



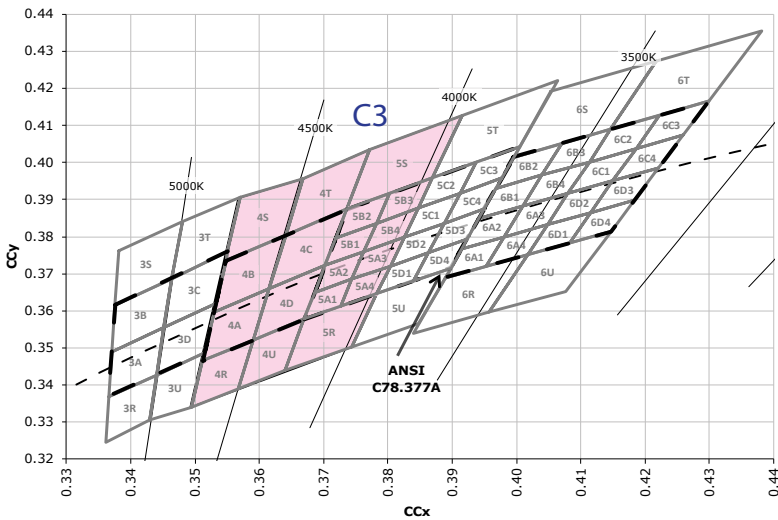
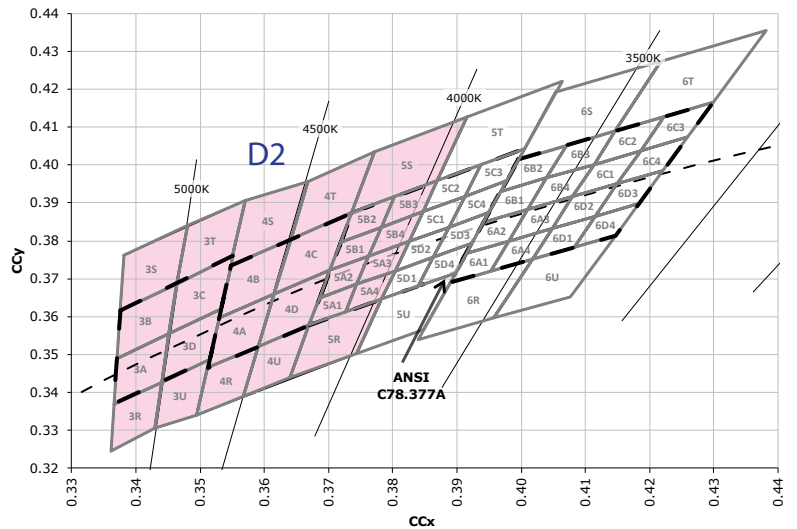
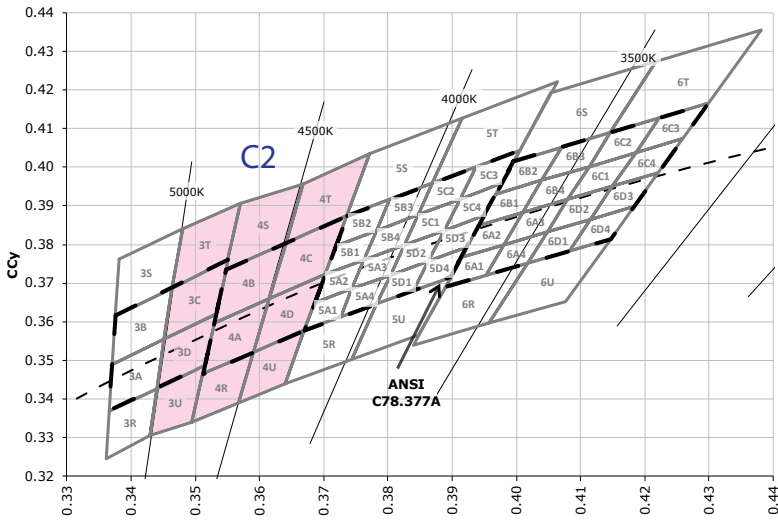

**CREE'S STANDARD WARM AND NEUTRAL WHITE KITS PLOTTED ON ANSI STANDARD CHROMATICITY REGIONS**

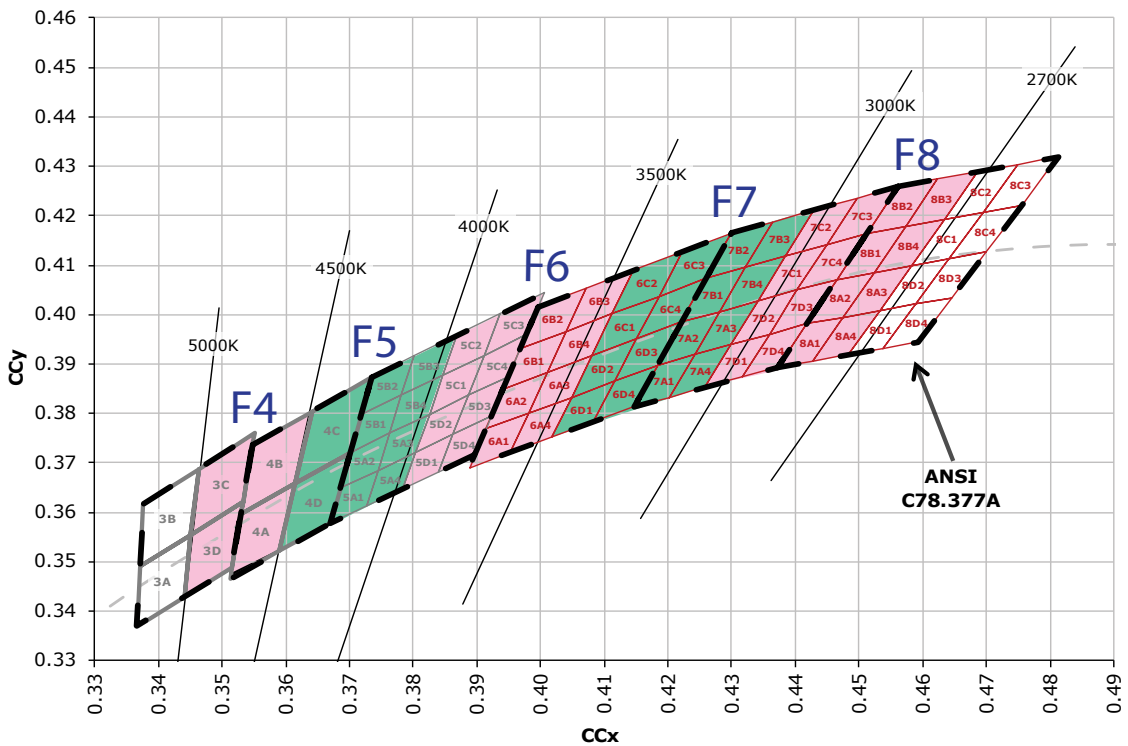
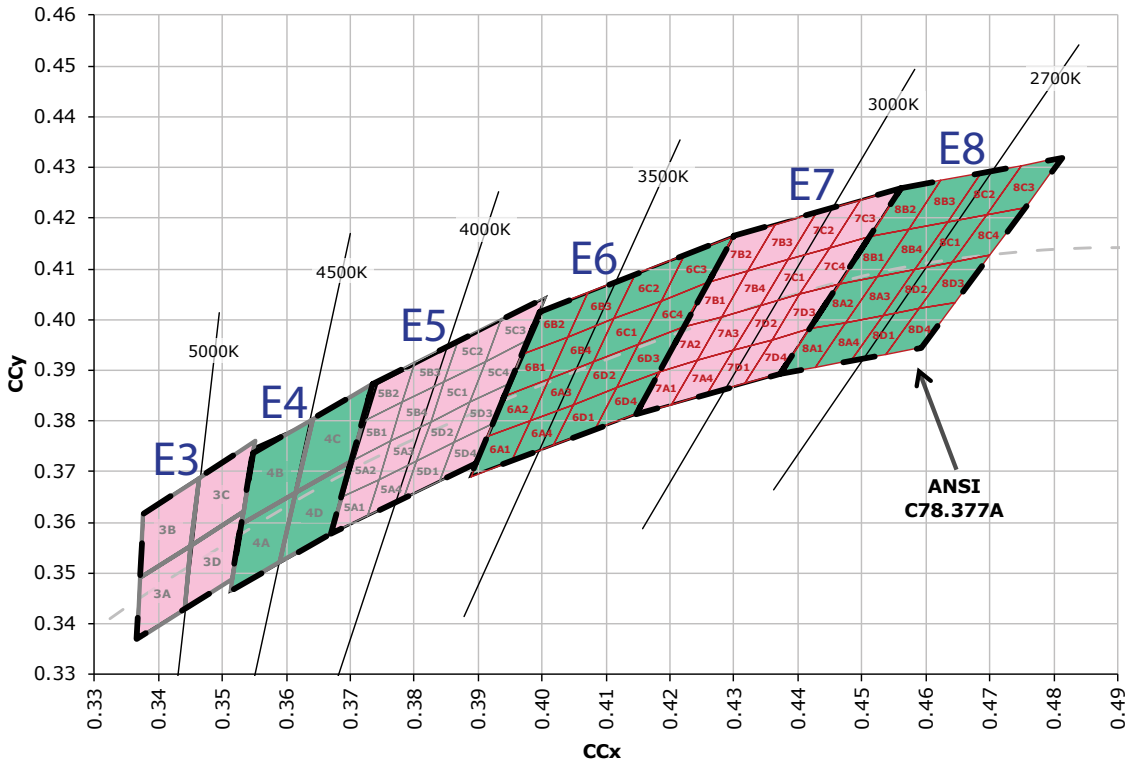

**CREE'S STANDARD CHROMATICITY KITS**

The following table provides the chromaticity bins associated with chromaticity kits.

Color	Kit	Chromaticity Bins
Cool White	51	0A, 0B, 0C, 0D, 0R, 0S, 0T, 0U, 1A, 1B, 1C, 1D, 1R, 1S, 1T, 1U, 2A, 2B, 2C, 2D, 2R, 2S, 2T, 2U, 3A, 3B, 3R, 3S
	53	1A, 1B, 1C, 1D, 1R, 1S, 1T, 1U, 2A, 2B, 2C, 2D, 2R, 2S, 2T, 3A, 3B, 3S
	50	1A, 1B, 1C, 1D, 2A, 2B, 2C, 2D
Neutral White	E3	3A, 3B, 3C, 3D
	C1	3A, 3B, 3C, 3D, 3R, 3S, 3T, 3U, 4A, 4B, 4R, 4S
	F4	3C, 3D, 4A, 4B
	D1	3A, 3B, 3C, 3D, 3R, 3S, 3T, 3U, 4A, 4B, 4C, 4D, 4R, 4S, 4T, 4U
	E4	4A, 4B, 4C, 4D
	D2	3C, 3D, 3T, 3U, 4A, 4B, 4C, 4D, 4R, 4S, 4T, 4U, 5A1, 5A2, 5A3, 5A4, 5B1, 5B2, 5B3, 5B4, 5R, 5S
	C2	3C, 3D, 3T, 3U, 4A, 4B, 4C, 4D, 4R, 4S, 4T, 4U
	C3	4A, 4B, 4C, 4D, 4R, 4S, 4T, 4U, 5A1, 5A2, 5A3, 5A4, 5B1, 5B2, 5B3, 5B4, 5R, 5S
	F5	4C, 4D, 5A1, 5A2, 5A3, 5A4, 5B1, 5B2, 5B3, 5B4
	E5	5A1, 5A2, 5A3, 5A4, 5B1, 5B2, 5B3, 5B4, 5C1, 5C2, 5C3, 5C4, 5D1, 5D2, 5D3, 5D4
Warm White	F6	5C1, 5C2, 5C3, 5C4, 5D1, 5D2, 5D3, 5D4, 6A1, 6A2, 6A3, 6A4, 6B1, 6B2, 6B3, 6B4
	E6	6A1, 6A2, 6A3, 6A4, 6B1, 6B2, 6B3, 6B4, 6C1, 6C2, 6C3, 6C4, 6D1, 6D2, 6D3, 6D4
	F7	6C1, 6C2, 6C3, 6C4, 6D1, 6D2, 6D3, 6D4, 7A1, 7A2, 7A3, 7A4, 7B1, 7B2, 7B3, 7B4
	E7	7A1, 7A2, 7A3, 7A4, 7B1, 7B2, 7B3, 7B4, 7C1, 7C2, 7C3, 7C4, 7D1, 7D2, 7D3, 7D4
	F8	7C1, 7C2, 7C3, 7C4, 7D1, 7D2, 7D3, 7D4, 8A1, 8A2, 8A3, 8A4, 8B1, 8B2, 8B3, 8B4
	E8	8A1, 8A2, 8A3, 8A4, 8B1, 8B2, 8B3, 8B4, 8C1, 8C2, 8C3, 8C4, 8D1, 8D2, 8D3, 8D4

The following tables of order codes list flux minimums and chromaticity regions for the various categories of XLamp XB-D LEDs. For other flux and chromaticity combinations, contact Cree or an authorized distributor.

**STANDARD ORDER CODES AND BINS (XB-D ANSI COOL WHITE, T<sub>j</sub> = 85 °C)**

XLamp XB-D Standard Kit Codes - White					
Chromaticity		Minimum Luminous Flux (lm) @ 350 mA*		Order Codes	
Kit	CCT	Code	Flux (lm)	No Minimum CRI	70 CRI Minimum
ANSI Cool White (5000 K – 8300 K)					
51	6200 K	R4	130	XBDAWT-00-0000-000000G51	XBDAWT-00-0000-00000BG51
		R3	122	XBDAWT-00-0000-000000F51	XBDAWT-00-0000-00000BF51
		R2	114	XBDAWT-00-0000-000000E51	XBDAWT-00-0000-00000BE51
53	6000 K	R4	130	XBDAWT-00-0000-000000G53	XBDAWT-00-0000-00000BG53
		R3	122	XBDAWT-00-0000-000000F53	XBDAWT-00-0000-00000BF53
		R2	114	XBDAWT-00-0000-000000E53	XBDAWT-00-0000-00000BE53
50	6200 K	R4	130	XBDAWT-00-0000-000000G50	XBDAWT-00-0000-00000BG50
		R3	122	XBDAWT-00-0000-000000F50	XBDAWT-00-0000-00000BF50
		R2	114	XBDAWT-00-0000-000000E50	XBDAWT-00-0000-00000BE50

**STANDARD ORDER CODES AND BINS (XB-D NEUTRAL WHITE, T<sub>j</sub> = 85 °C)**

XLamp XB-D Standard Kit Codes - White				
Chromaticity		Minimum Luminous Flux (lm) @ 350 mA*		Order Codes
Kit	CCT	Code	Flux (lm)	Standard CRI
ANSI Neutral White (3700 K – 5000 K)				
E3	5000 K	R3	122	XBDAWT-00-0000-00000LFE3
		R2	114	XBDAWT-00-0000-00000LEE3
		Q5	107	XBDAWT-00-0000-00000LDE3
C1	5000 K	R3	122	XBDAWT-00-0000-00000LFC1
		R2	114	XBDAWT-00-0000-00000LEC1
		Q5	107	XBDAWT-00-0000-00000LDC1
F4	4750 K	R2	114	XBDAWT-00-0000-00000LEF4
		Q5	107	XBDAWT-00-0000-00000LDF4
		Q4	100	XBDAWT-00-0000-00000LCF4
D1	4750 K	R3	122	XBDAWT-00-0000-00000LFD1
		R2	114	XBDAWT-00-0000-00000LED1
		Q5	107	XBDAWT-00-0000-00000LDD1
E4	4500 K	R2	114	XBDAWT-00-0000-00000LEE4
		Q5	107	XBDAWT-00-0000-00000LDE4
		Q4	100	XBDAWT-00-0000-00000LCE4
D2	4500 K	R2	114	XBDAWT-00-0000-00000LED2
		Q5	107	XBDAWT-00-0000-00000LDD2
		Q4	100	XBDAWT-00-0000-00000LCD2
C2	4500 K	R3	122	XBDAWT-00-0000-00000LFC2
		R2	114	XBDAWT-00-0000-00000LEC2
		Q5	107	XBDAWT-00-0000-00000LDC2
C3	4300 K	R3	122	XBDAWT-00-0000-00000LFC3
		R2	114	XBDAWT-00-0000-00000LEC3
		Q5	107	XBDAWT-00-0000-00000LDC3
F5	4250 K	Q5	107	XBDAWT-00-0000-00000LDF5
		Q4	100	XBDAWT-00-0000-00000LCF5
		Q3	93.9	XBDAWT-00-0000-00000LBF5
E5	4000 K	Q5	107	XBDAWT-00-0000-00000LDE5
		Q4	100	XBDAWT-00-0000-00000LCE5
		Q3	93.9	XBDAWT-00-0000-00000LBE5

**STANDARD ORDER CODES AND BINS (XB-D WARM WHITE,  $T_j = 85\text{ }^\circ\text{C}$ )**

XLamp XB-D Standard Kit Codes - White					
Chromaticity		Minimum Luminous Flux (lm) @ 350 mA*		Order Codes	
Kit	CCT	Code	Flux (lm)	Standard CRI	80 CRI Minimum
ANSI Warm White (2700 K - 3750 K)					
F6	3750 K	Q5	107	XBDAWT-00-0000-00000LDF6	XBDAWT-00-0000-00000HDF6
		Q4	100	XBDAWT-00-0000-00000LCF6	XBDAWT-00-0000-00000HCF6
		Q3	93.9	XBDAWT-00-0000-00000LBF6	XBDAWT-00-0000-00000HBF6
E6	3500 K	Q5	107	XBDAWT-00-0000-00000LDE6	XBDAWT-00-0000-00000HDE6
		Q4	100	XBDAWT-00-0000-00000LCE6	XBDAWT-00-0000-00000HCE6
		Q3	93.9	XBDAWT-00-0000-00000LBE6	XBDAWT-00-0000-00000HBE6
F7	3250 K	Q4	100	XBDAWT-00-0000-00000LCF7	XBDAWT-00-0000-00000HCF7
		Q3	93.9	XBDAWT-00-0000-00000LBF7	XBDAWT-00-0000-00000HBF7
		Q2	87.4	XBDAWT-00-0000-00000LAF7	XBDAWT-00-0000-00000HAF7
E7	3000 K	Q4	100	XBDAWT-00-0000-00000LCE7	XBDAWT-00-0000-00000HCE7
		Q3	93.9	XBDAWT-00-0000-00000LBE7	XBDAWT-00-0000-00000HBE7
		Q2	87.4	XBDAWT-00-0000-00000LAE7	XBDAWT-00-0000-00000HAE7
F8	2850 K	Q3	93.9	XBDAWT-00-0000-00000LBF8	XBDAWT-00-0000-00000HBF8
		Q2	87.4	XBDAWT-00-0000-00000LAF8	XBDAWT-00-0000-00000HAF8
		P4	80.6	XBDAWT-00-0000-00000L9F8	XBDAWT-00-0000-00000H9F8
E8	2700 K	Q3	93.9	XBDAWT-00-0000-00000LBE8	XBDAWT-00-0000-00000HBE8
		Q2	87.4	XBDAWT-00-0000-00000LAE8	XBDAWT-00-0000-00000HAE8
		P4	80.6	XBDAWT-00-0000-00000L9E8	XBDAWT-00-0000-00000H9E8

- Typical CRI for Warm White, 2600 K - 3700 K CCT is 80.
- Typical CRI for Neutral White, 3700 K - 5000K CCT is 75.

\* Cree XLamp XB Family order codes specify only a minimum flux bin and not a maximum. Cree may ship reels in flux bins higher than the minimum specified by the order code