

FEATURES

- **Ultralow Quiescent Current: $3\mu\text{A}$**
- **Input Voltage Range: 2.0V to 45V**
- **Output Current: 20mA**
- **Dropout Voltage: 300mV**
- **Adjustable Output ($V_{ADJ} = V_{OUT(MIN)} = 600\text{mV}$)**
- **Fixed Output Voltages: 1.2V, 1.5V, 1.8V, 2.5V, 3.3V, 5V**
- **Output Tolerance: $\pm 2\%$ Over Load, Line and Temperature**
- **Stable with Low ESR, Ceramic Output Capacitors (2.2 μF Minimum)**
- **Shutdown Current: $< 1\mu\text{A}$**
- **Current Limit Protection**
- **Reverse-Battery Protection**
- **Thermal Limit Protection**
- **TSOT-23 and 2mm \times 2mm DFN Packages**

APPLICATIONS

- Automotive
- Low Current Battery-Powered Systems
- Keep-Alive Power Supplies
- Remote Monitoring
- Utility Meters
- Low Power Industrial Applications

DESCRIPTION

The LT[®]3008 series are micropower, low dropout voltage (LDO) linear regulators. The devices supply 20mA output current with a dropout voltage of 300mV. No-load quiescent current is $3\mu\text{A}$. Ground pin current remains at less than 5% of output current as load increases. In shutdown, quiescent current is less than $1\mu\text{A}$.

The LT3008 regulators optimize stability and transient response with low ESR ceramic capacitors, requiring a minimum of only 2.2 μF . The regulators do not require the addition of ESR as is common with other regulators. Internal protection circuitry includes current limiting, thermal limiting, reverse-battery protection and reverse-current protection.

The LT3008 series are ideal for applications that require moderate output drive capability coupled with ultralow standby power consumption. The device is available in fixed output voltages of 1.2V, 1.5V, 1.8V, 2.5V, 3.3V and 5V, and an adjustable version with an output voltage range of 0.6V to 44.5V. The LT3008 is available in the thermally enhanced 6-lead DFN and 8-lead TSOT-23 packages.

LT, LT, LTC, LTM, Linear Technology and the Linear logo are registered trademarks of Linear Technology Corporation. All other trademarks are the property of their respective owners.

TYPICAL APPLICATION

3.3V, 20mA Supply with Shutdown

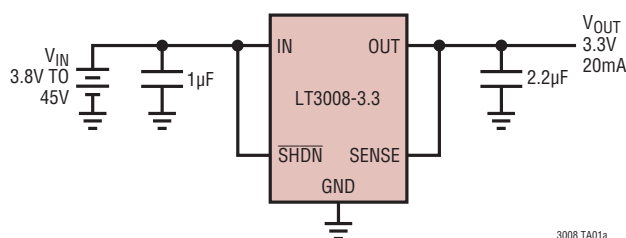

Dropout Voltage/Quiescent Current

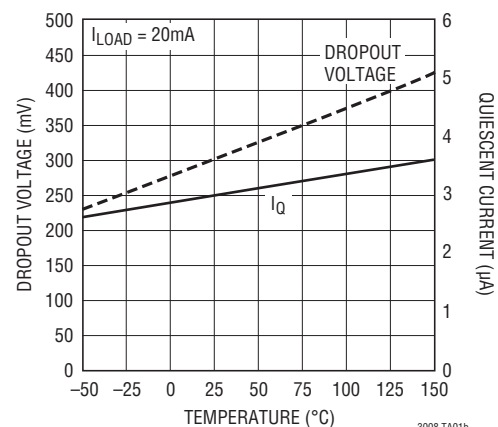

LT3008 Series

ABSOLUTE MAXIMUM RATINGS (Note 1)

IN Pin Voltage	±50V	Operating Junction Temperature Range (Notes 2, 3)	
OUT Pin Voltage	±50V	E, I Grade	–40°C to 125°C
Input-to-Output Differential Voltage	±50V	MP Grade	–55°C to 125°C
ADJ Pin Voltage	±50V	Storage Temperature Range	–65°C to 150°C
SENSE Pin Voltage	±50V	Lead Temperature: Soldering, 10 sec	
SHDN Pin Voltage (Note 8)	±50V	TS8 Package Only	300°C
Output Short-Circuit Duration	Indefinite		

PIN CONFIGURATION

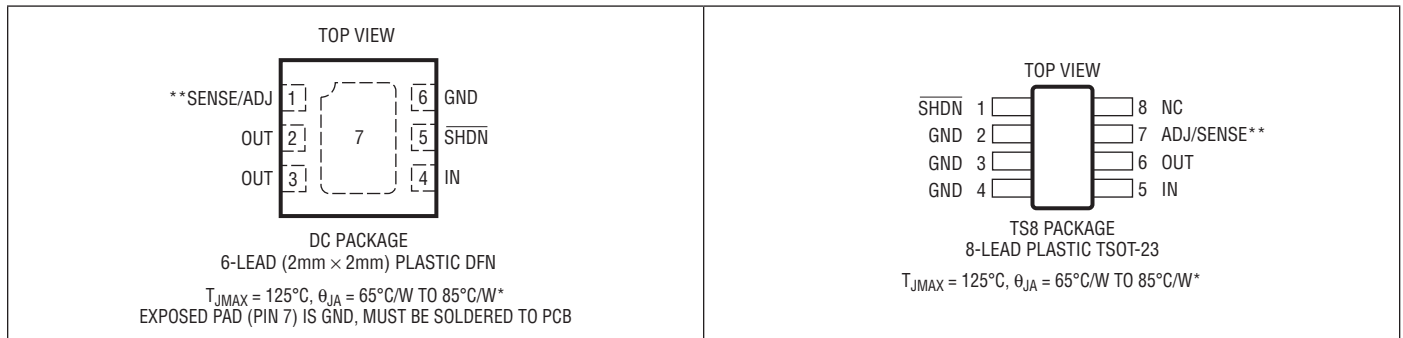

* See the Applications Information Section.

** SENSE for Fixed Voltage Output Versions.

ORDER INFORMATION

LEAD FREE FINISH	TAPE AND REEL	PART MARKING*	PACKAGE DESCRIPTION	TEMPERATURE RANGE
LT3008EDC#PBF	LT3008EDC#TRPBF	LDPS	6-Lead (2mm × 2mm) Plastic DFN	–40°C to 125°C
LT3008IDC#PBF	LT3008IDC#TRPBF	LDPS	6-Lead (2mm × 2mm) Plastic DFN	–40°C to 125°C
LT3008EDC-1.2#PBF	LT3008EDC-1.2#TRPBF	LFHC	6-Lead (2mm × 2mm) Plastic DFN	–40°C to 125°C
LT3008IDC-1.2#PBF	LT3008IDC-1.2#TRPBF	LFHC	6-Lead (2mm × 2mm) Plastic DFN	–40°C to 125°C
LT3008EDC-1.5#PBF	LT3008EDC-1.5#TRPBF	LFHF	6-Lead (2mm × 2mm) Plastic DFN	–40°C to 125°C
LT3008IDC-1.5#PBF	LT3008IDC-1.5#TRPBF	LFHF	6-Lead (2mm × 2mm) Plastic DFN	–40°C to 125°C
LT3008EDC-1.8#PBF	LT3008EDC-1.8#TRPBF	LFHH	6-Lead (2mm × 2mm) Plastic DFN	–40°C to 125°C
LT3008IDC-1.8#PBF	LT3008IDC-1.8#TRPBF	LFHH	6-Lead (2mm × 2mm) Plastic DFN	–40°C to 125°C
LT3008EDC-2.5#PBF	LT3008EDC-2.5#TRPBF	LFHK	6-Lead (2mm × 2mm) Plastic DFN	–40°C to 125°C
LT3008IDC-2.5#PBF	LT3008IDC-2.5#TRPBF	LFHK	6-Lead (2mm × 2mm) Plastic DFN	–40°C to 125°C
LT3008EDC-3.3#PBF	LT3008EDC-3.3#TRPBF	LFHN	6-Lead (2mm × 2mm) Plastic DFN	–40°C to 125°C
LT3008IDC-3.3#PBF	LT3008IDC-3.3#TRPBF	LFHN	6-Lead (2mm × 2mm) Plastic DFN	–40°C to 125°C
LT3008EDC-5#PBF	LT3008EDC-5#TRPBF	LFHQ	6-Lead (2mm × 2mm) Plastic DFN	–40°C to 125°C
LT3008IDC-5#PBF	LT3008IDC-5#TRPBF	LFHQ	6-Lead (2mm × 2mm) Plastic DFN	–40°C to 125°C
LT3008ETS8#PBF	LT3008ETS8#TRPBF	LTDSX	8-Lead Plastic TSOT-23	–40°C to 125°C

3008fb

ORDER INFORMATION

LEAD FREE FINISH	TAPE AND REEL	PART MARKING*	PACKAGE DESCRIPTION	TEMPERATURE RANGE
LT3008ITS8#PBF	LT3008ITS8#TRPBF	LTDSX	8-Lead Plastic TSOT-23	-40°C to 125°C
LT3008MPTS8#PBF	LT3008MPTS8#TRPBF	LTDSX	8-Lead Plastic TSOT-23	-55°C to 125°C
LT3008ETS8-1.2#PBF	LT3008ETS8-1.2#TRPBF	LTFFHD	8-Lead Plastic TSOT-23	-40°C to 125°C
LT3008ITS8-1.2#PBF	LT3008ITS8-1.2#TRPBF	LTFFHD	8-Lead Plastic TSOT-23	-40°C to 125°C
LT3008MPTS8-1.2#PBF	LT3008MPTS8-1.2#TRPBF	LTFFHD	8-Lead Plastic TSOT-23	-55°C to 125°C
LT3008ETS8-1.5#PBF	LT3008ETS8-1.5#TRPBF	LTFFHG	8-Lead Plastic TSOT-23	-40°C to 125°C
LT3008ITS8-1.5#PBF	LT3008ITS8-1.5#TRPBF	LTFFHG	8-Lead Plastic TSOT-23	-40°C to 125°C
LT3008MPTS8-1.5#PBF	LT3008MPTS8-1.5#TRPBF	LTFFHG	8-Lead Plastic TSOT-23	-55°C to 125°C
LT3008ETS8-1.8#PBF	LT3008ETS8-1.8#TRPBF	LTFFHJ	8-Lead Plastic TSOT-23	-40°C to 125°C
LT3008ITS8-1.8#PBF	LT3008ITS8-1.8#TRPBF	LTFFHJ	8-Lead Plastic TSOT-23	-40°C to 125°C
LT3008MPTS8-1.8#PBF	LT3008MPTS8-1.8#TRPBF	LTFFHJ	8-Lead Plastic TSOT-23	-55°C to 125°C
LT3008ETS8-2.5#PBF	LT3008ETS8-2.5#TRPBF	LTFFHM	8-Lead Plastic TSOT-23	-40°C to 125°C
LT3008ITS8-2.5#PBF	LT3008ITS8-2.5#TRPBF	LTFFHM	8-Lead Plastic TSOT-23	-40°C to 125°C
LT3008MPTS8-2.5#PBF	LT3008MPTS8-2.5#TRPBF	LTFFHM	8-Lead Plastic TSOT-23	-55°C to 125°C
LT3008ETS8-3.3#PBF	LT3008ETS8-3.3#TRPBF	LTFFHP	8-Lead Plastic TSOT-23	-40°C to 125°C
LT3008ITS8-3.3#PBF	LT3008ITS8-3.3#TRPBF	LTFFHP	8-Lead Plastic TSOT-23	-40°C to 125°C
LT3008MPTS8-3.3#PBF	LT3008MPTS8-3.3#TRPBF	LTFFHP	8-Lead Plastic TSOT-23	-55°C to 125°C
LT3008ETS8-5#PBF	LT3008ETS8-5#TRPBF	LTFFHR	8-Lead Plastic TSOT-23	-40°C to 125°C
LT3008ITS8-5#PBF	LT3008ITS8-5#TRPBF	LTFFHR	8-Lead Plastic TSOT-23	-40°C to 125°C
LT3008MPTS8-5#PBF	LT3008MPTS8-5#TRPBF	LTFFHR	8-Lead Plastic TSOT-23	-55°C to 125°C
LEAD BASED FINISH	TAPE AND REEL	PART MARKING*	PACKAGE DESCRIPTION	TEMPERATURE RANGE
LT3008EDC	LT3008EDC#TR	LDPS	6-Lead (2mm × 2mm) Plastic DFN	-40°C to 125°C
LT3008IDC	LT3008IDC#TR	LDPS	6-Lead (2mm × 2mm) Plastic DFN	-40°C to 125°C
LT3008EDC-1.2	LT3008EDC-1.2#TR	LFHC	6-Lead (2mm × 2mm) Plastic DFN	-40°C to 125°C
LT3008IDC-1.2	LT3008IDC-1.2#TR	LFHC	6-Lead (2mm × 2mm) Plastic DFN	-40°C to 125°C
LT3008EDC-1.5	LT3008EDC-1.5#TR	LFHF	6-Lead (2mm × 2mm) Plastic DFN	-40°C to 125°C
LT3008IDC-1.5	LT3008IDC-1.5#TR	LFHF	6-Lead (2mm × 2mm) Plastic DFN	-40°C to 125°C
LT3008EDC-1.8	LT3008EDC-1.8#TR	LFHH	6-Lead (2mm × 2mm) Plastic DFN	-40°C to 125°C
LT3008IDC-1.8	LT3008IDC-1.8#TR	LFHH	6-Lead (2mm × 2mm) Plastic DFN	-40°C to 125°C
LT3008EDC-2.5	LT3008EDC-2.5#TR	LFHK	6-Lead (2mm × 2mm) Plastic DFN	-40°C to 125°C
LT3008IDC-2.5	LT3008IDC-2.5#TR	LFHK	6-Lead (2mm × 2mm) Plastic DFN	-40°C to 125°C
LT3008EDC-3.3	LT3008EDC-3.3#TR	LFHN	6-Lead (2mm × 2mm) Plastic DFN	-40°C to 125°C
LT3008IDC-3.3	LT3008IDC-3.3#TR	LFHN	6-Lead (2mm × 2mm) Plastic DFN	-40°C to 125°C
LT3008EDC-5	LT3008EDC-5#TR	LFHQ	6-Lead (2mm × 2mm) Plastic DFN	-40°C to 125°C
LT3008IDC-5	LT3008IDC-5#TR	LFHQ	6-Lead (2mm × 2mm) Plastic DFN	-40°C to 125°C
LT3008ETS8	LT3008ETS8#TR	LTDSX	8-Lead Plastic TSOT-23	-40°C to 125°C
LT3008ITS8	LT3008ITS8#TR	LTDSX	8-Lead Plastic TSOT-23	-40°C to 125°C
LT3008MPTS8	LT3008MPTS8#TR	LTDSX	8-Lead Plastic TSOT-23	-55°C to 125°C
LT3008ETS8-1.2	LT3008ETS8-1.2#TR	LTFFHD	8-Lead Plastic TSOT-23	-40°C to 125°C
LT3008ITS8-1.2	LT3008ITS8-1.2#TR	LTFFHD	8-Lead Plastic TSOT-23	-40°C to 125°C
LT3008MPTS8-1.2	LT3008MPTS8-1.2#TR	LTFFHD	8-Lead Plastic TSOT-23	-55°C to 125°C

LT3008 Series

ORDER INFORMATION

LEAD BASED FINISH	TAPE AND REEL	PART MARKING*	PACKAGE DESCRIPTION	TEMPERATURE RANGE
LT3008ETS8-1.5	LT3008ETS8-1.5#TR	LTFHG	8-Lead Plastic TSOT-23	-40°C to 125°C
LT3008ITS8-1.5	LT3008ITS8-1.5#TR	LTFHG	8-Lead Plastic TSOT-23	-40°C to 125°C
LT3008MPTS8-1.5	LT3008MPTS8-1.5#TR	LTFHG	8-Lead Plastic TSOT-23	-55°C to 125°C
LT3008ETS8-1.8	LT3008ETS8-1.8#TR	LTFHJ	8-Lead Plastic TSOT-23	-40°C to 125°C
LT3008ITS8-1.8	LT3008ITS8-1.8#TR	LTFHJ	8-Lead Plastic TSOT-23	-40°C to 125°C
LT3008MPTS8-1.8	LT3008MPTS8-1.8#TR	LTFHJ	8-Lead Plastic TSOT-23	-55°C to 125°C
LT3008ETS8-2.5	LT3008ETS8-2.5#TR	LTFHM	8-Lead Plastic TSOT-23	-40°C to 125°C
LT3008ITS8-2.5	LT3008ITS8-2.5#TR	LTFHM	8-Lead Plastic TSOT-23	-40°C to 125°C
LT3008MPTS8-2.5	LT3008MPTS8-2.5#TR	LTFHM	8-Lead Plastic TSOT-23	-55°C to 125°C
LT3008ETS8-3.3	LT3008ETS8-3.3#TR	LTFHP	8-Lead Plastic TSOT-23	-40°C to 125°C
LT3008ITS8-3.3	LT3008ITS8-3.3#TR	LTFHP	8-Lead Plastic TSOT-23	-40°C to 125°C
LT3008MPTS8-3.3	LT3008MPTS8-3.3#TR	LTFHP	8-Lead Plastic TSOT-23	-55°C to 125°C
LT3008ETS8-5	LT3008ETS8-5#TR	LTFHR	8-Lead Plastic TSOT-23	-40°C to 125°C
LT3008ITS8-5	LT3008ITS8-5#TR	LTFHR	8-Lead Plastic TSOT-23	-40°C to 125°C
LT3008MPTS8-5	LT3008MPTS8-5#TR	LTFHR	8-Lead Plastic TSOT-23	-55°C to 125°C

Consult LTC Marketing for parts specified with wider operating temperature ranges. *The temperature grade is identified by a label on the shipping container.

For more information on lead free part marking, go to: <http://www.linear.com/leadfree/>

For more information on tape and reel specifications, go to: <http://www.linear.com/tapeandreeel/>

ELECTRICAL CHARACTERISTICS

The ● denotes the specifications which apply over the full operating temperature range, otherwise specifications are at $T_J = 25^\circ\text{C}$. (Note 2)

PARAMETER	CONDITIONS	MIN	TYP	MAX	UNITS
Operating Voltage		● 2		45	V
Regulated Output Voltage	LT3008-1.2: $V_{IN} = 2V$, $I_{LOAD} = 100\mu\text{A}$	● 1.188	1.2	1.212	V
	$2V < V_{IN} < 45V$, $1\mu\text{A} < I_{LOAD} < 20\text{mA}$	● 1.176	1.2	1.224	V
	LT3008-1.5: $V_{IN} = 2.05V$, $I_{LOAD} = 100\mu\text{A}$	● 1.485	1.5	1.515	V
	$2.05V < V_{IN} < 45V$, $1\mu\text{A} < I_{LOAD} < 20\text{mA}$	● 1.47	1.5	1.53	V
	LT3008-1.8: $V_{IN} = 2.35V$, $I_{LOAD} = 100\mu\text{A}$	● 1.782	1.8	1.818	V
	$2.35V < V_{IN} < 45V$, $1\mu\text{A} < I_{LOAD} < 20\text{mA}$	● 1.764	1.8	1.836	V
	LT3008-2.5: $V_{IN} = 3.05V$, $I_{LOAD} = 100\mu\text{A}$	● 2.475	2.5	2.525	V
$3.05V < V_{IN} < 45V$, $1\mu\text{A} < I_{LOAD} < 20\text{mA}$	● 2.45	2.5	2.55	V	
ADJ Pin Voltage (Notes 3, 4)	LT3008-3.3: $V_{IN} = 3.85V$, $I_{LOAD} = 100\mu\text{A}$	● 3.267	3.3	3.333	V
	$3.85V < V_{IN} < 45V$, $1\mu\text{A} < I_{LOAD} < 20\text{mA}$	● 3.234	3.3	3.366	V
Line Regulation (Note 3)	LT3008-5: $V_{IN} = 5.55V$, $I_{LOAD} = 100\mu\text{A}$	● 4.95	5	5.05	V
	$5.55V < V_{IN} < 45V$, $1\mu\text{A} < I_{LOAD} < 20\text{mA}$	● 4.9	5	5.1	V
ADJ Pin Voltage (Notes 3, 4)	$V_{IN} = 2V$, $I_{LOAD} = 100\mu\text{A}$	● 594	600	606	mV
	$2V < V_{IN} < 45V$, $1\mu\text{A} < I_{LOAD} < 20\text{mA}$	● 588	600	612	mV
Line Regulation (Note 3)	LT3008-1.2: $\Delta V_{IN} = 2V$ to $45V$, $I_{LOAD} = 1\text{mA}$	●	1.2	6	mV
	LT3008-1.5: $\Delta V_{IN} = 2.05V$ to $45V$, $I_{LOAD} = 1\text{mA}$	●	1.5	7.5	mV
	LT3008-1.8: $\Delta V_{IN} = 2.35V$ to $45V$, $I_{LOAD} = 1\text{mA}$	●	1.8	9	mV
	LT3008-2.5: $\Delta V_{IN} = 3.05V$ to $45V$, $I_{LOAD} = 1\text{mA}$	●	2.5	12.5	mV
	LT3008-3.3: $\Delta V_{IN} = 3.85V$ to $45V$, $I_{LOAD} = 1\text{mA}$	●	3.3	16.5	mV
	LT3008-5: $\Delta V_{IN} = 5.55V$ to $45V$, $I_{LOAD} = 1\text{mA}$	●	5	25	mV
	LT3008: $\Delta V_{IN} = 2V$ to $45V$, $I_{LOAD} = 1\text{mA}$	●	0.6	3	mV

3008fb

ELECTRICAL CHARACTERISTICS

The ● denotes the specifications which apply over the full operating temperature range, otherwise specifications are at $T_J = 25^\circ\text{C}$. (Note 2)

PARAMETER	CONDITIONS	MIN	TYP	MAX	UNITS
Load Regulation (Note 3)	LT3008-1.2: $V_{IN} = 2\text{V}$, $I_{LOAD} = 1\mu\text{A}$ to 10mA	●	0.8	4	mV
	$V_{IN} = 2\text{V}$, $I_{LOAD} = 1\mu\text{A}$ to 20mA	●	1	10	mV
	LT3008-1.5: $V_{IN} = 2.05\text{V}$, $I_{LOAD} = 1\mu\text{A}$ to 10mA	●	1	5	mV
	$V_{IN} = 2.05\text{V}$, $I_{LOAD} = 1\mu\text{A}$ to 20mA	●	1.3	13	mV
	LT3008-1.8: $V_{IN} = 2.35\text{V}$, $I_{LOAD} = 1\mu\text{A}$ to 10mA	●	1.2	6	mV
	$V_{IN} = 2.35\text{V}$, $I_{LOAD} = 1\mu\text{A}$ to 20mA	●	1.5	15	mV
	LT3008-2.5: $V_{IN} = 3.05\text{V}$, $I_{LOAD} = 1\mu\text{A}$ to 10mA	●	1.7	8.3	mV
	$V_{IN} = 3.05\text{V}$, $I_{LOAD} = 1\mu\text{A}$ to 20mA	●	2.1	21	mV
Dropout Voltage $V_{IN} = V_{OUT(NOMINAL)}$ (Notes 5, 6)	$I_{LOAD} = 100\mu\text{A}$	●	115	180	mV
	$I_{LOAD} = 100\mu\text{A}$	●		250	mV
Dropout Voltage $V_{IN} = V_{OUT(NOMINAL)}$ (Notes 5, 6)	$I_{LOAD} = 1\text{mA}$	●	170	250	mV
	$I_{LOAD} = 1\text{mA}$	●		350	mV
	$I_{LOAD} = 10\text{mA}$	●	270	340	mV
	$I_{LOAD} = 10\text{mA}$	●		470	mV
Dropout Voltage $V_{IN} = V_{OUT(NOMINAL)}$ (Notes 5, 6)	$I_{LOAD} = 20\text{mA}$	●	300	365	mV
	$I_{LOAD} = 20\text{mA}$	●		500	mV
Quiescent Current (Notes 6, 7)	$I_{LOAD} = 0\mu\text{A}$	●	3		μA
	$I_{LOAD} = 0\mu\text{A}$	●		6	μA
GND Pin Current $V_{IN} = V_{OUT(NOMINAL)} + 0.5\text{V}$ (Notes 6, 7)	$I_{LOAD} = 0\mu\text{A}$	●	3	6	μA
	$I_{LOAD} = 100\mu\text{A}$	●	6	12	μA
	$I_{LOAD} = 1\text{mA}$	●	21	50	μA
	$I_{LOAD} = 10\text{mA}$	●	160	500	μA
	$I_{LOAD} = 20\text{mA}$	●	350	1200	μA
Output Voltage Noise (Note 9)	$C_{OUT} = 2.2\mu\text{F}$, $I_{LOAD} = 20\text{mA}$, $\text{BW} = 10\text{Hz}$ to 100kHz		92		μV_{RMS}
ADJ Pin Bias Current		-10	0.4	10	nA
Shutdown Threshold	$V_{OUT} = \text{Off}$ to On	●	0.67	1.5	V
	$V_{OUT} = \text{On}$ to Off	●	0.25	0.61	V
$\overline{\text{SHDN}}$ Pin Current	$V_{\overline{\text{SHDN}}} = 0\text{V}$, $V_{IN} = 45\text{V}$	●		± 1	μA
	$V_{\overline{\text{SHDN}}} = 45\text{V}$, $V_{IN} = 45\text{V}$	●	0.65	2	μA
Quiescent Current in Shutdown	$V_{IN} = 6\text{V}$, $V_{\overline{\text{SHDN}}} = 0\text{V}$	●		<1	μA
Ripple Rejection (Note 3)	$V_{IN} - V_{OUT} = 2\text{V}$, $V_{\text{RIPPLE}} = 0.5\text{V}_{\text{P-P}}$, $f_{\text{RIPPLE}} = 120\text{Hz}$, $I_{LOAD} = 20\text{mA}$				
	LT3008		58	70	dB
	LT3008-1.2		54	66	dB
	LT3008-1.5		53	65	dB
	LT3008-1.8		52	64	dB
	LT3008-2.5		49	61	dB
	LT3008-3.3		47	59	dB
	LT3008-5		42	54	dB

ELECTRICAL CHARACTERISTICS

The ● denotes the specifications which apply over the full operating temperature range, otherwise specifications are at $T_J = 25^\circ\text{C}$. (Note 2)

PARAMETER	CONDITIONS	MIN	TYP	MAX	UNITS
Current Limit	$V_{IN} = 45\text{V}, V_{OUT} = 0$		75		mA
	$V_{IN} = V_{OUT(\text{NOMINAL})} + 1\text{V}, \Delta V_{OUT} = -5\%$	● 22			mA
Input Reverse-Leakage Current	$V_{IN} = -45\text{V}, V_{OUT} = 0$	●	1	30	μA
Reverse-Output Current	$V_{OUT} = 1.2\text{V}, V_{IN} = 0$		0.6	10	μA

Note 1: Stresses beyond those listed under Absolute Maximum Ratings may cause permanent damage to the device. Exposure to any Absolute Maximum Rating condition for extended periods may affect device reliability and lifetime.

Note 2: The LT3008 regulators are tested and specified under pulse load conditions such that $T_J \cong T_A$. The LT3008E is 100% tested at $T_A = 25^\circ\text{C}$. Performance at -40°C and 125°C is assured by design, characterization and correlation with statistical process controls. The LT3008I is guaranteed over the full -40°C to 125°C operating junction temperature range. The LT3008MP is 100% tested and guaranteed over the -55°C to 125°C operating junction temperature range.

Note 3: The LT3008 adjustable version is tested and specified for these conditions with the ADJ pin connected to the OUT pin.

Note 4: Operating conditions are limited by maximum junction temperature. The regulated output voltage specification will not apply for all possible combinations of input voltage and output current. When operating at the maximum input voltage, the output current range must be limited. When operating at the maximum output current, the input voltage must be limited.

Note 5: Dropout voltage is the minimum input to output voltage differential needed to maintain regulation at a specified output current. In dropout, the output voltage equals $(V_{IN} - V_{\text{DROPOUT}})$. For the LT3008-1.2 and LT3008-1.5, dropout voltage will be limited by the minimum input voltage.

Note 6: To satisfy minimum input voltage requirements, the LT3008 adjustable version is tested and specified for these conditions with an external resistor divider (61.9k bottom, 280k top) which sets V_{OUT} to 3.3V. The external resistor divider adds $9.69\mu\text{A}$ of DC load on the output. This external current is not factored into GND pin current.

Note 7: GND pin current is tested with $V_{IN} = V_{OUT(\text{NOMINAL})} + 0.55\text{V}$ and a current source load. GND pin current will increase in dropout. For the fixed output voltage versions, an internal resistor divider will add about $1\mu\text{A}$ to the GND pin current. See the GND Pin Current curves in the Typical Performance Characteristics section.

Note 8: The $\overline{\text{SHDN}}$ pin can be driven below GND only when tied to the IN pin directly or through a pull-up resistor. If the $\overline{\text{SHDN}}$ pin is driven below GND by more than -0.3V while IN is powered, the output will turn on.

Note 9: Output noise is listed for the adjustable version with the ADJ pin connected to the OUT pin. See the RMS Output Noise vs Load Current curve in the Typical Performance Characteristics Section.

TYPICAL PERFORMANCE CHARACTERISTICS $T_A = 25^\circ\text{C}$, unless otherwise noted.

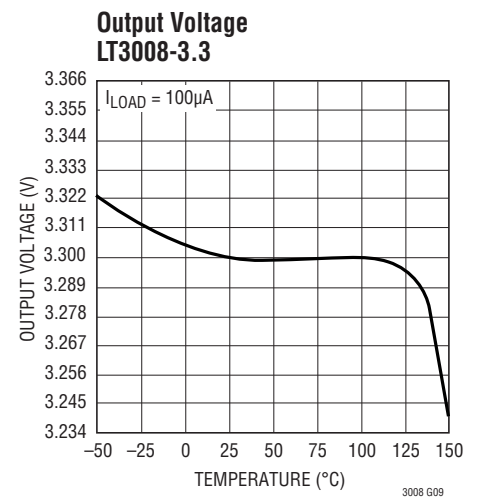
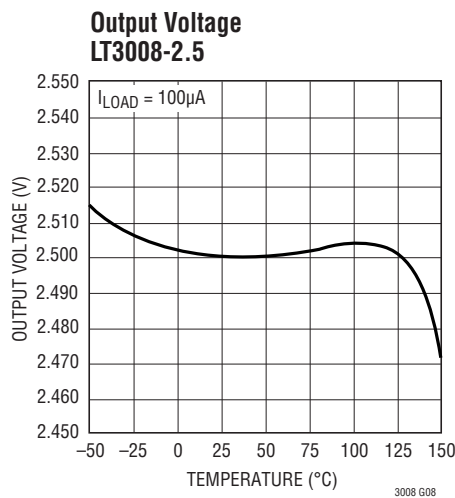
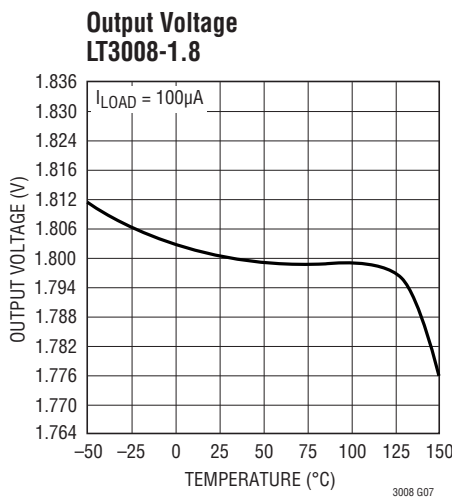
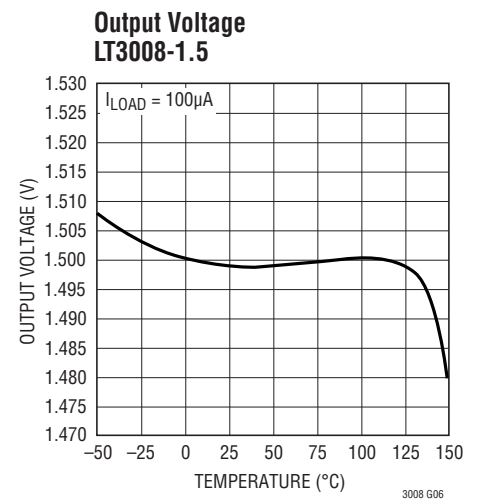
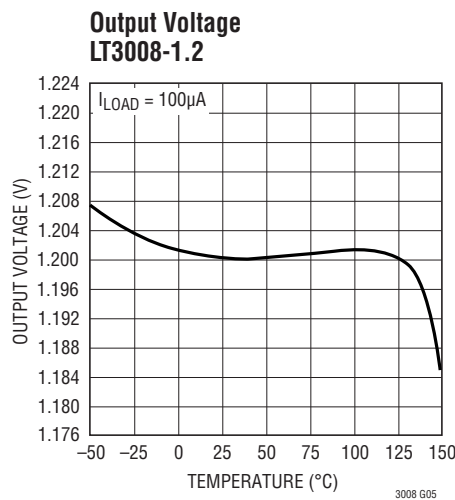
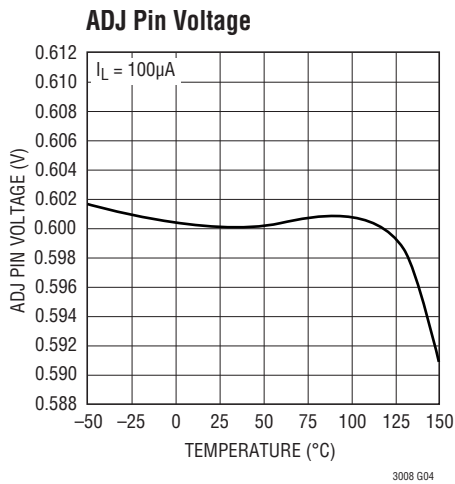
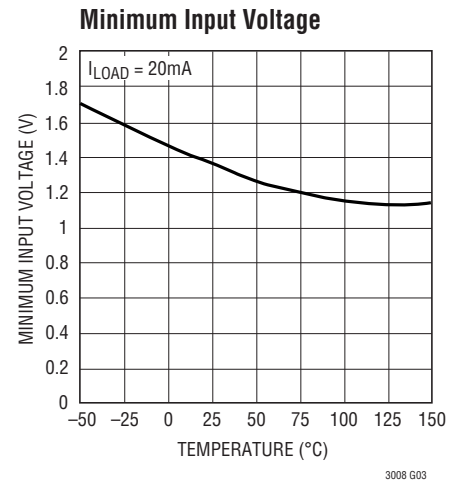
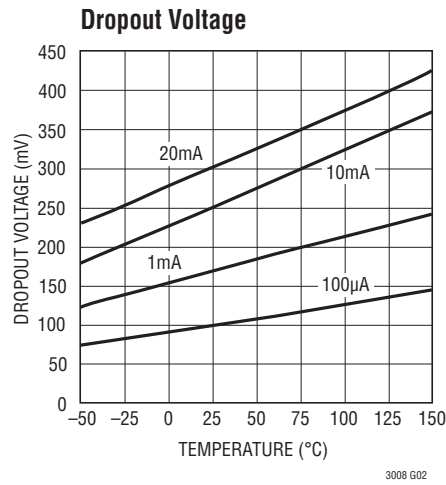
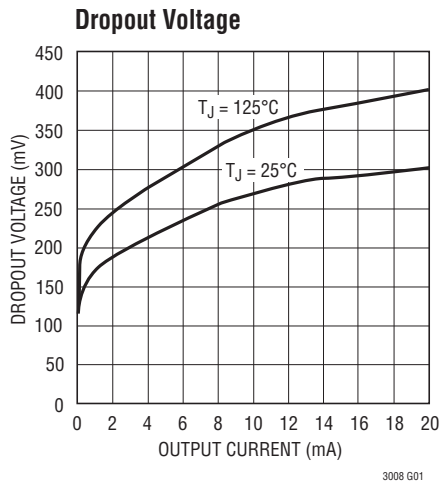

TYPICAL PERFORMANCE CHARACTERISTICS $T_A = 25^\circ\text{C}$, unless otherwise noted.

**Output Voltage
LT3008-5**

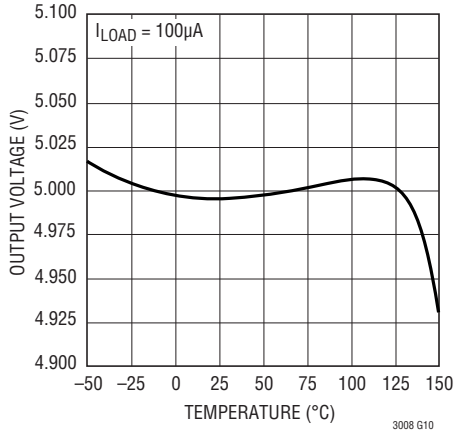

ADJ Pin Bias Current

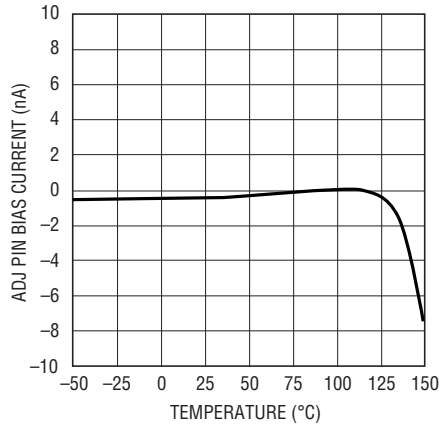

Adjustable Quiescent Current

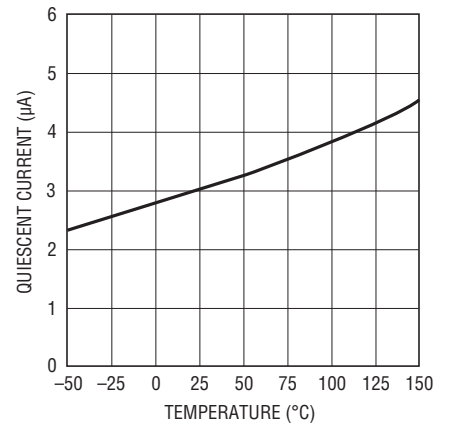

Quiescent Current

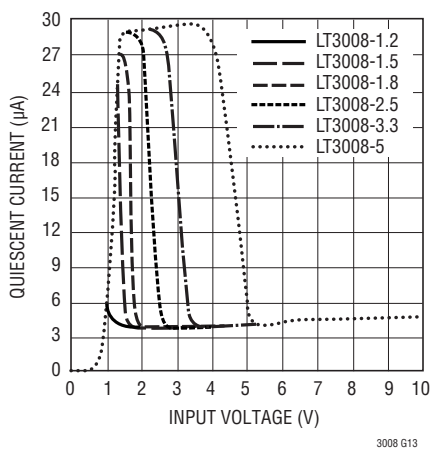

**GND Pin Current
LT3008-1.2**

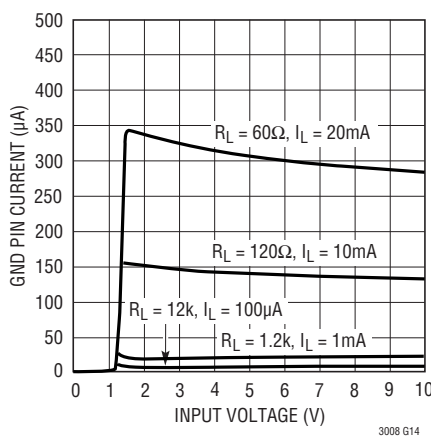

**GND Pin Current
LT3008-1.5**

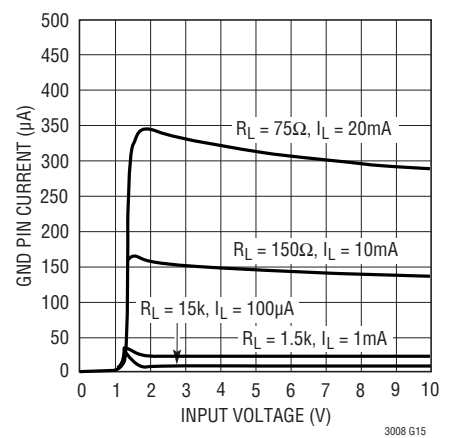

**GND Pin Current
LT3008-1.8**

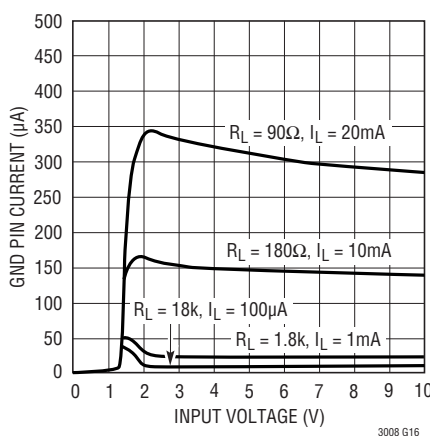

**GND Pin Current
LT3008-2.5**

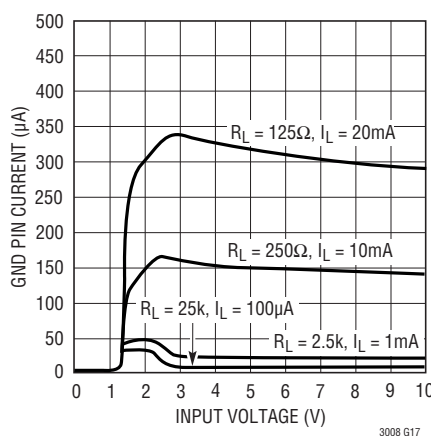

**GND Pin Current
LT3008-3.3**

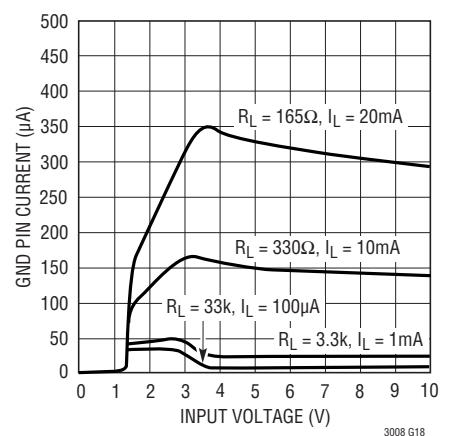

TYPICAL PERFORMANCE CHARACTERISTICS $T_A = 25^\circ\text{C}$, unless otherwise noted.

**GND Pin Current
LT3008-5**

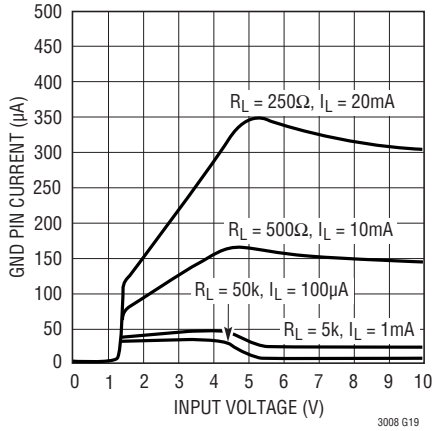

GND Pin Current vs I_{LOAD}

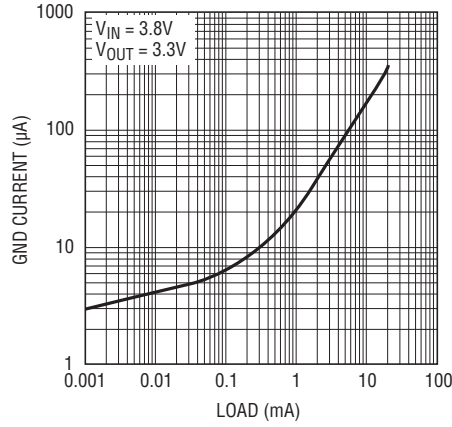

SHDN Pin Thresholds

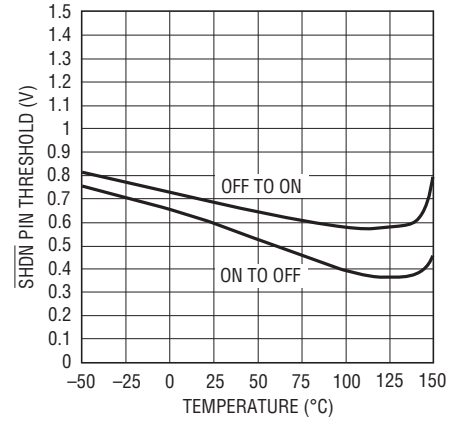

SHDN Pin Input Current

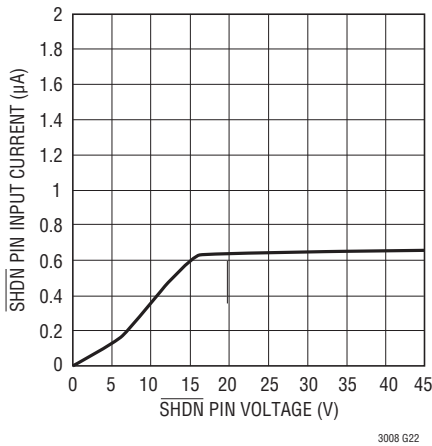

SHDN Pin Input Current

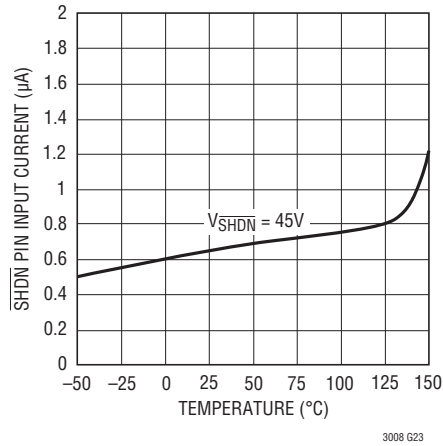

Current Limit

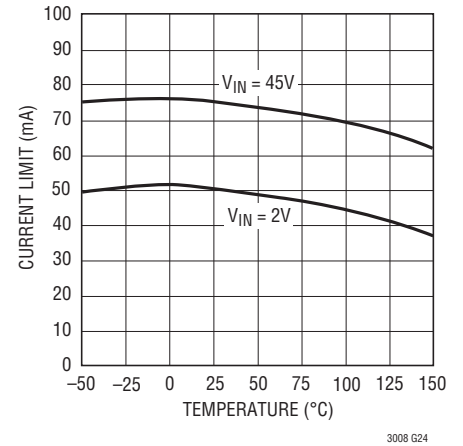

Reverse-Output Current

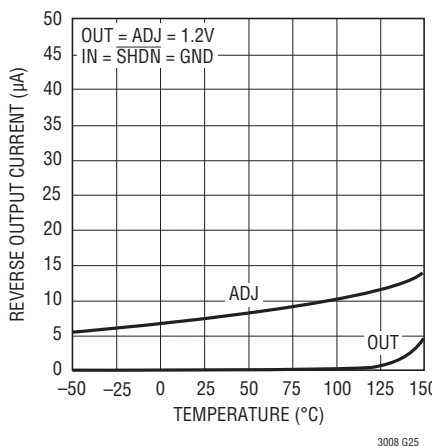

Input Ripple Rejection

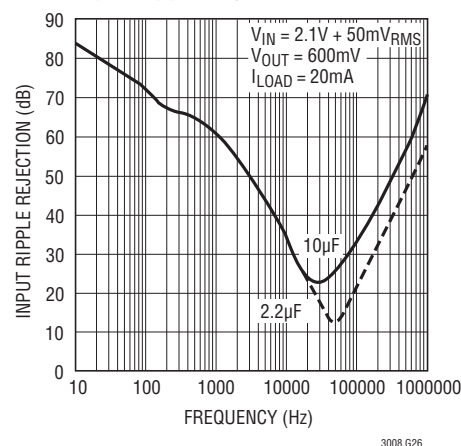

Input Ripple Rejection

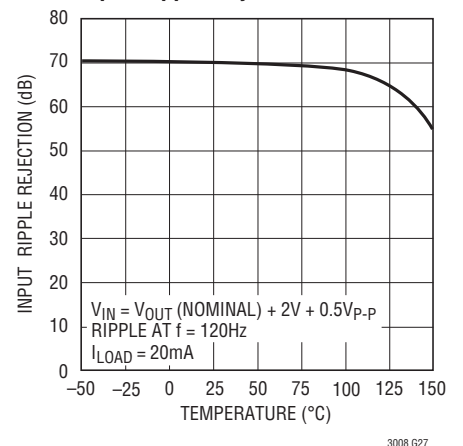

TYPICAL PERFORMANCE CHARACTERISTICS $T_A = 25^\circ\text{C}$, unless otherwise noted.

Load Regulation

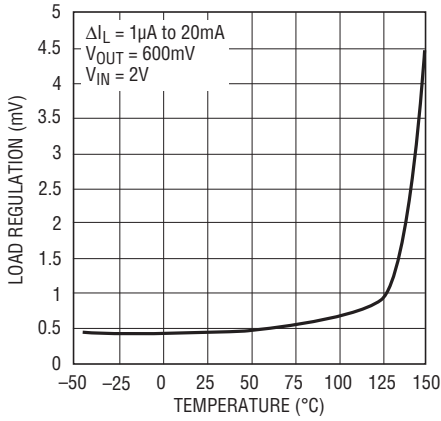

3008 G28

Output Noise Spectral Density

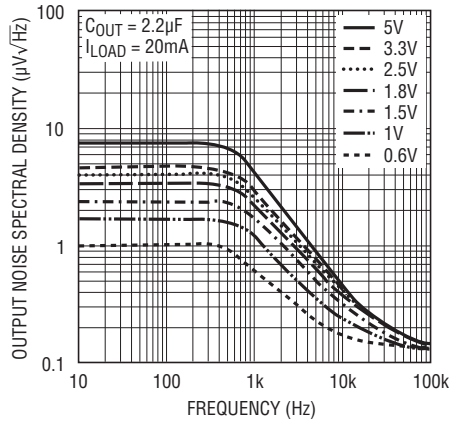

3008 G29

RMS Output Noise vs Load Current

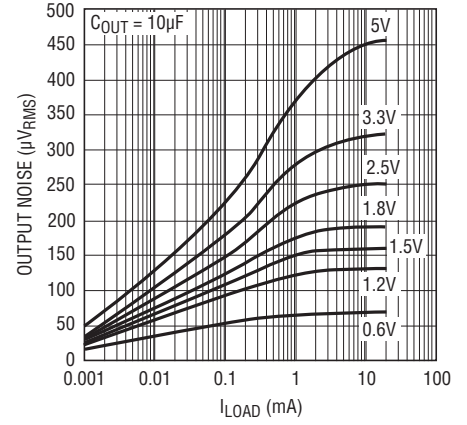

3008 G30

Transient Response

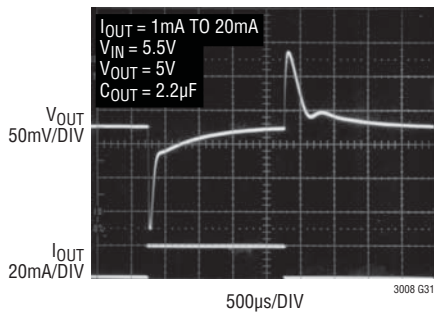

3008 G31

Transient Response

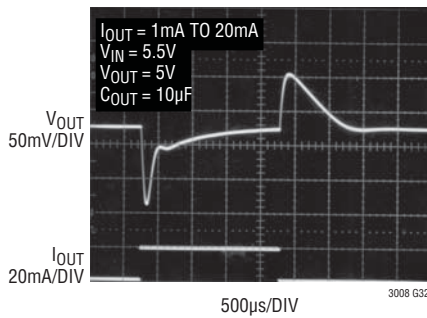

3008 G32

Transient Response (Load Dump)

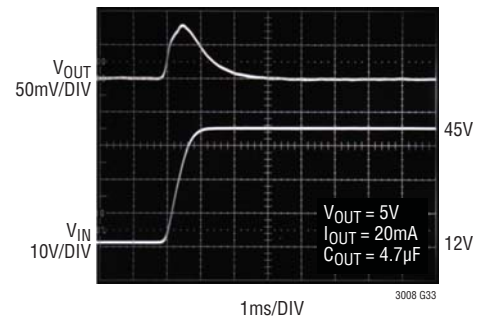

3008 G33

PIN FUNCTIONS (TSOT-23/DFN)

SHDN (Pin 1/Pin 5): Shutdown. Pulling the SHDN pin low puts the LT3008 into a low power state and turns the output off. If unused, tie the SHDN pin to V_{IN} . The LT3008 does not function if the SHDN pin is not connected. The SHDN pin cannot be driven below GND unless tied to the IN pin. If the SHDN pin is driven below GND while IN is powered, the output will turn on. SHDN pin logic cannot be referenced to a negative rail.

GND (Pins 2, 3, 4/Pin 6): Ground. Connect the bottom of the resistor divider that sets output voltage directly to GND for the best regulation.

IN (Pin 5/Pin 4): Input. The IN pin supplies power to the device. The LT3008 requires a bypass capacitor at IN if the device is more than six inches away from the main input filter capacitor. In general, the output impedance of a battery rises with frequency, so it is advisable to include a bypass capacitor in battery-powered circuits. A bypass capacitor in the range of 0.1 μ F to 10 μ F will suffice. The LT3008 withstands reverse voltages on the IN pin with respect to ground and the OUT pin. In the case of a reversed input, which occurs with a battery plugged in backwards, the LT3008 acts as if a blocking diode is in series with its input. No reverse current flows into the LT3008 and no reverse voltage appears at the load. The device protects both itself and the load.

OUT (Pin 6/Pins 2, 3): Output. This pin supplies power to the load. Use a minimum output capacitor of 2.2 μ F to prevent oscillations. Large load transient applications require larger output capacitors to limit peak voltage transients. See the Applications Information section for more information on output capacitance and reverse-output characteristics.

ADJ (Pin 7/Pin 1): Adjust. This pin is the error amplifier's inverting terminal. Its 400pA typical input bias current flows out of the pin (see curve of ADJ Pin Bias Current vs

Temperature in the Typical Performance Characteristics section). The ADJ pin voltage is 600mV referenced to GND and the output voltage range is 600mV to 44.5V.

NC (Pin 8, TSOT-23 Package Only): No Connect. Pin 8 is an NC pin in the TSOT-23 package. This pin is not tied to any internal circuitry. It may be floated, tied to V_{IN} or tied to GND.

GND (Exposed Pad Pin 7, DFN Package Only): Ground. The exposed pad (backside) of the DFN package is an electrical connection to GND. To ensure optimum performance, solder Pin 7 to the PCB and tie directly to Pin 6.

SENSE (Pin 7/Pin 1): Sense. For fixed voltage versions of the LT3008 (LT3008-1.2, LT3008-1.5, LT3008-1.8, LT3008-2.5, LT3008-3.3, LT3008-5), the SENSE pin is the input to the error amplifier. Optimum regulation is obtained at the point where the SENSE pin is connected to the OUT pin of the regulator. In critical applications, small voltage drops are caused by the resistance (R_P) of PC traces between the regulator and the load. These may be eliminated by connecting the SENSE pin to the output at the load as shown in Figure 1 (Kelvin Sense Connection). Note that the voltage drop across the external PC traces add to the dropout voltage of the regulator. The SENSE pin bias current is 1 μ A at the nominal rated output voltage. The SENSE pin can be pulled below ground (as in a dual supply system where the regulator load is returned to a negative supply) and still allow the device to start and operate.

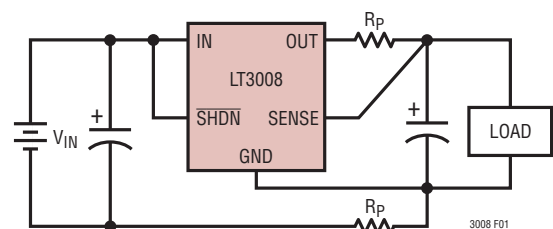

Figure 1. Kelvin Sense Connection

APPLICATIONS INFORMATION

The LT3008 is a low dropout linear regulator with ultra-low quiescent current and shutdown. Quiescent current is extremely low at 3μA and drops well below 1μA in shutdown. The device supplies up to 20mA of output current. Dropout voltage at 20mA is typically 300mV. The LT3008 incorporates several protection features, making it ideal for use in battery-powered systems. The device protects itself against both reverse-input and reverse-output voltages. In battery backup applications, where a backup battery holds up the output when the input is pulled to ground, the LT3008 acts as if a blocking diode is in series with its output and prevents reverse current flow. In applications where the regulator load returns to a negative supply, the output can be pulled below ground by as much as 50V without affecting start-up or normal operation.

Adjustable Operation

The LT3008 has an output voltage range of 0.6V to 44.5V. Figure 2 shows that output voltage is set by the ratio of two external resistors. The IC regulates the output to maintain the ADJ pin voltage at 600mV referenced to ground. The current in R1 equals 600mV/R1 and the current in R2 is the current in R1 minus the ADJ pin bias current. The ADJ pin bias current, typically 400pA at 25°C, flows out of the pin. Calculate the output voltage using the formula in Figure 2. An R1 value of 619k sets the divider current to 0.97μA. Do not make R1's value any greater than 619k to minimize output voltage errors due to the ADJ pin bias current and

to insure stability under minimum load conditions. In shutdown, the output turns off and the divider current is zero. Curves of ADJ Pin Voltage vs Temperature and ADJ Pin Bias Current vs Temperature appear in the Typical Performance Characteristics.

Specifications for output voltages greater than 0.6V are proportional to the ratio of the desired output voltage to 0.6V: $V_{OUT}/0.6V$. For example, load regulation for an output current change of 100μA to 20mA is -0.5mV typical at $V_{OUT} = 0.6V$. At $V_{OUT} = 5V$, load regulation is:

$$\frac{5V}{0.6V} \cdot (-0.5mV) = -4.17mV$$

Table 1 shows resistor divider values for some common output voltages with a resistor divider current of about 1μA.

Table 1. Output Voltage Resistor Divider Values

V _{OUT}	R1	R2
1V	604k	402k
1.2V	590k	590k
1.5V	590k	887k
1.8V	590k	1.18M
2.5V	590k	1.87M
3V	590k	2.37M
3.3V	619k	2.8M
5V	590k	4.32M

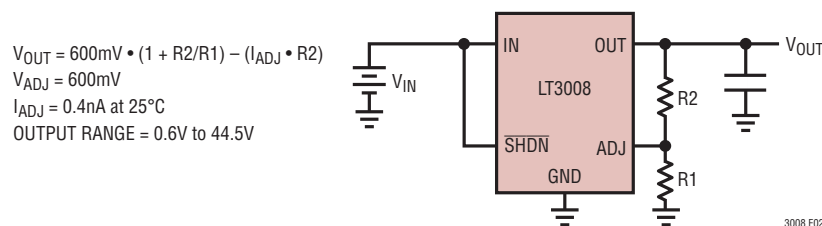

Figure 2. Adjustable Operation

3008 F02

APPLICATIONS INFORMATION

Because the ADJ pin is relatively high impedance (depending on the resistor divider used), stray capacitances at this pin should be minimized. Special attention should be given to any stray capacitances that can couple external signals onto the ADJ pin, producing undesirable output transients or ripple.

Extra care should be taken in assembly when using high valued resistors. Small amounts of board contamination can lead to significant shifts in output voltage. Appropriate post-assembly board cleaning measures should be implemented to prevent board contamination. If the board is to be subjected to humidity cycling or if board cleaning measures cannot be guaranteed, consideration should be given to using resistors an order of magnitude smaller than in Table 1 to prevent contamination from causing unwanted shifts in the output voltage. A fixed voltage option in the LT3008 series will not need these special considerations.

Output Capacitance and Transient Response

The LT3008 is stable with a wide range of output capacitors. The ESR of the output capacitor affects stability, most notably with small capacitors. Use a minimum output capacitor of 2.2 μ F with an ESR of 3 Ω or less to prevent oscillations. The LT3008 is a micropower device and output load transient response is a function of output capacitance. Larger values of output capacitance decrease the peak deviations and provide improved transient response for larger load current changes.

Give extra consideration to the use of ceramic capacitors. Manufacturers make ceramic capacitors with a variety of dielectrics, each with different behavior across temperature and applied voltage. The most common dielectrics are specified with EIA temperature characteristic codes of Z5U, Y5V, X5R and X7R. The Z5U and Y5V dielectrics provide high C-V products in a small package at low cost, but exhibit strong voltage and temperature coefficients as shown in Figures 3 and 4. When used with a 5V regulator, a 16V 10 μ F Y5V capacitor can exhibit an effective value as low as 1 μ F to 2 μ F for the DC bias voltage applied and over the operating temperature range. The X5R and X7R dielectrics yield more stable characteristics and are more suitable for use as the output capacitor. The X7R type has better stability across temperature, while the X5R is less expensive and is available in higher values. One must still exercise care when using X5R and X7R capacitors; the X5R and X7R codes only specify operating temperature range and maximum capacitance change over temperature. Capacitance change due to DC bias with X5R and X7R capacitors is better than Y5V and Z5U capacitors, but can still be significant enough to drop capacitor values below appropriate levels. Capacitor DC bias characteristics tend to improve as component case size increases, but expected capacitance at operating voltage should be verified.

Voltage and temperature coefficients are not the only sources of problems. Some ceramic capacitors have a

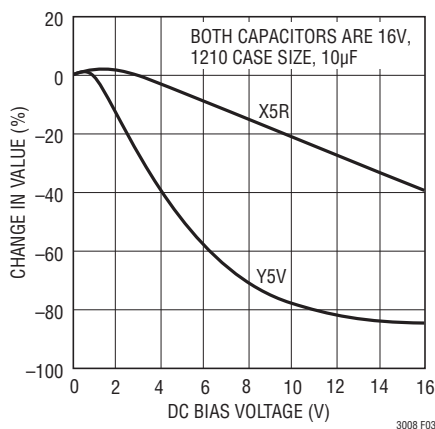

Figure 3. Ceramic Capacitor DC Bias Characteristics

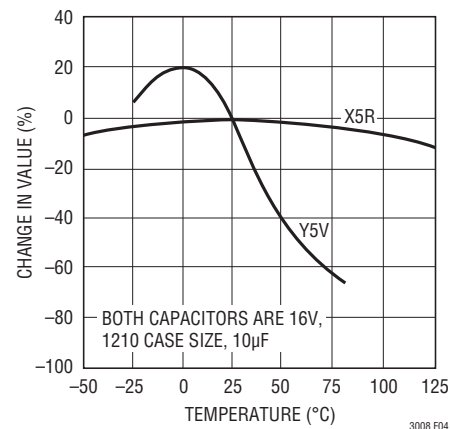

Figure 4. Ceramic Capacitor Temperature Characteristics

APPLICATIONS INFORMATION

piezoelectric response. A piezoelectric device generates voltage across its terminals due to mechanical stress, similar to the way a piezoelectric accelerometer or microphone works. For a ceramic capacitor, the stress can be induced by vibrations in the system or thermal transients. The resulting voltages produced can cause appreciable amounts of noise, especially when a ceramic capacitor is used for noise bypassing. A ceramic capacitor produced Figure 5's trace in response to light tapping from a pencil. Similar vibration induced behavior can masquerade as increased output voltage noise.

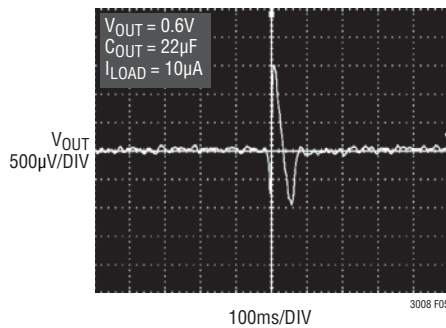

Figure 5. Noise Resulting from Tapping on a Ceramic Capacitor

Thermal Considerations

The LT3008's maximum rated junction temperature of 125°C limits its power-handling capability. Two components comprise the power dissipated by the device:

1. Output current multiplied by the input/output voltage differential: $I_{OUT} \cdot (V_{IN} - V_{OUT})$
2. GND pin current multiplied by the input voltage: $I_{GND} \cdot V_{IN}$

GND pin current is found by examining the GND Pin Current curves in the Typical Performance Characteristics section. Power dissipation is equal to the sum of the two components listed prior.

The LT3008 regulator has internal thermal limiting designed to protect the device during overload conditions. For continuous normal conditions, do not exceed the maximum junction temperature rating of 125°C. Carefully consider all sources of thermal resistance from junction to ambient including other heat sources mounted in proximity to the LT3008. For surface mount devices, heat sinking is accomplished by using the heat spreading capabilities of the PC board and its copper traces. Copper board stiffeners and plated through-holes can also be used to spread the heat generated by power devices.

The following tables list thermal resistance for several different board sizes and copper areas. All measurements were taken in still air on 3/32" FR-4 two-layer boards with one ounce copper.

PCB layers, copper weight, board layout and thermal vias affect the resultant thermal resistance. Although Tables 2 and 3 provide thermal resistance numbers for 2-layer boards with 1 ounce copper, modern multilayer PCBs provide better performance than found in these tables.

Table 2: Measured Thermal Resistance for DC Package

COPPER AREA		BOARD AREA	THERMAL RESISTANCE (JUNCTION-TO-AMBIENT)
TOPSIDE*	BACKSIDE		
2500mm ²	2500mm ²	2500mm ²	65°C/W
1000mm ²	2500mm ²	2500mm ²	70°C/W
225mm ²	2500mm ²	2500mm ²	75°C/W
100mm ²	2500mm ²	2500mm ²	80°C/W
50mm ²	2500mm ²	2500mm ²	85°C/W

*Device is mounted on the topside.

APPLICATIONS INFORMATION

Table 3: Measured Thermal Resistance for TSOT-23 Package

COPPER AREA		BOARD AREA	THERMAL RESISTANCE (JUNCTION-TO-AMBIENT)
TOPSIDE*	BACKSIDE		
2500mm ²	2500mm ²	2500mm ²	65°C/W
1000mm ²	2500mm ²	2500mm ²	67°C/W
225mm ²	2500mm ²	2500mm ²	70°C/W
100mm ²	2500mm ²	2500mm ²	75°C/W
50mm ²	2500mm ²	2500mm ²	85°C/W

*Device is mounted on the topside.

For example, a 4-layer, 1 ounce copper PCB board with 3 thermal vias from the DFN exposed backside or the 3 fused TSOT-23 GND pins to inner layer GND planes achieves 45°C/W thermal resistance. Demo circuit DC 1388A's board layout achieves this 45°C/W performance. This is approximately a 30% improvement over the lowest numbers shown in Tables 2 and 3.

Calculating Junction Temperature

Example: Given an output voltage of 3.3V, an input voltage range of 12V ±5%, an output current range of 0mA to 20mA and a maximum ambient temperature of 85°C, what will the maximum junction temperature be for an application using the DC package?

The power dissipated by the device is equal to:

$$I_{OUT(MAX)} (V_{IN(MAX)} - V_{OUT}) + I_{GND} (V_{IN(MAX)})$$

where,

$$I_{OUT(MAX)} = 20\text{mA}$$

$$V_{IN(MAX)} = 12.6\text{V}$$

$$I_{GND} \text{ at } (I_{OUT} = 20\text{mA}, V_{IN} = 12.6\text{V}) = 0.3\text{mA}$$

So,

$$P = 20\text{mA}(12.6\text{V} - 3.3\text{V}) + 0.3\text{mA}(12.6\text{V}) = 189.8\text{mW}$$

The thermal resistance ranges from 65°C/W to 85°C/W depending on the copper area. So, the junction temperature rise above ambient approximately equals:

$$0.1898\text{W}(75^\circ\text{C/W}) = 14.2^\circ\text{C}$$

The maximum junction temperature equals the maximum junction temperature rise above ambient plus the maximum ambient temperature or:

$$T_{J(MAX)} = 85^\circ\text{C} + 14.2^\circ\text{C} = 99.2^\circ\text{C}$$

Protection Features

The LT3008 incorporates several protection features that make it ideal for use in battery-powered circuits. In addition to the normal protection features associated with monolithic regulators, such as current limiting and thermal limiting, the device also protects against reverse-input voltages, reverse-output voltages and reverse output-to-input voltages.

Current limit protection and thermal overload protection protect the device against current overload conditions at the output of the device. For normal operation, do not exceed a junction temperature of 125°C. The typical thermal shutdown circuitry temperature threshold is 160°C.

The IN pin withstands reverse voltages of 50V. The device limits current flow to less than 30µA (typically less than 1µA) and no negative voltage appears at OUT. The device protects both itself and the load against batteries that are plugged in backwards.

APPLICATIONS INFORMATION

The $\overline{\text{SHDN}}$ pin cannot be driven below GND unless tied to the IN pin. If the $\overline{\text{SHDN}}$ pin is driven below GND while IN is powered, the output will turn on. $\overline{\text{SHDN}}$ pin logic cannot be referenced to a negative rail.

The LT3008 incurs no damage if OUT is pulled below ground. If IN is left open circuit or grounded, OUT can be pulled below ground by 50V. No current flows from the pass transistor connected to OUT. However, current flows in (but is limited by) the resistor divider that sets output voltage. Current flows from the bottom resistor in the divider and from the ADJ pin's internal clamp through the top resistor in the divider to the external circuitry pulling OUT below ground. If IN is powered by a voltage source, OUT sources current equal to its current limit capability and the LT3008 protects itself by thermal limiting if necessary. In this case, grounding the $\overline{\text{SHDN}}$ pin turns off the LT3008 and stops OUT from sourcing current.

The LT3008 incurs no damage if the ADJ pin is pulled above or below ground by 50V. If IN is left open circuit or grounded, ADJ acts like a 100k resistor in series with a diode when pulled above or below ground.

In circuits where a backup battery is required, several different input/output conditions can occur. The output voltage may be held up while the input is either pulled

to ground, pulled to some intermediate voltage or is left open circuit. Current flow back into the output follows the curve shown in Figure 6.

If the LT3008 IN pin is forced below the OUT pin or the OUT pin is pulled above the IN pin, input current typically drops to less than $1\mu\text{A}$. This occurs if the LT3008 input is connected to a discharged (low voltage) battery and either a backup battery or a second regulator circuit holds up the output. The state of the $\overline{\text{SHDN}}$ pin has no effect in the reverse current if OUT is pulled above IN.

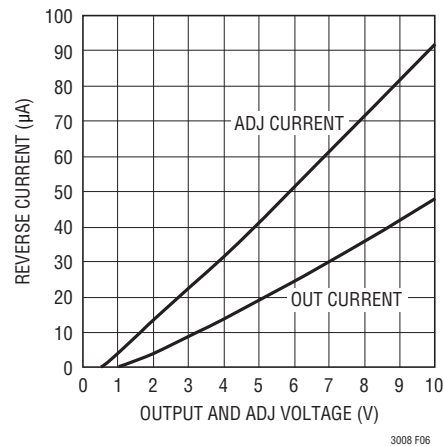
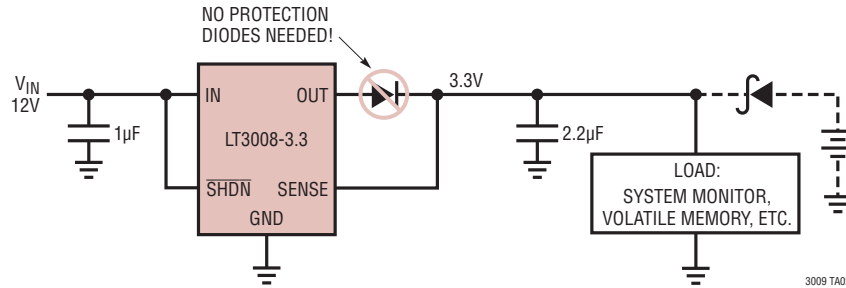

Figure 6. Reverse-Output Current

TYPICAL APPLICATIONS

Keep-Alive Power Supply



Last-Gasp Circuit

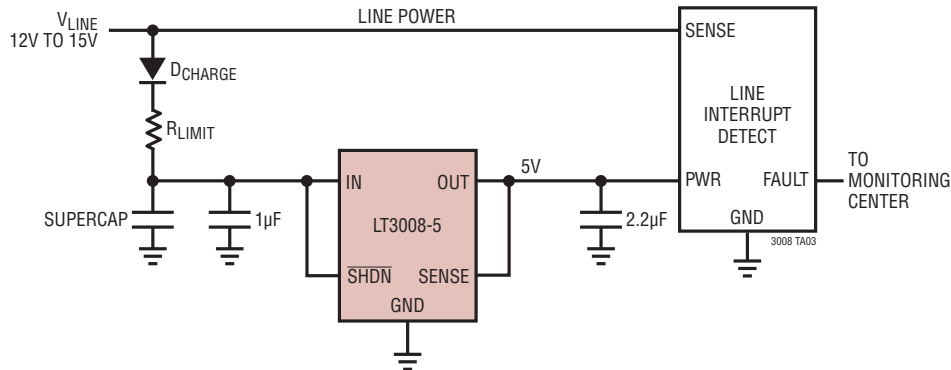

PACKAGE DESCRIPTION

DC Package 6-Lead Plastic DFN (2mm × 2mm) (Reference LTC DWG # 05-08-1703)

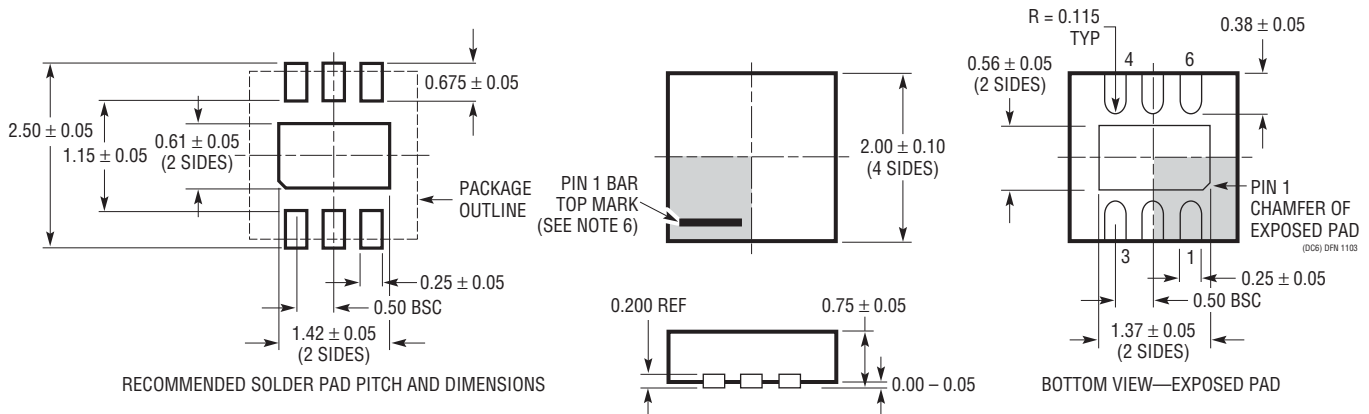

NOTE:

1. DRAWING TO BE MADE A JEDEC PACKAGE OUTLINE M0-229 VARIATION OF (WCCD-2)
2. DRAWING NOT TO SCALE
3. ALL DIMENSIONS ARE IN MILLIMETERS
4. DIMENSIONS OF EXPOSED PAD ON BOTTOM OF PACKAGE DO NOT INCLUDE MOLD FLASH. MOLD FLASH, IF PRESENT, SHALL NOT EXCEED 0.15mm ON ANY SIDE

5. EXPOSED PAD SHALL BE SOLDER PLATED
6. SHADED AREA IS ONLY A REFERENCE FOR PIN 1 LOCATION ON THE TOP AND BOTTOM OF PACKAGE

PACKAGE DESCRIPTION

TS8 Package 8-Lead Plastic TSOT-23

(Reference LTC DWG # 05-08-1639 Rev 0)

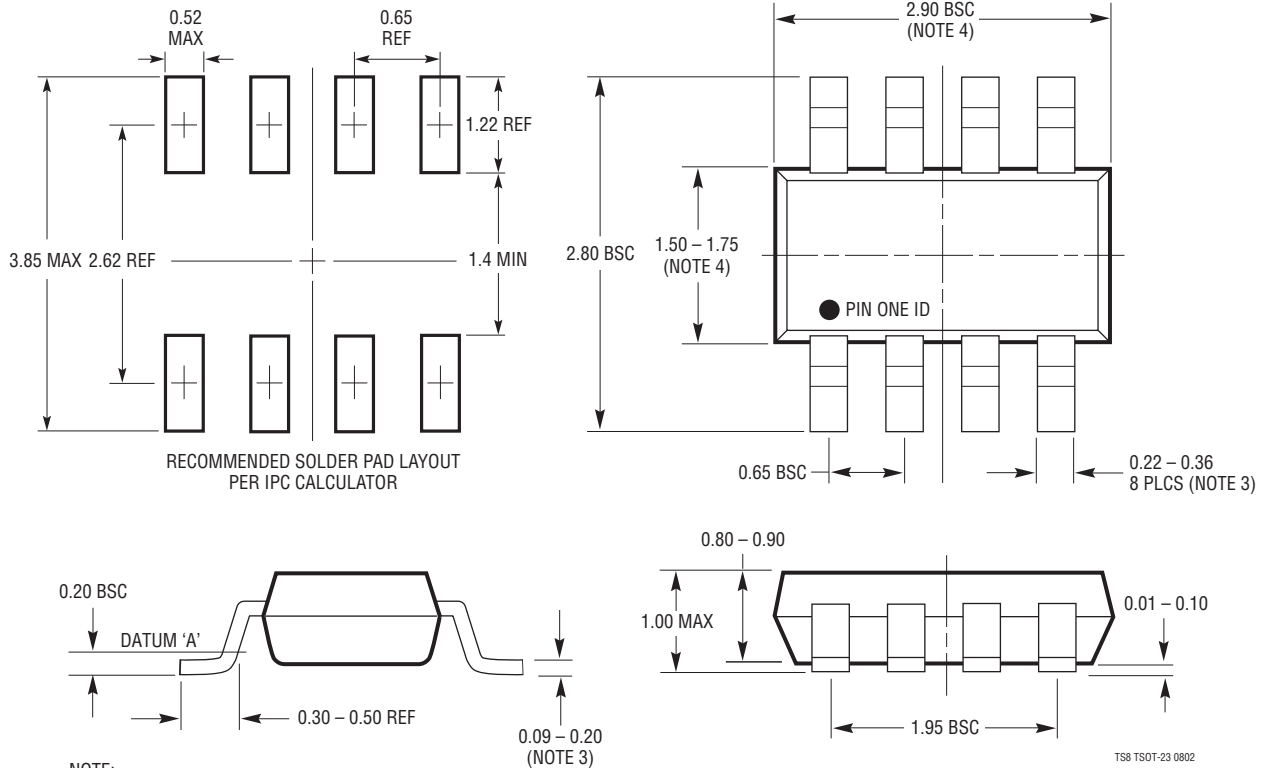

NOTE:

1. DIMENSIONS ARE IN MILLIMETERS
2. DRAWING NOT TO SCALE
3. DIMENSIONS ARE INCLUSIVE OF PLATING
4. DIMENSIONS ARE EXCLUSIVE OF MOLD FLASH AND METAL BURR
5. MOLD FLASH SHALL NOT EXCEED 0.254mm
6. JEDEC PACKAGE REFERENCE IS MO-193

TS8 TSOT-23 0802

REVISION HISTORY (Revision history begins at Rev B)

REV	DATE	DESCRIPTION	PAGE NUMBER
B	02/10	Added MP grade in TS8 package Revised curve G04 in Typical Performance Characteristics	2-4, 6 7

TYPICAL APPLICATION

Low Duty Cycle Applications

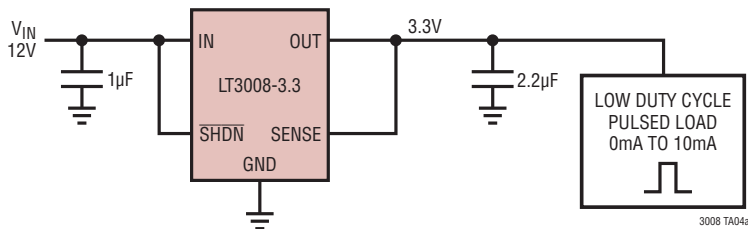

Average Power Savings for Low Duty Cycle Applications 0mA to 10mA Pulsed Load, $I_N = 12V$

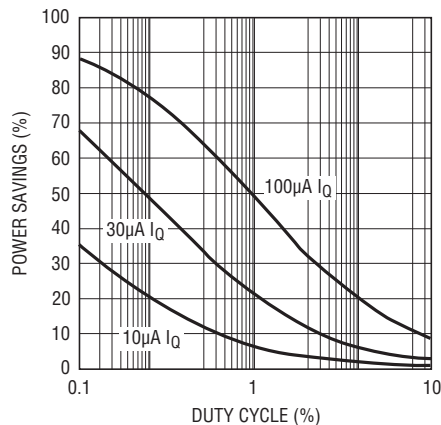

RELATED PARTS

PART NUMBER	DESCRIPTION	COMMENTS
LT1761	100mA, Low Noise Micropower LDO	V_{IN} : 1.8V to 20V, V_{OUT} = 1.22V, V_{DO} = 0.3V, I_Q = 20µA, I_{SD} < 1µA, Low Noise: < 20µV _{RMS} , Stable with 1µF Ceramic Capacitors, ThinSOT™ Package
LT1762	150mA, Low Noise Micropower LDO	V_{IN} : 1.8V to 20V, V_{OUT} = 1.22V, V_{DO} = 0.3V, I_Q = 25µA, I_{SD} < 1µA, Low Noise: < 20µV _{RMS} , MS8 Package
LT1763	500mA, Low Noise Micropower LDO	V_{IN} : 1.8V to 20V, V_{OUT} = 1.22V, V_{DO} = 0.3V, I_Q = 30µA, I_{SD} < 1µA, Low Noise: < 20µV _{RMS} , S8 Package
LT1764/LT1764A	3A, Low Noise, Fast Transient Response LDOs	V_{IN} : 2.7V to 20V, V_{OUT} = 1.21V, V_{DO} = 0.34V, I_Q = 1mA, I_{SD} < 1µA, Low Noise: < 40µV _{RMS} , LT1764A Version Stable with Ceramic Capacitors, DD and TO220-5 Packages
LT1962	300mA, Low Noise Micropower LDO	V_{IN} : 1.8V to 20V, $V_{OUT(MIN)}$ = 1.22V, V_{DO} = 0.27V, I_Q = 30µA, I_{SD} < 1µA, Low Noise: < 20µV _{RMS} , MS8 Package
LT1963/LT1963A	1.5A, Low Noise, Fast Transient Response LDOs	V_{IN} : 2.1V to 20V, $V_{OUT(MIN)}$ = 1.21V, V_{DO} = 0.34V, I_Q = 1mA, I_{SD} < 1µA, Low Noise: < 40µV _{RMS} , LT1963A Version Stable with Ceramic Capacitors, DD, TO220-5, SOT223 and S8 Packages
LT3009	20mA, 3µA I_Q Micropower LDO	V_{IN} : 1.6V to 20V, Low I_Q : 3µA, V_{DO} = 0.28V, 2mm × 2mm DFN and SC70-8 Packages
LT3020	100mA, Low Voltage VLDO	V_{IN} : 0.9V to 10V, $V_{OUT(MIN)}$ = 0.20V, V_{DO} = 0.15V, I_Q = 120µA, I_{SD} < 1µA, 3mm × 3mm DFN and MS8 Packages
LT3021	500mA, Low Voltage VLDO	V_{IN} : 0.9V to 10V, $V_{OUT(MIN)}$ = 0.20V, V_{DO} = 0.16V, I_Q = 120µA, I_{SD} < 3µA, 5mm × 5mm DFN and S08 Packages
LT3080/ LT3080-1	1.1A, Parallelable, Low Noise, Low Dropout Linear Regulator	300mV Dropout Voltage (2-Supply Operation), Low Noise: 40µV _{RMS} , V_{IN} : 1.2V to 36V, V_{OUT} : 0V to 35.7V, Current-Based Reference with 1-Resistor V_{OUT} Set; Directly Parallelable (No Op Amp Required), Stable with Ceramic Caps, TO-220, SOT-223, MSOP and 3mm × 3mm DFN Packages; LT3080-1 Version Has Integrated Internal Ballast Resistor
LT3085	500mA, Parallelable, Low Noise, Low Dropout Linear Regulator	275mV Dropout Voltage (2-Supply Operation), Low Noise: 40µV _{RMS} , V_{IN} : 1.2V to 36V, V_{OUT} : 0V to 35.7V, Current-Based Reference with 1-Resistor V_{OUT} Set; Directly Parallelable (No Op Amp Required), Stable with Ceramic Caps, MSOP-8 and 2mm × 3mm DFN Packages

ThinSOT is a trademark of Linear Technology Corporation.



- [中文网站](#)
- [日本サイト](#)
- [Quality](#)
- [Careers](#)
- [Contact Us](#)
- [MyLinear](#)



- [PRODUCTS](#)
- [SOLUTIONS](#)
- [DESIGN SUPPORT](#)
- [PURCHASE](#)
- [COMPANY](#)

Linear Regulators (LDO)

[Home](#) > [Products](#) > [Power Management](#) > [Linear Regulators \(LDO\)](#) > [Positive Linear Regulators \(LDO\)](#) > [LT3008](#)

- [Positive Linear Regulators \(LDO\)](#)
- [Negative Linear Regulators \(LDO\)](#)
- [Discrete Pass Element Linear Regulators \(LDO\)](#)

LT3008 Series - 3A IQ, 20mA, 45V Low Dropout Linear Regulators

- **FEATURES**
- DESCRIPTION
- PACKAGING
- ORDER INFO
- SIMULATE
- [Print Friendly](#)

Features

- [Click Here for LT3008 Evaluation Kit](#)
- **Ultralow Quiescent Current: 3•A**
- **Input Voltage Range: 2.0V to 45V**
- **Output Current: 20mA**
- **Dropout Voltage: 300mV**
- **Adjustable Output ($V_{ADJ} = V_{OUT(MIN)} = 600mV$)**
- **Fixed Output Voltages: 1.2V, 1.5V, 1.8V, 2.5V, 3.3V, 5V**
- Output Tolerance: $\pm 2\%$ Over Load, Line and Temperature
- Stable with Low ESR, Ceramic Output Capacitors (2.2•F Minimum)
- Shutdown Current: $< 1•A$
- Current Limit Protection
- Reverse-Battery Protection
- Thermal Limit Protection
- TSOT-23 and 2mm \times 2mm DFN Packages

Typical Application

3.3V, 20mA Supply with Shutdown

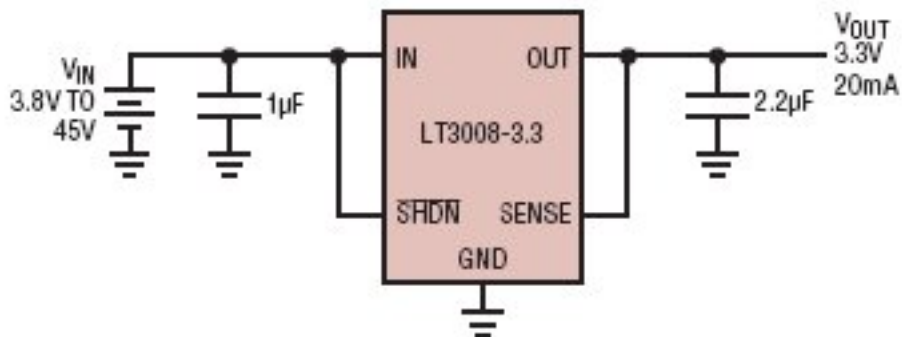

Dropout Voltage/Quiescent Current

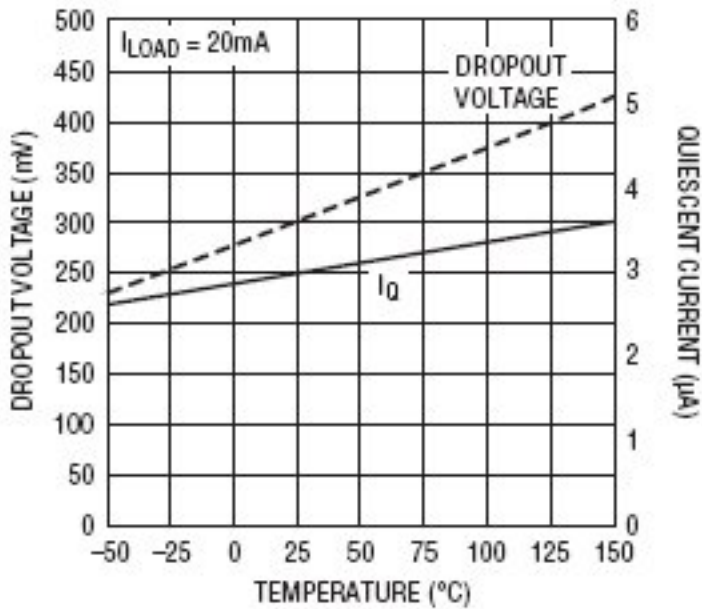

[Back to Top](#)

Description

The LT®3008 series are micropower, low dropout voltage (LDO) linear regulators. The devices supply 20mA output current with a dropout voltage of 300mV. No-load quiescent current is 3•A. Ground pin current remains at less than 5% of output current as load increases. In shutdown, quiescent current is less than 1•A.

The LT3008 regulators optimize stability and transient response with low ESR ceramic capacitors, requiring a minimum of only 2.2•F. The regulators do not require the addition of ESR as is common with other regulators. Internal protection circuitry includes current limiting, thermal limiting, reverse-battery protection and reverse current protection.

The LT3008 series are ideal for applications that require moderate output drive capability coupled with ultralow standby power consumption. The device is available in fixed output voltages of 1.2V, 1.5V, 1.8V, 2.5V, 3.3V and 5V, and an adjustable version with an output voltage range of 0.6V to 44.5V. The LT3008 is available in the thermally enhanced 6-lead DFN and 8-lead TSOT-23 packages.

[Back to Top](#)

Packaging

DFN-6, SOT-23

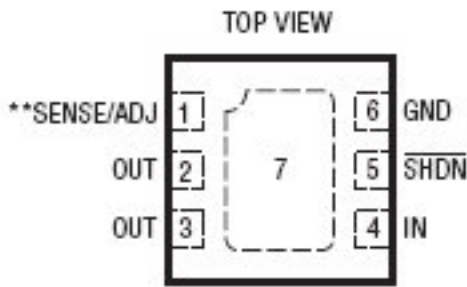

DC PACKAGE
6-LEAD (2mm × 2mm) PLASTIC DFN

$T_{JMAX} = 125^{\circ}C$, $\theta_{JA} = 65^{\circ}C/W$ TO $85^{\circ}C/W$ *
EXPOSED PAD (PIN 7) IS GND, MUST BE SOLDERED TO PCB

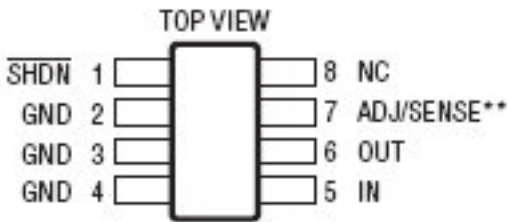

TS8 PACKAGE
8-LEAD PLASTIC TSOT-23

$T_{JMAX} = 125^{\circ}C$, $\theta_{JA} = 65^{\circ}C/W$ TO $85^{\circ}C/W$ *

[Back to Top](#)

Order Info

- Part numbers ending in PBF are [lead free](#). Please contact LTC marketing for information on lead based finish parts.
- Part numbers containing TR or TRM are shipped in [tape and reel or 500 unit mini tape and reel](#), respectively
- Please refer to our [general ordering information](#) or the product datasheet for more details

Package Variations and Pricing

Part Number	Package	Pins	Temp	Price (1-99)	Price (1k)*	RoHS Data
LT3008EDC#PBF	DFN	6	E	\$1.71		View
LT3008EDC#TRMPBF	DFN	6	E	\$1.71	\$1.25	View
LT3008EDC#TRPBF	DFN	6	E	\$1.71	\$1.20	View
LT3008EDC-1.2#PBF	DFN	6	E	\$1.71		View
LT3008EDC-1.2#TRMPBF	DFN	6	E	\$1.71	\$1.25	View
LT3008EDC-1.2#TRPBF	DFN	6	E	\$1.71	\$1.20	View

LT3008EDC-1.5#PBF	DFN	6	E	\$1.71		View
LT3008EDC-1.5#TRMPBF	DFN	6	E	\$1.71	\$1.25	View
LT3008EDC-1.5#TRPBF	DFN	6	E	\$1.71	\$1.20	View
LT3008EDC-1.8#PBF	DFN	6	E	\$1.71		View
LT3008EDC-1.8#TRMPBF	DFN	6	E	\$1.71	\$1.25	View
LT3008EDC-1.8#TRPBF	DFN	6	E	\$1.71	\$1.20	View
LT3008EDC-2.5#PBF	DFN	6	E	\$1.71		View
LT3008EDC-2.5#TRMPBF	DFN	6	E	\$1.71	\$1.25	View
LT3008EDC-2.5#TRPBF	DFN	6	E	\$1.71	\$1.20	View
LT3008EDC-3.3#PBF	DFN	6	E	\$1.71		View
LT3008EDC-3.3#TRMPBF	DFN	6	E	\$1.71	\$1.25	View
LT3008EDC-3.3#TRPBF	DFN	6	E	\$1.71	\$1.20	View
LT3008EDC-5#PBF	DFN	6	E	\$1.71		View
LT3008EDC-5#TRMPBF	DFN	6	E	\$1.71	\$1.25	View
LT3008EDC-5#TRPBF	DFN	6	E	\$1.71	\$1.20	View
LT3008ETS8#PBF	SOT	8	E	\$1.71		View
LT3008ETS8#TRMPBF	SOT	8	E	\$1.71	\$1.25	View
LT3008ETS8#TRPBF	SOT	8	E	\$1.71	\$1.20	View
LT3008ETS8-1.2#PBF	SOT	8	E	\$1.71		View
LT3008ETS8-1.2#TRMPBF	SOT	8	E	\$1.71	\$1.25	View
LT3008ETS8-1.2#TRPBF	SOT	8	E	\$1.71	\$1.20	View
LT3008ETS8-1.5#PBF	SOT	8	E	\$1.71		View
LT3008ETS8-1.5#TRMPBF	SOT	8	E	\$1.71	\$1.25	View
LT3008ETS8-1.5#TRPBF	SOT	8	E	\$1.71	\$1.20	View
LT3008ETS8-1.8#PBF	SOT	8	E	\$1.71		View
LT3008ETS8-1.8#TRMPBF	SOT	8	E	\$1.71	\$1.25	View
LT3008ETS8-1.8#TRPBF	SOT	8	E	\$1.71	\$1.20	View
LT3008ETS8-2.5#PBF	SOT	8	E	\$1.71		View
LT3008ETS8-2.5#TRMPBF	SOT	8	E	\$1.71	\$1.25	View

LT3008ETS8-2.5#TRPBF	SOT	8	E	\$1.71	\$1.20	View
LT3008ETS8-3.3#PBF	SOT	8	E	\$1.71		View
LT3008ETS8-3.3#TRMPBF	SOT	8	E	\$1.71	\$1.25	View
LT3008ETS8-3.3#TRPBF	SOT	8	E	\$1.71	\$1.20	View
LT3008ETS8-5#PBF	SOT	8	E	\$1.71		View
LT3008ETS8-5#TRMPBF	SOT	8	E	\$1.71	\$1.25	View
LT3008ETS8-5#TRPBF	SOT	8	E	\$1.71	\$1.20	View
LT3008IDC#PBF	DFN	6	I	\$2.00		View
LT3008IDC#TRMPBF	DFN	6	I	\$2.00	\$1.45	View
LT3008IDC#TRPBF	DFN	6	I	\$2.00	\$1.40	View
LT3008IDC-1.2#PBF	DFN	6	I	\$2.00		View
LT3008IDC-1.2#TRMPBF	DFN	6	I	\$2.00	\$1.45	View
LT3008IDC-1.2#TRPBF	DFN	6	I	\$2.00	\$1.40	View
LT3008IDC-1.5#PBF	DFN	6	I	\$2.00		View
LT3008IDC-1.5#TRMPBF	DFN	6	I	\$2.00	\$1.45	View
LT3008IDC-1.5#TRPBF	DFN	6	I	\$2.00	\$1.40	View
LT3008IDC-1.8#PBF	DFN	6	I	\$2.00		View
LT3008IDC-1.8#TRMPBF	DFN	6	I	\$2.00	\$1.45	View
LT3008IDC-1.8#TRPBF	DFN	6	I	\$2.00	\$1.40	View
LT3008IDC-2.5#PBF	DFN	6	I	\$2.00		View
LT3008IDC-2.5#TRMPBF	DFN	6	I	\$2.00	\$1.45	View
LT3008IDC-2.5#TRPBF	DFN	6	I	\$2.00	\$1.40	View
LT3008IDC-3.3#PBF	DFN	6	I	\$2.00		View
LT3008IDC-3.3#TRMPBF	DFN	6	I	\$2.00	\$1.45	View
LT3008IDC-3.3#TRPBF	DFN	6	I	\$2.00	\$1.40	View
LT3008IDC-5#PBF	DFN	6	I	\$2.00		View
LT3008IDC-5#TRMPBF	DFN	6	I	\$2.00	\$1.45	View
LT3008IDC-5#TRPBF	DFN	6	I	\$2.00	\$1.40	View
LT3008ITS8#PBF	SOT	8	I	\$2.00		View

LT3008ITS8#TRMPBF	SOT	8	I	\$2.00	\$1.45	View
LT3008ITS8#TRPBF	SOT	8	I	\$2.00	\$1.40	View
LT3008ITS8-1.2#PBF	SOT	8	I	\$2.00		View
LT3008ITS8-1.2#TRMPBF	SOT	8	I	\$2.00	\$1.45	View
LT3008ITS8-1.2#TRPBF	SOT	8	I	\$2.00	\$1.40	View
LT3008ITS8-1.5#PBF	SOT	8	I	\$2.00		View
LT3008ITS8-1.5#TRMPBF	SOT	8	I	\$2.00	\$1.45	View
LT3008ITS8-1.5#TRPBF	SOT	8	I	\$2.00	\$1.40	View
LT3008ITS8-1.8#PBF	SOT	8	I	\$2.00		View
LT3008ITS8-1.8#TRMPBF	SOT	8	I	\$2.00	\$1.45	View
LT3008ITS8-1.8#TRPBF	SOT	8	I	\$2.00	\$1.40	View
LT3008ITS8-2.5#PBF	SOT	8	I	\$2.00		View
LT3008ITS8-2.5#TRMPBF	SOT	8	I	\$2.00	\$1.45	View
LT3008ITS8-2.5#TRPBF	SOT	8	I	\$2.00	\$1.40	View
LT3008ITS8-3.3#PBF	SOT	8	I	\$2.00		View
LT3008ITS8-3.3#TRMPBF	SOT	8	I	\$2.00	\$1.45	View
LT3008ITS8-3.3#TRPBF	SOT	8	I	\$2.00	\$1.40	View
LT3008ITS8-5#PBF	SOT	8	I	\$2.00		View
LT3008ITS8-5#TRMPBF	SOT	8	I	\$2.00	\$1.45	View
LT3008ITS8-5#TRPBF	SOT	8	I	\$2.00	\$1.40	View
LT3008MPTS8#PBF	SOT	8	MP	\$5.40		View
LT3008MPTS8#TRMPBF	SOT	8	MP	\$5.40	\$3.83	View
LT3008MPTS8#TRPBF	SOT	8	MP	\$5.40	\$3.78	View
LT3008MPTS8-1.2#PBF	SOT	8	MP	\$5.40		View
LT3008MPTS8-1.2#TRMPBF	SOT	8	MP	\$5.40	\$3.83	View
LT3008MPTS8-1.2#TRPBF	SOT	8	MP	\$5.40	\$3.78	View
LT3008MPTS8-1.5#PBF	SOT	8	MP	\$5.40		View
LT3008MPTS8-1.5#TRMPBF	SOT	8	MP	\$5.40	\$3.83	View
LT3008MPTS8-1.5#TRPBF	SOT	8	MP	\$5.40	\$3.78	View

LT3008MPTS8-1.8#PBF	SOT	8	MP	\$5.40		View
LT3008MPTS8-1.8#TRMPBF	SOT	8	MP	\$5.40	\$3.83	View
LT3008MPTS8-1.8#TRPBF	SOT	8	MP	\$5.40	\$3.78	View
LT3008MPTS8-2.5#PBF	SOT	8	MP	\$5.40		View
LT3008MPTS8-2.5#TRMPBF	SOT	8	MP	\$5.40	\$3.83	View
LT3008MPTS8-2.5#TRPBF	SOT	8	MP	\$5.40	\$3.78	View
LT3008MPTS8-3.3#PBF	SOT	8	MP	\$5.40		View
LT3008MPTS8-3.3#TRMPBF	SOT	8	MP	\$5.40	\$3.83	View
LT3008MPTS8-3.3#TRPBF	SOT	8	MP	\$5.40	\$3.78	View
LT3008MPTS8-5#PBF	SOT	8	MP	\$5.40		View
LT3008MPTS8-5#TRMPBF	SOT	8	MP	\$5.40	\$3.83	View
LT3008MPTS8-5#TRPBF	SOT	8	MP	\$5.40	\$3.78	View
Buy Now						
Request Samples						

* The USA list pricing shown is for BUDGETARY USE ONLY, shown in United States dollars (FOB USA per unit for the stated volume), and is subject to change. International prices may differ due to local duties, taxes, fees and exchange rates. For volume-specific price or delivery quotes, please contact your local Linear Technology [sales office or authorized distributor](#).

Evaluation Kits

Part Number	Description	Price
DC1388A	LT3008EDC6 Demo Board 3uA Iq, 20mA Low Dropout Linear Regulators	\$75.00
Buy Now		

[Back to Top](#)

Applications

- Automotive
- Low Current Battery-Powered Systems
- Keep-Alive Power Supplies
- Remote Monitoring
- Utility Meters
- Low Power Industrial Applications

[Back to Top](#)

Simulate

LTSpice IV is a powerful FREE circuit simulator and schematic capture program, providing macro models for 80% of Linear Technology's switching regulators, over 200 op amp models, as well as resistors, transistors and MOSFET models.

- Step 1. If you do not already have a copy of LTSpice IV, click here to download and install [LTSpice / SwitcherCAD III](#)
- Step 2. Once LTSpice is installed, click here for a ready to run [demonstration circuit of the LT3008](#).
- Step 3. If LTSpice IV does not automatically open after clicking the above link, you can instead run the simulation by right clicking on the link and selecting "Save Target As". After saving the file to your computer, start LTSpice and open the demonstration circuit by selecting "Open" from the "File" menu.

For our complete list of hundreds of ready to run demo circuits, visit our [LTSpice IV Demo Circuits Collection](#)

[Back to Top](#)

Order Now

[Request Samples](#)

Documentation

Datasheet

- [LT3008 Series - 3•A IQ, 20mA, 45V Low Dropout Linear Regulators](#)

Reliability Data

- [R531 - Reliability Data](#)

Press Release

- [High Voltage, Low Dropout Linear Regulators Operate Down to -55°C](#)
- [Tiny, High Voltage LDO Has 3uA IQ](#)

Software and Simulation

- [LT3008 Demo Circuit](#)

- [Site Help](#)
- [Site Map](#)
- [Site Index](#)
- [Send Us Feedback](#)
- [■](#)

© 2007 Linear Technology | [Terms of Use](#) | [Privacy Policy](#)