

Data Sheet



Description

The AMMP-6630 MMIC is a monolithic, voltage variable, GaAs IC attenuator that operates from 5-30 GHz. It is fabricated using Avago Technologies enhancement mode MMIC process with backside ground vias, and gate lengths of approximately 0.25um. The attenuator has a distributed topology and it helps to absorb parasitic effects of its series and shunt FETs to make it broadband.

AMMP-6630 Pin Connections (Top View)

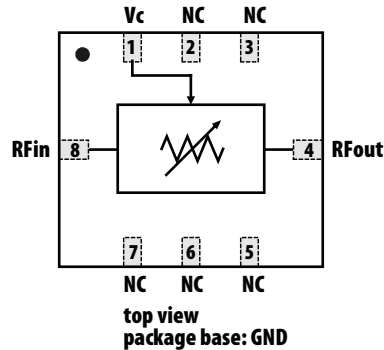

Pin	
1	Vc
4	RFout
8	RFin

Features

- Surface Mount Package, 5.0 x 5.0 x 2 mm
- Wide Frequency Range 5-30 GHz
- Attenuation Range 20dB
- Single Positive Bias Supply
- Unconditionally Stable

Applications

- Microwave Radio Systems
- Satellite VSAT, DBS Up / Down Link
- LMDS & Pt – Pt mmW Long Haul
- Broadband Wireless Access (including 802.16 and 802.20 WiMax)
- WLL and MMDS loops



Attention: Observe Precautions for handling electrostatic sensitive devices.
ESD Machine Model (Class A): 70V
ESD Human Body Model (Class 1A): 400V
Refer to Avago Application Note A004R: Electrostatic Discharge Damage and Control.

Table 1. AMMP-6630 Absolute Maximum Ratings^[1]

Symbol	Parameters and Test Conditions	Unit	Minimum	Maximum
V _C	Voltage to Control Attenuation	V	0	1.6
P _{in}	RF Input Power	dBm	-	27
T _{ch}	Operating Channel Temperature	°C	-	+150
T _{stg}	Storage Temperature	°C	-40	+150
T _{max}	Maximum Assembly Temperature	°C		+300 for 60s

Notes:

1. Operation in excess of any one of these conditions may result in permanent damage to this device. The absolute maximum ratings for V_C and P_{in} were determined at an ambient temperature of 25°C unless noted otherwise.

Table 2. AMMP-6630 DC Specifications^[1, 2]

Symbol	Parameters	Test Conditions	Unit	Min	Typical	Max
I _{C_ref}	V _C Control Current (Min Attenuation)	V _C = 0 V	μA	-	0	30
I _{C_ref}	V _C Control Current (Max Attenuation)	V _C = 1.0 V	μA	-	150	200

Notes:

1. Ambient operation temperature T_A = 25°C unless otherwise noted.
2. Data obtained from on-wafer measurements.

Table 3. AMMP-6630 RF Specifications^[1, 2]Small/Large-signal data measured on-wafer at T_A = 25°C, Z₀ = 50 Ω

Symbol	Parameters and Test Conditions	Units	Freq. [GHz]	Minimum	Typical	Maximum
Minimum Attenuation (Reference State)	Small-signal S21 V _C = 0 V	dB	7			5.0
			16			2.5
			25			3.5
			34			3.5
Maximum Attenuation	Small-signal S21 V _C = 1.0 V	dB	7	23.0		
			16	22.0		
			25	22.5		
			34	23.5		
RL _{in} and RL _{out} at Reference State	V _C = 0 V	dB	<45		10	
RL _{in} and RL _{out} at Maximum State	V _C = 1.0 V	dB	<45		10	

Notes:

1. All tested parameters guaranteed with measurement accuracy ±2.5dB for Min Attenuation of 7GHz, ±1 for Min Attenuation of 16,25GHz &34GHz, ±3 for Max Attenuation of 7GHz, and ±2 for Max Attenuation of 16GHz, 25GHz &34GHz.

Typical Distribution Charts

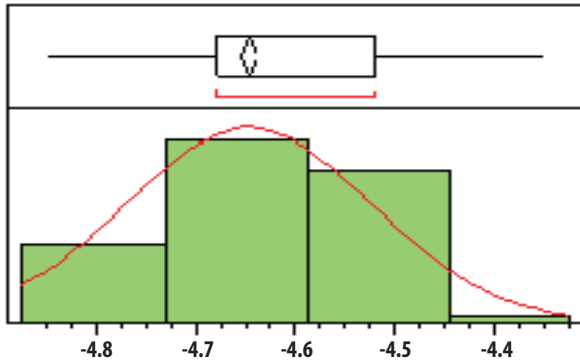

Figure 1. Min Attenuation @ 7GHz, Nominal=-4.6, LSL=-5.0

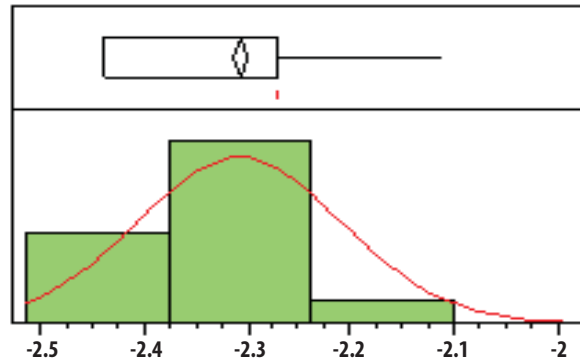

Figure 2. Min Attenuation @ 16GHz, Nominal=-2.3, LSL=-2.5

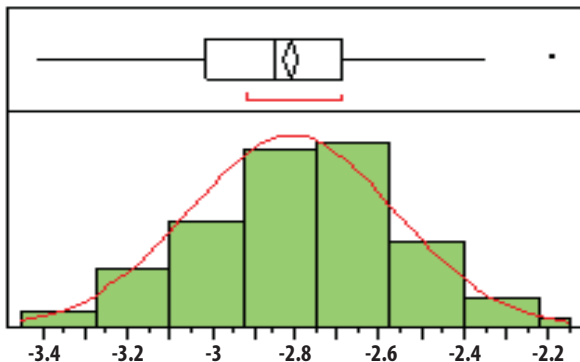

Figure 3. Min Attenuation @ 25GHz, Nominal=-2.8, LSL=-3.5

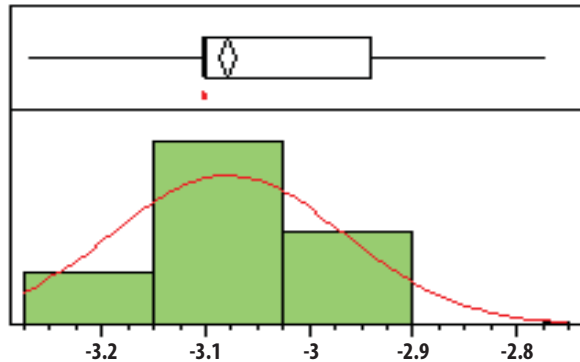

Figure 4. Min Attenuation @ 34 GHz, Nominal=-3.07, LSL=-3.5

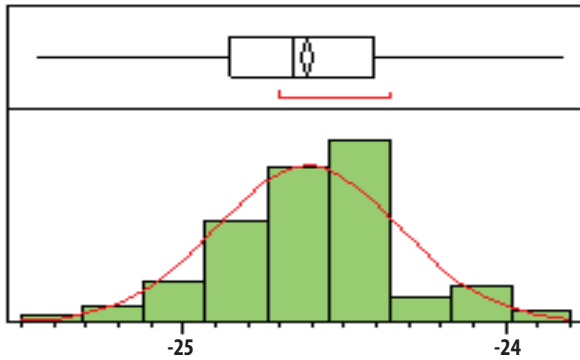

Figure 5. Max Attenuation @ 7GHz, Nominal=-24.6, USL=-23.0

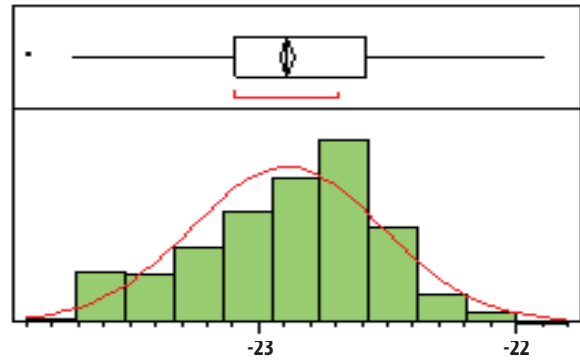

Figure 6. Max Attenuation @ 16GHz, Nominal=-22.8, USL=-22.0

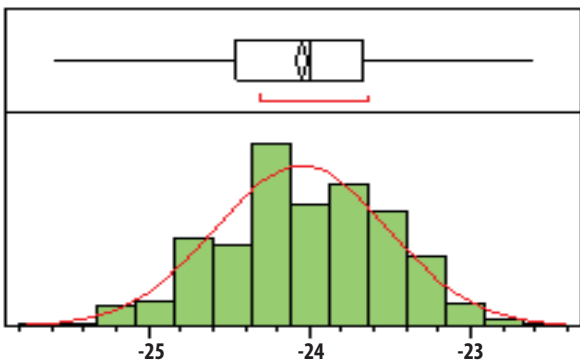

Figure 7. Max Attenuation @ 25GHz, Nominal=-24, USL=-22.5

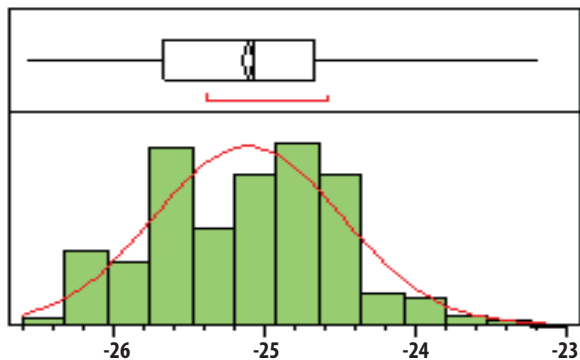

Figure 8. Max Attenuation @ 34GHz, Nominal=-25.1, USL=-23.5

Notes:

1. Attenuation is a positive number; whereas, S21 as measured on a Network Analyzer is a negative number.

AMMP-6630 Typical Performance ($T_A = 25^\circ\text{C}$, $Z_{in} = Z_{out} = 50 \Omega$)

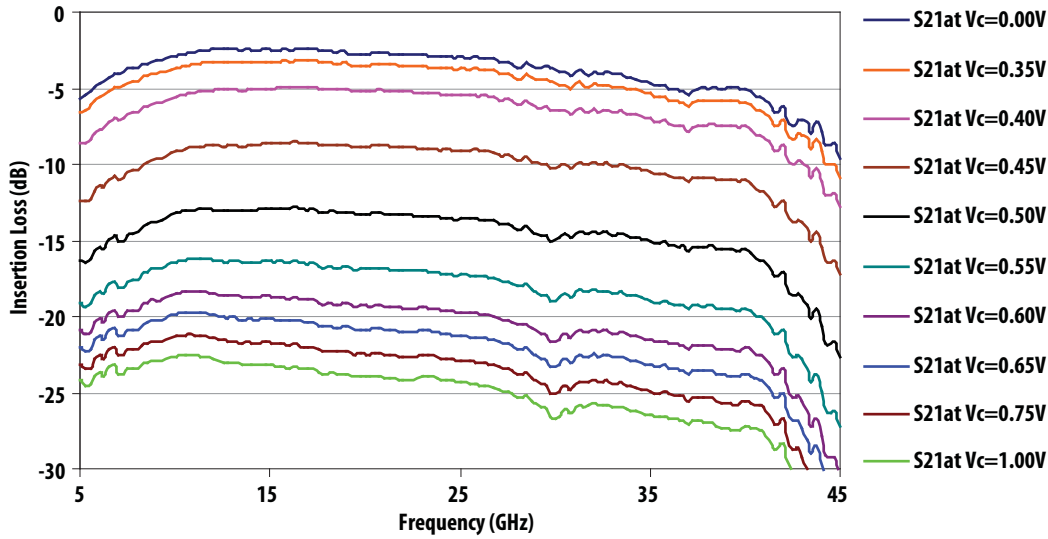

Figure 9. Insertion Loss vs Frequency

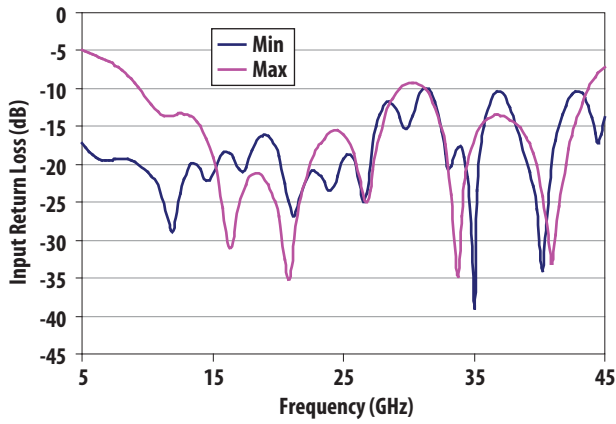

Figure 10. Output Return Loss vs Frequency at Min Attenuation

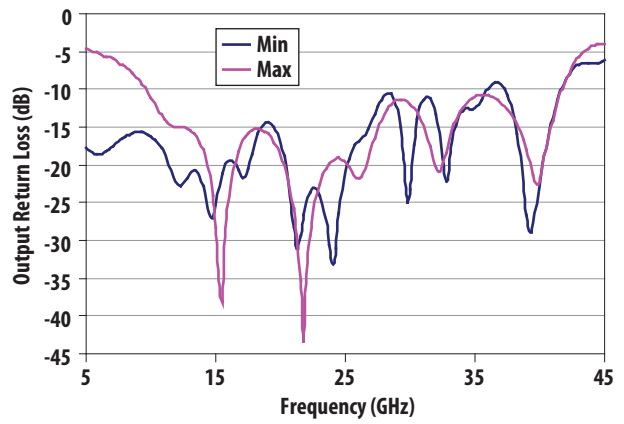

Figure 11. Input Return Loss vs Frequency at Max Attenuation

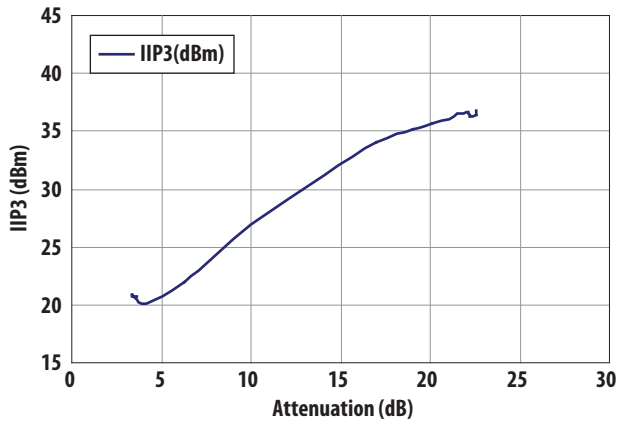

Figure 12a. IIP3 vs Attenuation (Frequency = 7 GHz, Input Power = -10dBm)

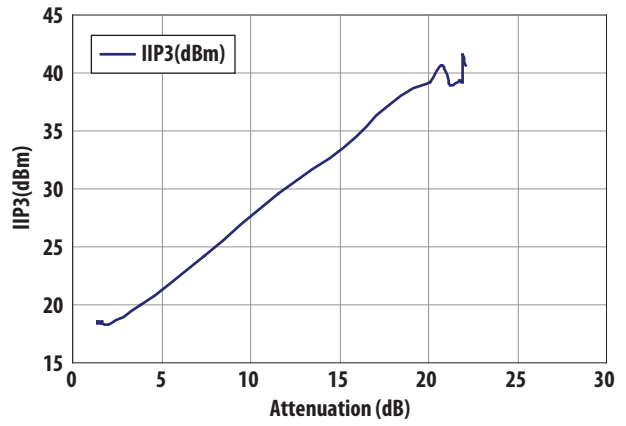

Figure 12b. IIP3 vs Attenuation (Frequency = 16 GHz, Input Power = -10dBm)

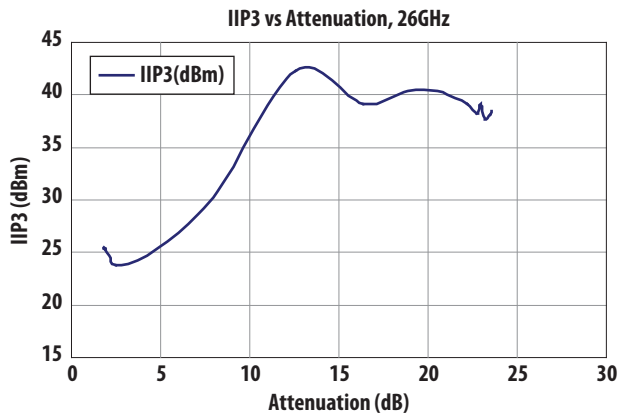

Figure 12c. IIP3 vs Attenuation (Frequency = 25 GHz, Input Power = -10dBm)

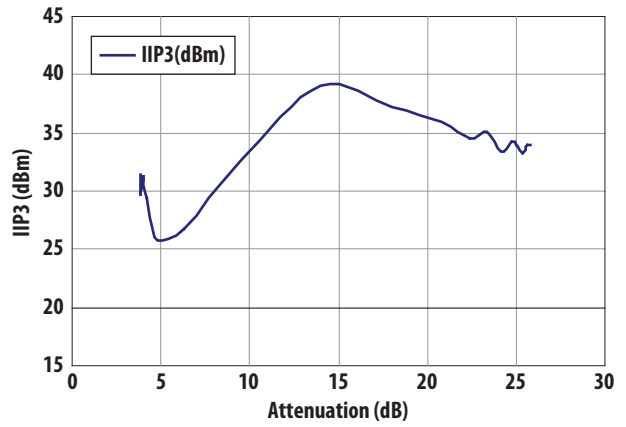

Figure 12d. IIP3 vs Attenuation (Frequency = 34 GHz, Input Power = -13dBm)

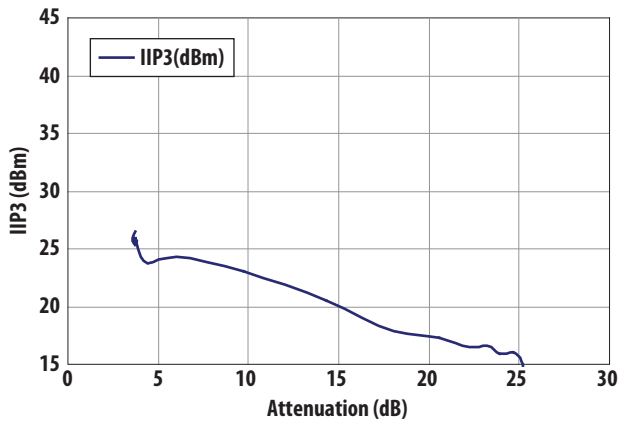

Figure 12e. IIP3 vs Attenuation (Frequency = 42 GHz, Input Power = -16dBm)

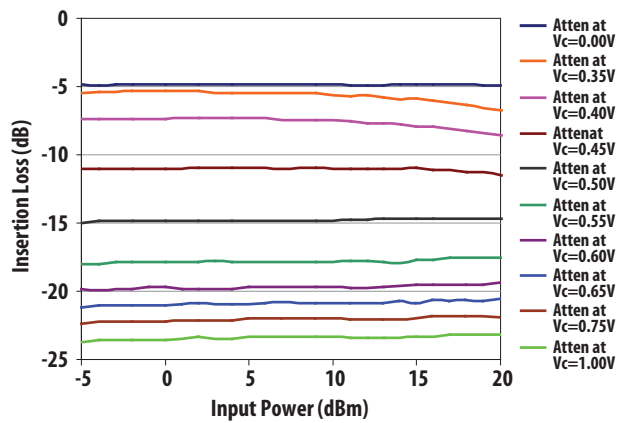

Figure 13a. Attenuation vs Input Power (Frequency = 7 GHz)

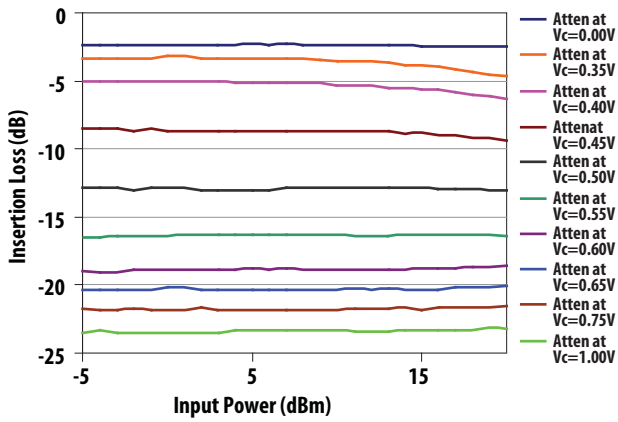

Figure 13b. Attenuation vs Input Power (Frequency = 16 GHz)

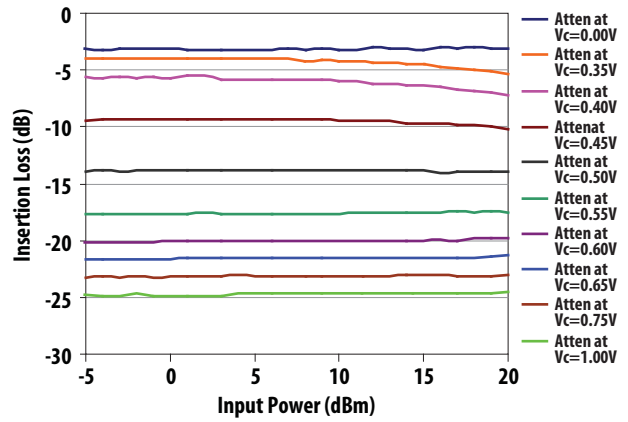

Figure 13c. Attenuation vs Input Power (Frequency = 25 GHz)

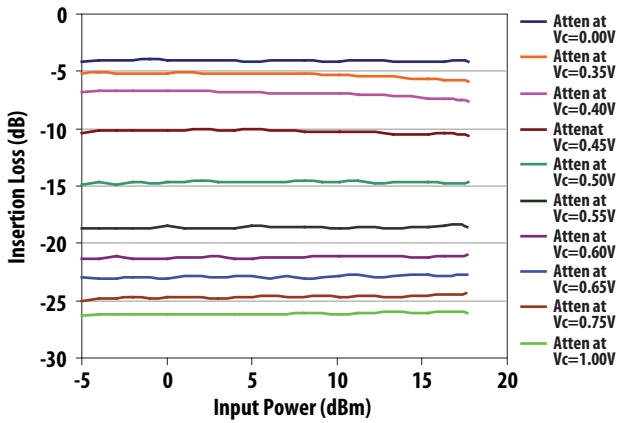

Figure 13d. Attenuation vs Input Power (Frequency = 34 GHz)

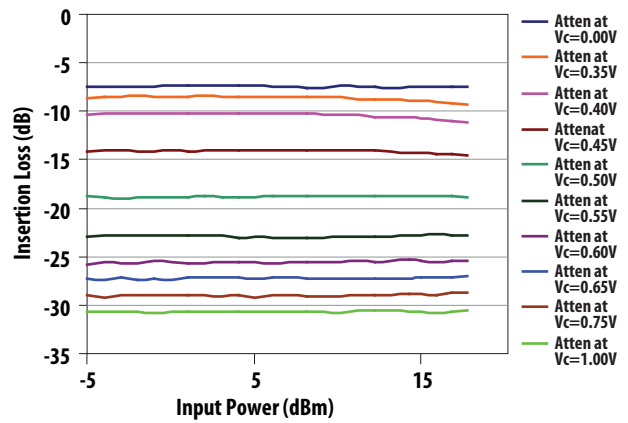

Figure 13e. Attenuation vs Input Power (Frequency = 42 GHz)

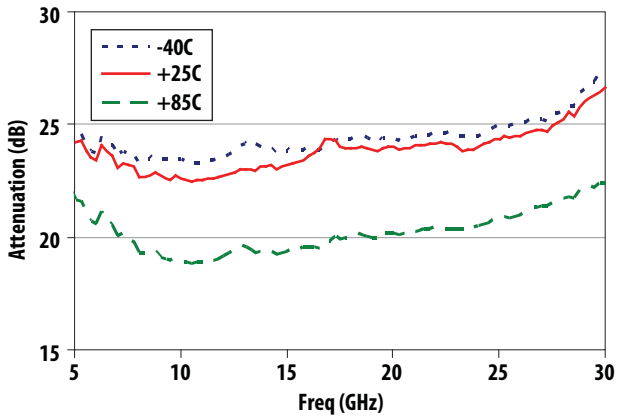

Figure 14. Attenuation vs Frequency (Max Attenuation)

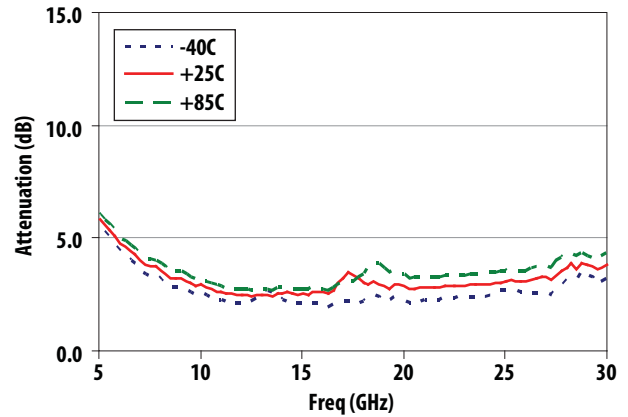

Figure 15. Attenuation vs Frequency (Min Attenuation)

Notes for Figure 12 ~ 13:

1. Attenuation is a positive number, whereas insertion loss S_{21} measured on a network analyzer is a negative number.

AMMP-6630 Typical Scattering Parameters at Min Attenuation ($T_c = 25^\circ\text{C}$, $Z_0 = 50\text{ohm}$, $V_C = 0\text{V}$)

Freq GHz	S11			S21			S12			S22		
	dB	Mag	Phase	dB	Mag	Phase	dB	Mag	Phase	dB	Mag	Phase
1.0	-25	0.0541	127.0	-18.2	0.1225	4.2	-18.2	0.1224	4.2	-25.4	0.0536	128.0
2.0	-19	0.1078	48.9	-12.6	0.2351	-79.2	-12.6	0.2353	-79.1	-20.0	0.1005	48.6
3.0	-16	0.1500	-28.6	-9.4	0.3388	-162.0	-9.4	0.3408	-162.1	-17.3	0.1359	-30.8
4.0	-16	0.1597	-109.1	-7.3	0.4325	115.4	-7.2	0.4340	115.0	-16.8	0.1453	-113.6
5.0	-17	0.1377	159.6	-5.8	0.5151	32.9	-5.8	0.5133	32.2	-17.7	0.1296	152.2
6.0	-19	0.1120	53.4	-4.8	0.5779	-49.7	-4.8	0.5725	-49.5	-18.6	0.1180	44.3
7.0	-19	0.1069	-54.9	-4.0	0.6306	-132.5	-4.0	0.6297	-131.5	-17.6	0.1316	-63.5
8.0	-19	0.1095	-151.8	-3.6	0.6569	146.1	-3.5	0.6697	146.7	-16.2	0.1546	-160.1
9.0	-20	0.1034	124.6	-3.2	0.6920	65.6	-3.1	0.6999	65.7	-15.7	0.1639	112.7
10.0	-21	0.0892	52.2	-2.9	0.7134	-14.5	-2.9	0.7196	-14.7	-16.2	0.1552	31.2
11.0	-24	0.0659	-26.5	-2.6	0.7397	-94.8	-2.6	0.7392	-94.9	-18.4	0.1208	-55.8
12.0	-29	0.0368	179.7	-2.5	0.7538	-175.3	-2.5	0.7530	-175.3	-22.5	0.0751	-176.9
13.0	-21	0.0902	37.4	-2.4	0.7547	104.6	-2.5	0.7533	104.7	-21.1	0.0876	44.1
14.0	-21	0.0940	-45.0	-2.5	0.7516	25.2	-2.5	0.7505	25.6	-22.6	0.0738	-45.0
15.0	-21	0.0860	-80.4	-2.5	0.7495	-54.6	-2.5	0.7471	-54.0	-25.4	0.0537	-44.2
16.0	-18	0.1199	-153.4	-2.5	0.7517	-133.8	-2.5	0.7507	-132.4	-19.6	0.1052	-93.2
17.0	-21	0.0937	79.7	-2.5	0.7530	146.4	-2.4	0.7597	147.1	-21.5	0.0843	-140.0
18.0	-18	0.1217	-81.2	-2.5	0.7464	66.8	-2.7	0.7322	66.8	-17.3	0.1370	-162.3
19.0	-16	0.1566	165.9	-2.6	0.7419	-11.8	-2.9	0.7143	-10.6	-14.4	0.1904	121.6
20.0	-19	0.1156	73.9	-2.8	0.7270	-89.2	-2.8	0.7279	-88.2	-17.0	0.1420	35.9
21.0	-26	0.0483	29.3	-2.7	0.7317	-168.2	-2.7	0.7289	-167.8	-27.7	0.0410	-22.0
22.0	-23	0.0743	15.4	-2.8	0.7270	112.6	-2.8	0.7237	112.6	-25.0	0.0562	0.0
23.0	-21	0.0881	-48.6	-2.8	0.7207	33.3	-2.9	0.7194	33.2	-24.0	0.0633	-63.2
24.0	-23	0.0672	-84.9	-2.9	0.7122	-46.3	-3.0	0.7116	-46.6	-32.9	0.0228	-71.6
25.0	-19	0.1082	-120.1	-3.0	0.7115	-126.2	-3.0	0.7052	-126.5	-21.1	0.0881	-55.4
26.0	-20	0.0956	150.0	-3.0	0.7055	154.1	-3.2	0.6957	154.2	-16.9	0.1434	-108.3
27.0	-20	0.0952	-46.9	-3.3	0.6840	73.2	-3.2	0.6904	73.7	-14.4	0.1915	-143.0
28.0	-12	0.2392	-152.7	-3.6	0.6597	-5.7	-3.5	0.6715	-6.0	-10.8	0.2882	163.0
29.0	-13	0.2329	134.5	-3.7	0.6551	-85.6	-3.8	0.6422	-85.4	-12.6	0.2343	91.6
30.0	-15	0.1802	114.6	-3.8	0.6478	-166.2	-3.9	0.6407	-167.4	-23.3	0.0680	125.3
31.0	-10	0.3054	72.1	-4.0	0.6281	114.4	-3.9	0.6399	111.2	-11.4	0.2698	78.3
32.0	-12	0.2628	1.2	-3.9	0.6393	35.0	-3.8	0.6429	35.0	-13.3	0.2159	5.1
33.0	-20	0.0952	-24.6	-4.1	0.6253	-46.6	-4.1	0.6271	-46.7	-20.2	0.0977	26.3
34.0	-18	0.1280	-43.6	-4.3	0.6070	-129.4	-4.4	0.6012	-129.2	-12.8	0.2280	-11.0
35.0	-38	0.0127	84.2	-4.7	0.5832	149.5	-4.7	0.5852	149.5	-12.5	0.2371	-54.9
36.0	-13	0.2254	-23.2	-5.0	0.5629	68.5	-5.1	0.5560	68.3	-10.0	0.3176	-99.0
37.0	-10	0.3024	-105.2	-5.5	0.5328	-11.3	-5.2	0.5494	-12.5	-9.3	0.3416	-170.8
38.0	-14	0.2080	-176.6	-5.0	0.5592	-94.5	-4.8	0.5738	-94.0	-13.7	0.2068	103.2
39.0	-19	0.1059	138.3	-5.0	0.5649	-177.2	-4.8	0.5744	-178.8	-26.4	0.0477	-12.5
40.0	-30	0.0321	108.1	-5.0	0.5607	95.5	-5.1	0.5544	95.8	-22.8	0.0728	-160.4
41.0	-19	0.1079	157.4	-5.6	0.5223	9.8	-5.7	0.5188	9.5	-13.9	0.2025	136.1
42.0	-12	0.2414	73.1	-6.2	0.4887	-76.0	-6.6	0.4664	-76.1	-8.8	0.3626	60.0
43.0	-10	0.3024	-18.0	-7.1	0.4402	-159.8	-7.8	0.4076	-160.2	-6.7	0.4607	-14.2
44.0	-14	0.2034	-94.3	-7.9	0.4032	117.9	-8.3	0.3842	114.5	-6.6	0.4686	-74.7
45.0	-14	0.2041	-94.5	-9.6	0.3330	25.5	-9.3	0.3446	24.3	-6.2	0.4907	-121.9
46.0	-9	0.3507	-159.8	-10.5	0.2981	-60.7	-10.5	0.2973	-61.0	-6.4	0.4811	-175.7
47.0	-13	0.2222	115.1	-10.8	0.2872	-154.1	-10.9	0.2862	-154.3	-11.9	0.2537	144.1
48.0	-22	0.0779	-88.7	-14.3	0.1919	96.4	-14.2	0.1957	97.0	-7.0	0.4455	154.9
49.0	-9	0.3466	-173.4	-24.6	0.0587	0.3	-22.6	0.0742	2.1	-3.1	0.7029	87.6
50.0	-6	0.5206	120.0	-32.1	0.0247	11.8	-31.7	0.0259	9.6	-3.3	0.6857	7.4

Note : S-parameters are obtained from on-wafer measurements.

AMMC-6630 Typical Scattering Parameters^[1] at Max Attenuation (Tc = 25°C, Zo = 50ohm, Vc = 1.0V)

Freq GHz	S11			S21			S12			S22		
	dB	Mag	Phase	dB	Mag	Phase	dB	Mag	Phase	dB	Mag	Phase
1.0	-1.9	0.8021	83.3	-37.1	0.0139	5.4	-37.1	0.0140	5.6	-1.9	0.8052	82.9
2.0	-2.1	0.7861	-9.0	-31.2	0.0276	-75.6	-31.0	0.0282	-75.7	-2.1	0.7888	-10.9
3.0	-2.6	0.7376	-101.8	-27.6	0.0417	-160.7	-27.7	0.0414	-162.4	-2.6	0.7416	-105.5
4.0	-3.7	0.6513	161.9	-25.5	0.0533	113.0	-25.8	0.0515	112.0	-3.6	0.6610	157.2
5.0	-4.8	0.5748	62.6	-24.3	0.0613	26.5	-24.7	0.0581	27.6	-4.6	0.5911	58.0
6.0	-5.6	0.5245	-35.7	-23.7	0.0654	-56.0	-23.6	0.0664	-53.7	-5.3	0.5453	-40.0
7.0	-6.4	0.4790	-131.1	-23.7	0.0656	-140.5	-23.1	0.0699	-139.5	-6.0	0.5034	-134.9
8.0	-7.5	0.4210	135.6	-23.4	0.0673	139.9	-23.0	0.0705	137.0	-7.0	0.4470	132.9
9.0	-9.2	0.3469	42.5	-22.9	0.0713	56.0	-22.8	0.0721	54.1	-8.6	0.3716	42.0
10.0	-11.4	0.2677	-54.5	-22.6	0.0740	-26.9	-22.7	0.0733	-27.7	-11.0	0.2803	-51.4
11.0	-13.3	0.2151	-160.0	-22.6	0.0744	-111.4	-22.6	0.0742	-111.3	-13.9	0.2023	-154.4
12.0	-13.5	0.2103	96.5	-22.8	0.0726	165.2	-22.8	0.0727	165.3	-15.1	0.1765	98.0
13.0	-13.4	0.2137	6.6	-23.0	0.0707	84.0	-23.0	0.0704	84.2	-15.4	0.1697	4.0
14.0	-14.8	0.1819	-74.2	-23.1	0.0697	3.0	-23.1	0.0701	3.7	-17.9	0.1271	-75.6
15.0	-19.0	0.1126	-153.6	-23.2	0.0695	-79.3	-23.1	0.0699	-78.8	-27.7	0.0413	-145.8
16.0	-28.4	0.0380	100.8	-23.4	0.0679	-161.2	-23.3	0.0680	-161.1	-24.8	0.0578	-46.0
17.0	-25.6	0.0522	-71.7	-23.5	0.0670	116.8	-23.6	0.0658	117.7	-17.3	0.1370	-113.3
18.0	-21.4	0.0850	-158.5	-23.8	0.0648	36.8	-23.9	0.0637	38.2	-15.3	0.1725	178.1
19.0	-22.0	0.0793	127.7	-23.8	0.0647	-42.3	-24.0	0.0633	-40.9	-15.9	0.1610	108.6
20.0	-26.6	0.0468	62.2	-24.0	0.0634	-120.7	-24.0	0.0635	-120.1	-18.7	0.1165	37.7
21.0	-33.7	0.0206	85.5	-24.0	0.0631	160.0	-24.1	0.0627	160.3	-25.6	0.0526	-30.2
22.0	-22.6	0.0743	56.4	-24.1	0.0621	81.4	-24.2	0.0619	81.4	-35.3	0.0172	43.3
23.0	-17.9	0.1269	-10.5	-24.0	0.0631	2.9	-24.0	0.0630	2.8	-22.7	0.0736	-3.1
24.0	-15.8	0.1624	-77.8	-24.1	0.0623	-79.5	-24.1	0.0624	-79.8	-19.4	0.1067	-59.9
25.0	-16.0	0.1594	-148.4	-24.3	0.0609	-159.7	-24.4	0.0601	-159.9	-19.7	0.1038	-110.1
26.0	-19.8	0.1019	131.5	-24.5	0.0596	120.2	-24.6	0.0590	120.6	-21.8	0.0813	-130.9
27.0	-23.6	0.0658	-19.7	-24.8	0.0577	39.4	-24.7	0.0580	39.9	-17.9	0.1280	-136.6
28.0	-14.7	0.1844	-124.1	-25.3	0.0546	-41.1	-25.1	0.0553	-40.9	-13.4	0.2141	-177.2
29.0	-10.6	0.2936	167.9	-25.7	0.0519	-122.1	-25.9	0.0506	-122.8	-11.5	0.2654	132.2
30.0	-9.3	0.3428	108.2	-26.7	0.0464	162.3	-26.8	0.0455	159.4	-12.0	0.2512	82.0
31.0	-9.7	0.3287	50.2	-26.2	0.0489	86.2	-26.2	0.0491	82.9	-14.7	0.1839	36.1
32.0	-12.4	0.2401	-7.3	-25.7	0.0517	5.4	-25.6	0.0526	4.8	-20.3	0.0967	20.6
33.0	-19.9	0.1008	-60.7	-26.0	0.0504	-76.9	-25.9	0.0507	-76.9	-16.8	0.1451	32.4
34.0	-27.1	0.0443	31.9	-26.2	0.0492	-159.8	-26.2	0.0490	-159.6	-12.6	0.2351	-7.7
35.0	-16.6	0.1473	-6.5	-26.5	0.0473	119.1	-26.5	0.0473	118.9	-11.0	0.2808	-57.7
36.0	-14.0	0.1992	-58.0	-26.7	0.0464	38.1	-26.8	0.0458	38.1	-10.8	0.2868	-109.9
37.0	-13.5	0.2103	-108.2	-27.1	0.0441	-43.1	-26.9	0.0452	-43.5	-11.8	0.2574	-163.9
38.0	-14.4	0.1914	-158.0	-26.9	0.0451	-125.2	-26.8	0.0455	-124.7	-13.9	0.2027	136.6
39.0	-16.4	0.1510	148.4	-27.4	0.0427	154.7	-27.2	0.0437	153.7	-17.9	0.1280	62.2
40.0	-21.6	0.0831	90.0	-27.3	0.0434	74.4	-27.5	0.0423	73.6	-22.2	0.0777	-81.0
41.0	-33.0	0.0225	108.0	-27.6	0.0418	-13.0	-27.6	0.0418	-14.0	-14.2	0.1956	157.5
42.0	-20.1	0.0990	103.9	-28.4	0.0382	-100.6	-28.8	0.0362	-101.7	-8.9	0.3582	74.7
43.0	-13.2	0.2190	32.2	-30.9	0.0284	170.2	-31.5	0.0265	168.1	-5.8	0.5132	-0.4
44.0	-9.2	0.3476	-41.7	-33.7	0.0207	92.2	-34.2	0.0194	86.5	-4.3	0.6102	-68.2
45.0	-7.2	0.4361	-112.9	-37.0	0.0140	6.9	-36.8	0.0145	4.3	-4.1	0.6260	-130.8
46.0	-7.4	0.4262	175.2	-36.3	0.0153	-46.5	-36.4	0.0152	-46.4	-6.1	0.4936	165.7
47.0	-11.6	0.2645	85.0	-31.0	0.0283	-146.1	-30.9	0.0286	-146.6	-19.9	0.1013	139.3
48.0	-13.1	0.2221	-76.2	-32.7	0.0232	96.3	-32.5	0.0238	97.4	-5.7	0.5185	161.3
49.0	-6.8	0.4567	-175.4	-42.0	0.0079	12.0	-39.9	0.0101	12.5	-2.8	0.7272	87.9
50.0	-4.7	0.5830	116.7	-42.9	0.0072	18.6	-42.3	0.0077	18.8	-3.3	0.6827	7.8

Note : S-parameters are obtained from on-wafer measurements.

AMMP-6630 Bias and Usage

The recommended DC control voltage range is $V_c=0$ to 1 volt. A simplified schematic for the MMIC die in the package is shown in Figure 16.

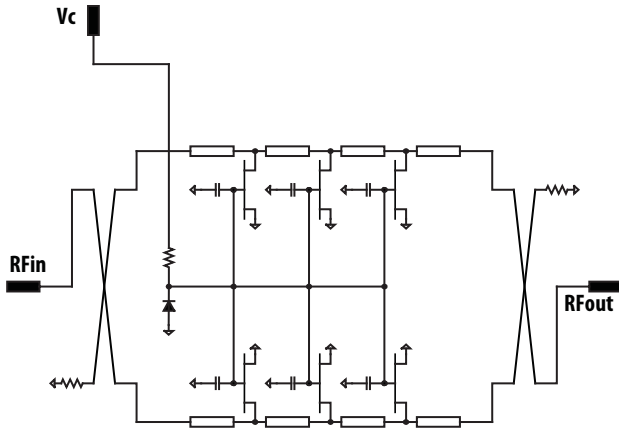

Figure 16. Simplified schematic

Stencil Design Guidelines

A properly designed solder screen or stencil is required to ensure optimum amount of solder paste is deposited onto the PCB pads. The recommended stencil layout is shown in Figure 18. The stencil has a solder paste deposition opening approximately 70% to 90% of the PCB pad. Reducing stencil opening can potentially generate more voids underneath.

On the other hand, stencil openings larger than 100% will lead to excessive solder paste smear or bridging across the I/O pads.

Considering the fact that solder paste thickness will directly affect the quality of the solder joint, a good choice is to use a laser cut stencil composed of 0.127 mm (5 mils) thick stainless steel which is capable of producing the required fine stencil outline.

Recommended PCB Land Pattern for Rogers R04350 is shown in Figure 19.

The combined PCB and stencil layout is shown in Figure 20.

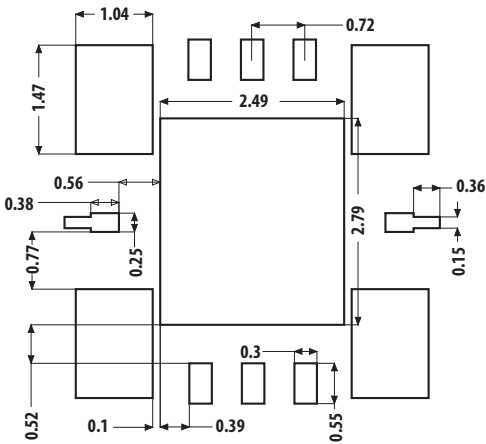

Figure 18. Stencil Outline Drawing (mm).

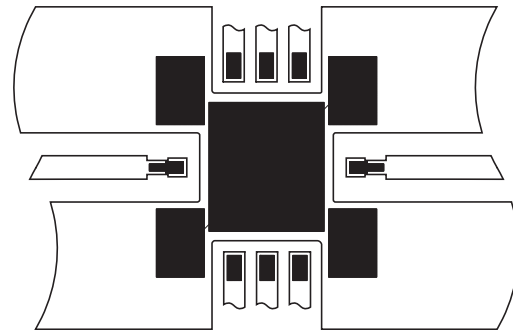

Figure 20. Combined PCB and Stencil Layouts

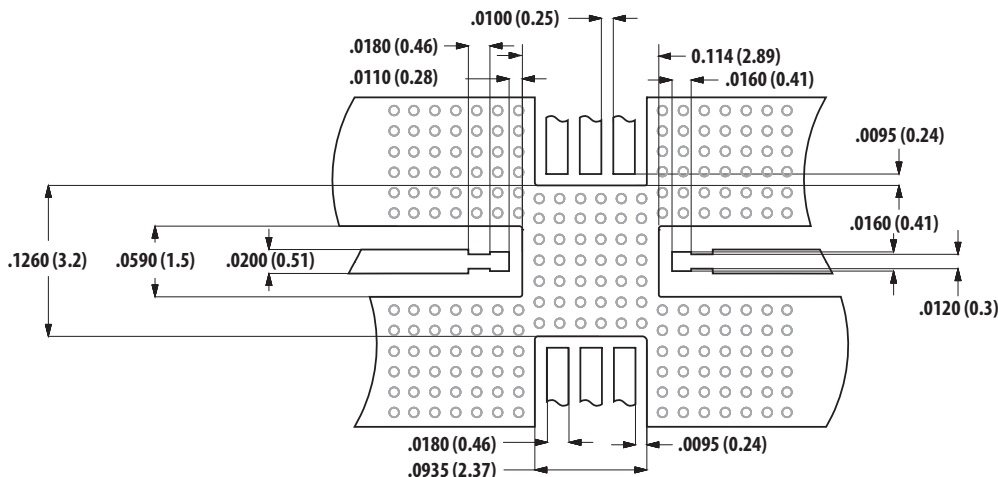

Figure 19. Recommended PCB Land Pattern for Rogers R04350, 0.010" thick. Dimensions are in inches [mm].

Recommended SMT Attachment

The AMMP Packaged Devices are compatible with high volume surface mount PCB assembly processes.

The PCB material and mounting pattern, as defined in Figure 20, optimizes RF performance and is strongly recommended. An electronic drawing of the land pattern is available upon request from Avago Sales & Application Engineering. For further assembly information please Avago application note# 5386.

Manual Assembly

1. Follow ESD precautions while handling packages.
2. Handling should be along the edges with tweezers.
3. Recommended attachment is conductive solder paste. Please see recommended solder reflow profile. Conductive epoxy is not recommended. Hand soldering is not recommended.
4. Apply solder paste using a stencil printer or dot placement. The volume of solder paste will be dependent on PCB and component layout and should be controlled to ensure consistent mechanical and electrical performance.
5. Follow solder paste and vendor's recommendations when developing a solder reflow profile. A standard profile will have a steady ramp up from room temperature to the pre-heat temperature to avoid damage due to thermal shock.
6. Packages have been qualified to withstand a peak temperature of 260°C for 20 seconds. Verify that the profile will not expose device beyond this limit.

Solder Reflow Profile

A commonly used solder reflow method is accomplished in a belt furnace using convection heat. The suggested reflow profile is in Figure 19. This profile will vary among different solder pastes from different manufacturers and is shown here for reference only.

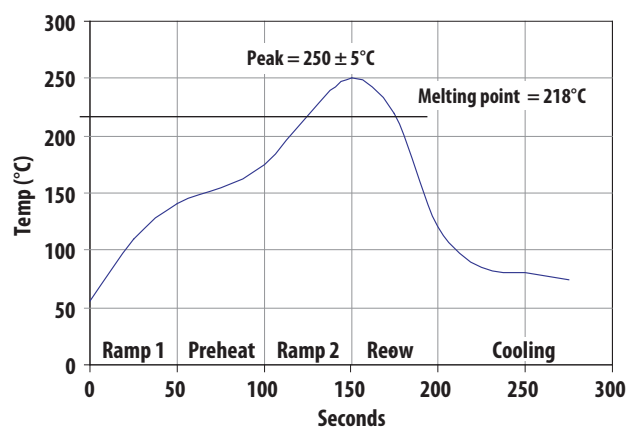
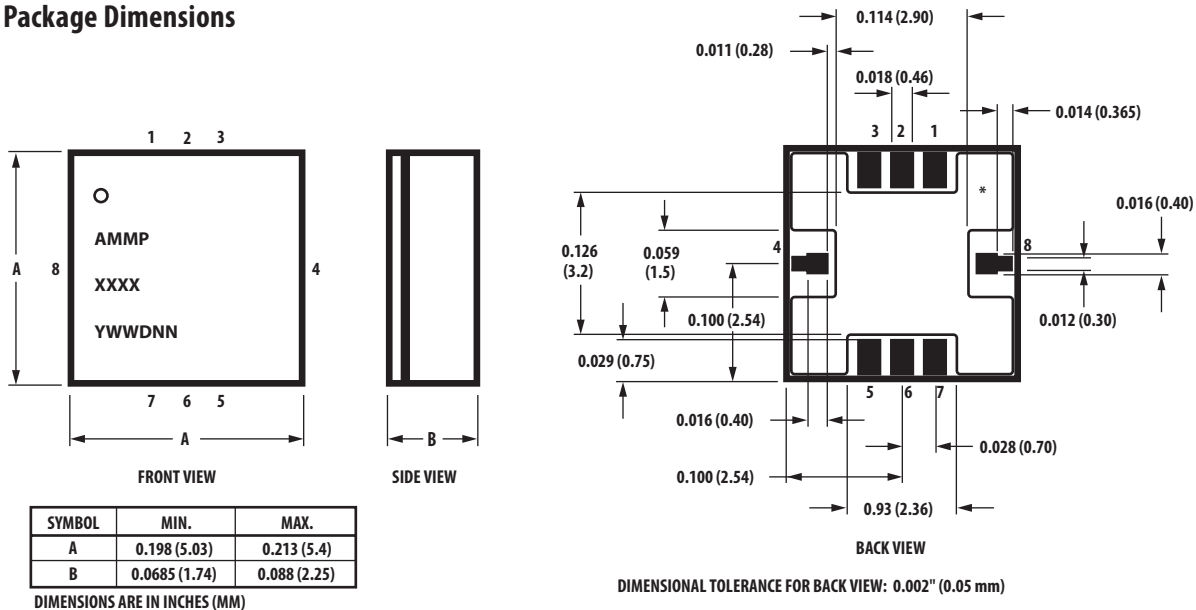

Figure 17. Suggested lead free reflow profile for SnAgCu Solder paste

Ordering Information

Part Number	Devices Per Container	Container
AMMP-6630-BLKG	10	Antistatic bag
AMMP-6630-TR1G	100	7" Reel
AMMP-6630-TR2G	500	7" Reel

Package Dimensions



NOTES:

- * INDICATES PIN 1
- DIMENSIONS ARE IN INCHES (MILLIMETERS)
- ALL GROUNDS MUST BE SOLDERED TO PCB RF GROUND

Tape Dimensions

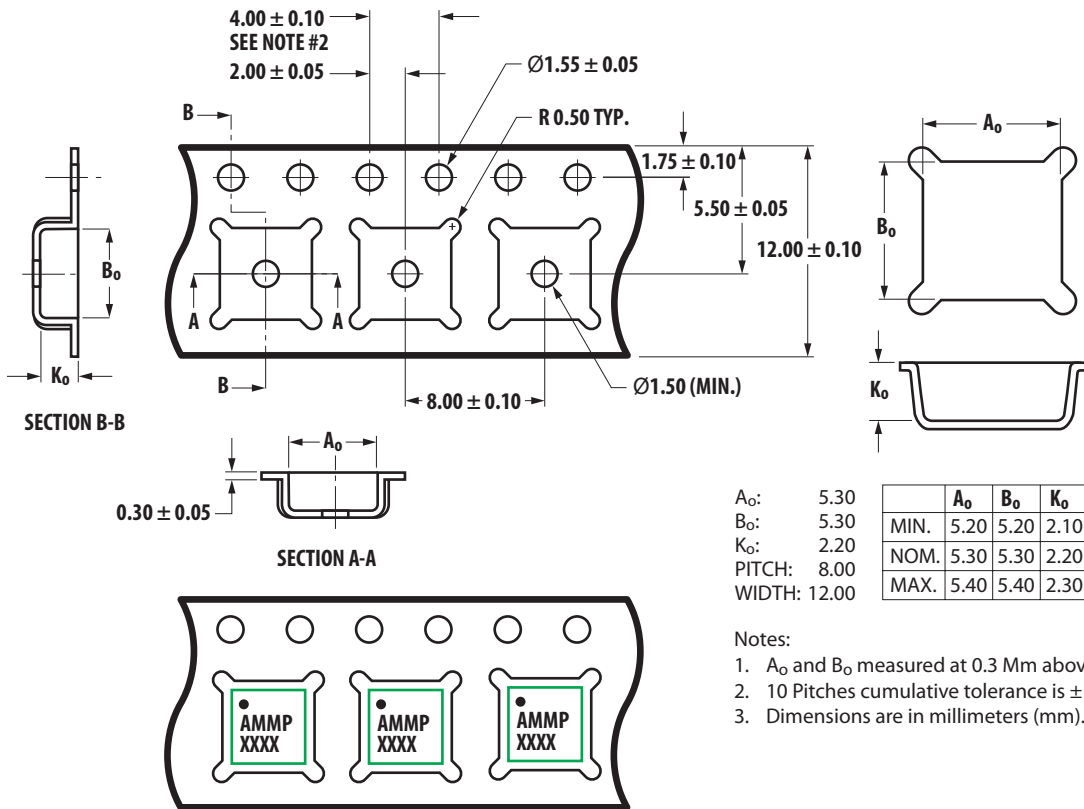

For product information and a complete list of distributors, please go to our web site: www.avagotech.com

Avago, Avago Technologies, and the A logo are trademarks of Avago Technologies in the United States and other countries. Data subject to change. Copyright © 2005-2010 Avago Technologies. All rights reserved. AV02-1753EN - September 9, 2010

AVAGO
TECHNOLOGIES