

Single Slot SMT Connectors For Card-Bus Based PC Cards

IC11S Series

PC Card Standard Compliant

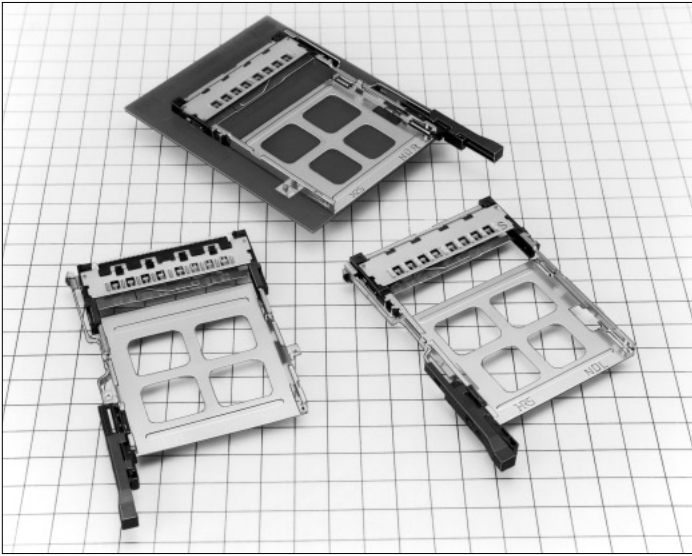

■ Features

1. PC Card Standard compliant

- Grounding is required to meet the high speed signal requirements of the PC card standard. Grounding reliability is achieved with a grounding plate and 8 grounding contacts.
- Type I , type II and type III cards are covered.
- Terminals for ground clipping are provided.

2. Reduced pattern-inhibited area

Pattern-inhibited area is reduced, compared to our conventional product. In addition, in comparison with Version 1, Pop-Up Version 2 has a reduced pattern prohibited area.

3. Reduced Height

Connector height is minimized to 5.6mm, making possible thinner product designs.

4. Eject mechanism with high-level functionality

Hirose Electric's original ejection mechanism provides an higher degree of card ejection over existing products. This improves the operational qualities of card removal. (Patents pending)

5. Wide Variety of Options Available

- Standard type mounts to the top of the PC board and reverse type mounts on the underside of the board
- Three types of eject buttons; rigid, flexible and POP-UP. All types can be installed on the right or left side of the ejector.
- Available with standoff to utilize space under the connector for mounting other parts.

6. Light-Weight

Compared to conventional type, it only weighs 12.7g for standard type (Rigid button, Standoff 0mm). Also, in comparison with Version 1, Pop-Up Version 2 has been made approximately 12% lighter.

Reduced height : 5.6mm high



Wide variety of options

- (1) Board Mounting
 - ① Standard type
 - ② Reverse type
- (2) Eject button type
 - ① Rigid button
 - ② Foldering button
 - ③ Pop-up (Version 1, 2) button
- (3) Position of eject buttons
 - ① Right
 - ② Left
- (4) Standoffs
 - ① 0mm
 - ② 2.2mm



Standard type



Reverse type

Product Specifications

Ratings	Current rating	0.5A	Operating temperature	-55°C to +85°C(Note.1)	Storage temperature	-40°C to +70°C(Note.2)
	Voltage rating	125V AC	Operating humidity	Relative humidity 95% max. (No condensation)	Storage humidity	40% to 70%(Note.2)

Item	Specification	Conditions
1.Insulation resistance	1000M ohms min.	500V DC
2.Withstanding voltage	No flashover or insulation breakdown.	500V AC
3.Contact resistance	60m ohms max. (initial value)	1mA
4.Vibration	No electrical discontinuity of 100ns or more	Frequency: 10 to 2000 Hz, full amplitude of 1.52 mm or acceleration of 147 m/s ² (peak), 4 hours in each of the 3 directions.
5.Humidity (Steady state)	Insulation resistance: 100M ohms min.	96 hours at temperature of 40°C and humidity of 90% to 95%
6.Temperature cycle	Insulation resistance: 100M ohms min.	Temperature: -55°C → +5°C to +35°C → +85°C → +5°C to +35°C Duration: 30 --> 5 max. --> 30 --> 5 max. (Minutes) 5 cycles
7.Durability (Insertion/withdrawal)	Variations from initial contact resistance: 20m ohms max.	10000 cycles at 400 to 600 cycles per hour
8.Resistance to Soldering heat	No deformation of components affecting performance.	Reflow: At the recommended temperature profile Manual soldering: 300°C for 3 seconds

Note 1: Includes temperature rise caused by current flow.

Note 2: The term "storage" refers to products stored for long period of time prior to mounting and use. Operating Temperature Range and Humidity range covers non- conducting condition of installed connectors in storage, shipment or during transportation.

Materials

●SMT unit

Parts		Material	Finish	Remarks
Insulator		PPS	Color : Black	UL94V-0
Terminal	Card connected section	Brass	Contact area: Gold plated Termination area: Tin-lead plated	—
	Ground plate	Phosphor bronze	Contact area: Gold plated Termination area: Tin-lead plated	—
Eject metal fittings		Stainless steel	—	—

●Guide unit

Description		Material	Finish	Remarks	
Guide plate		Stainless steel	—	—	
Pushrod		Stainless steel	—	—	
Eject button	Rigid button	Body	PBT	Color : Black UL94V-0	
		Body	PBT	Color: Black UL94V-0	
	Foldering button	Spring	Stainless steel	—	—
		Spring pin	Stainless steel	—	—
		Body	PBT	Color: Black UL94V-0	
	Pop-up Version 1	Frame metal	Stainless steel	—	—
		Spring	Steel	—	—
Pin		Brass	Nickel plated	—	
Nut (Note)		Steel	—	M2x0.4	
Eject button	Pop-up Version 2	Body	PBT	Color: Black UL94V-0	
		Spring	Steel	—	
		Cam	Zinc alloy	—	

Note: Nut is integrated in guide plated of pop-up version 2 connectors.

■ Ordering Information

● SMT Unit

IC11S A - 68 PLR - 1.27SF - EJ R (71)

①
②
③
④
⑤
⑥
⑦
⑧

① Series name : IC11S	⑤ 1.27SF : 1.27mm pitch SMT connector (Note)
② Standoff type Blank : none A : 2.2mm	⑥ With ejector
③ Number of contacts : 68 (Note)	⑦ Eject button positions R : right L : left
④ Board Mounting Method: PL : standard type PLR : reverse type	⑧ Lead free spec (71) specification

Note: 68 and 1.27 are omitted from part number

● Guide Unit

IC11S A - BUR - PNEJ R

⑨
⑩
⑪
⑫
⑬

⑨ Series name : IC11S	⑫ Eject button type EJ : rigid button FEJ : Foldering button PEJ : Pop-up version 1 button PNEJ : Pop-up version 2 button
⑩ Standoff type Blank: none A : 2.2mm	⑬ Eject button positions R : right L : left
⑪ Board Mounting Method BD : standard type BUR : reverse type	

(Note.) IC11S Series will be used in combination of SMT unit with guide unit. When using, please select the same type for the following items. Note that other combinations cannot be used.

- Series name (① ⇔ ⑨)
- Standoff type (② ⇔ ⑩)
- Board Mounting Method (④ ⇔ ⑪)
- Eject button positions (⑦ ⇔ ⑬)

Standard
Right rigid button type

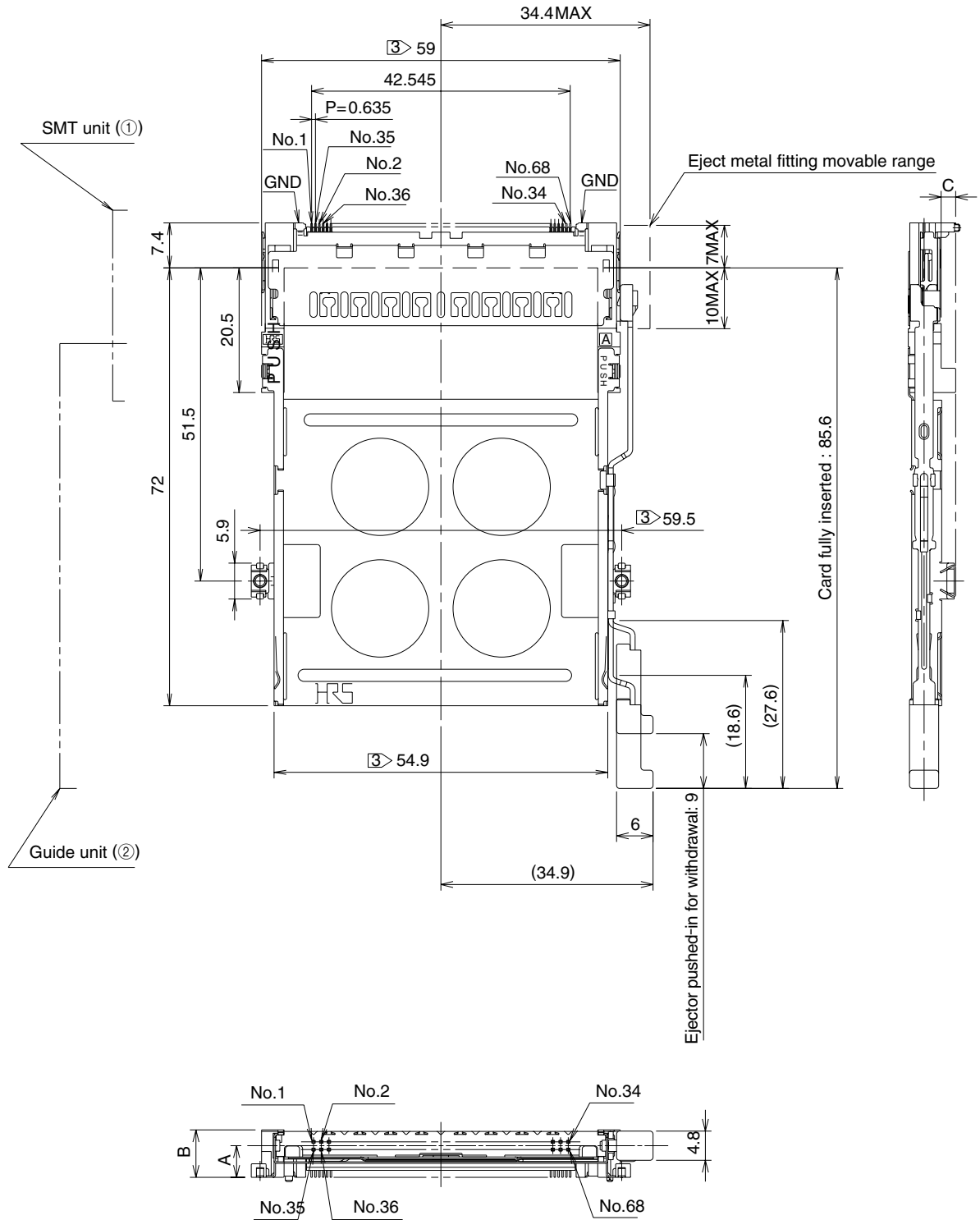

Standoff type	SMT unit ①		Guide unit ②		A (mm)	B (mm)	C (mm)	Weight (g)
	Part Number	CL No.	Part Number	CL No.				
0mm	IC11S-68PL-1.27SF-EJR	640-1007-3	IC11S-BD-EJR	640-1071-2	3	5.6	0.1	12.7
2.2mm	IC11SA-68PL-1.27SF-EJR	640-1009-9	IC11SA-BD-EJR	640-1073-8	5.2	7.8	2.3	13.1

Note 1: This figure illustrates grouping of SMT unit (①) and guide unit (②) together.

Note 2: Dimensions for card fitting are in accordance with "PC card standard".

Note 3: Indicated dimensions are symmetrical to the center of the card insertion slot.

Right folding button type

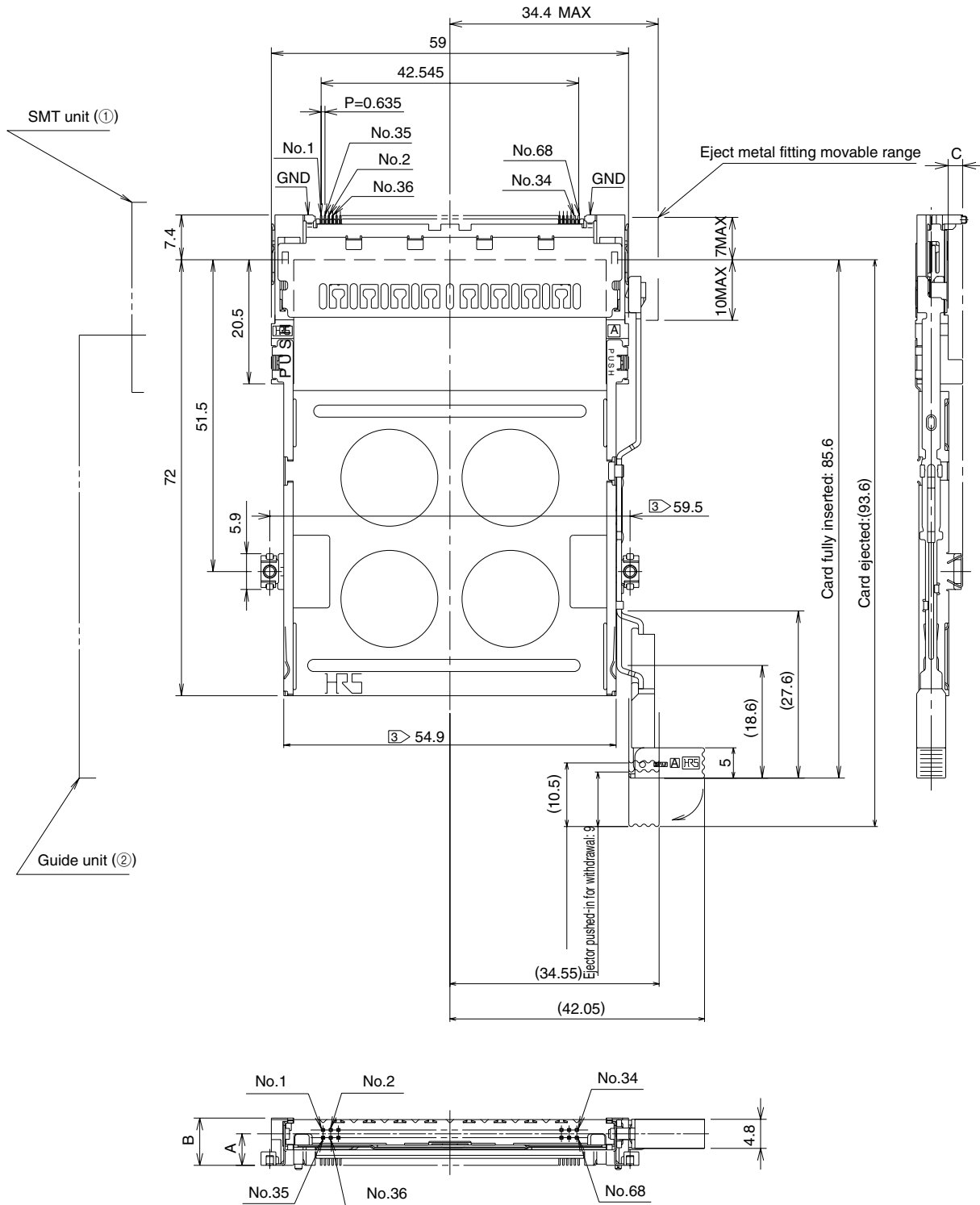

Standoff type	SMT unit ①		Guide unit ②		A (mm)	B (mm)	C (mm)	Weight (g)
	Part Number	CL No.	Part Number	CL No.				
0mm	IC11S-68PL-1.27SF-EJR	640-1007-3	IC11S-BD-FEJR	640-1075-3	3	5.6	0.1	13.1
2.2mm	IC11SA-68PL-1.27SF-EJRa	640-1009-9	IC11SA-BD-FEJR	640-1077-9	5.2	7.8	2.3	13.5

Note 1: This figure illustrates grouping of SMT unit (①) and guide unit (②) together.

Note 2: Dimensions for card fitting are in accordance with "PC card standard".

Note 3: Indicated dimensions are symmetrical to the center of the card insertion slot.

Right Pop-up (Version 1) button type

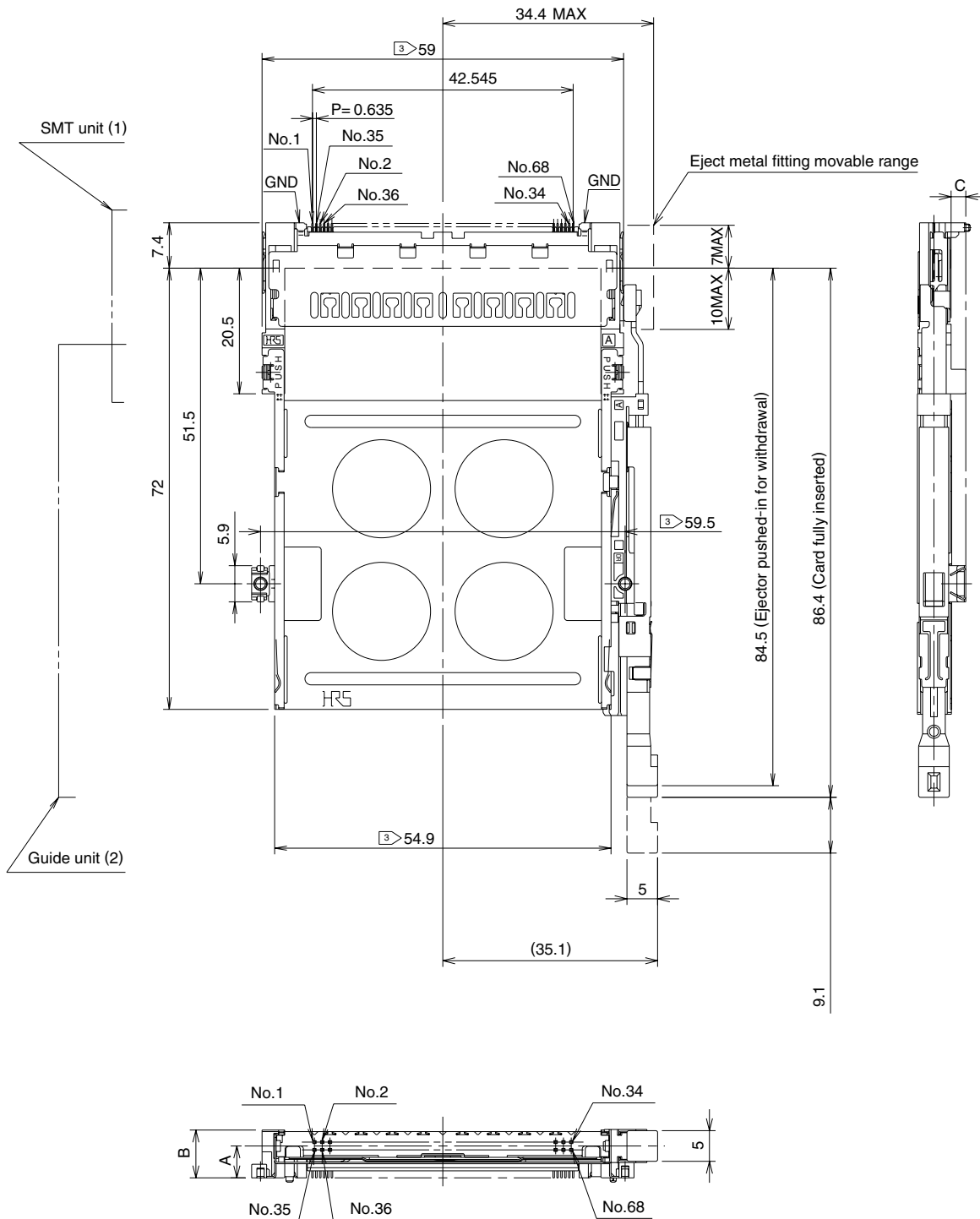

Standoff type	SMT unit ①		Guide unit ②		A (mm)	B (mm)	C (mm)	Weight (g)
	Part Number	CL No.	Part Number	CL No.				
0mm	IC11S-68PL-1.27SF-EJR	640-1007-3	IC11S-BD-PEJR	640-1081-6	3	5.7	0.1	14.7
2.2mm	IC11SA-68PL-1.27SF-EJR	640-1009-9	IC11SA-BD-PEJR	640-1083-1	5.2	7.9	2.3	15.1

Note 1: This figure illustrates grouping of SMT unit (①) and guide unit (②) together.

Note 2: Dimensions for card fitting are in accordance with "PC card standard".

Note 3: Indicated dimensions are symmetrical to the center of the card insertion slot.

Standard

Left Pop-up (Version 1) button type

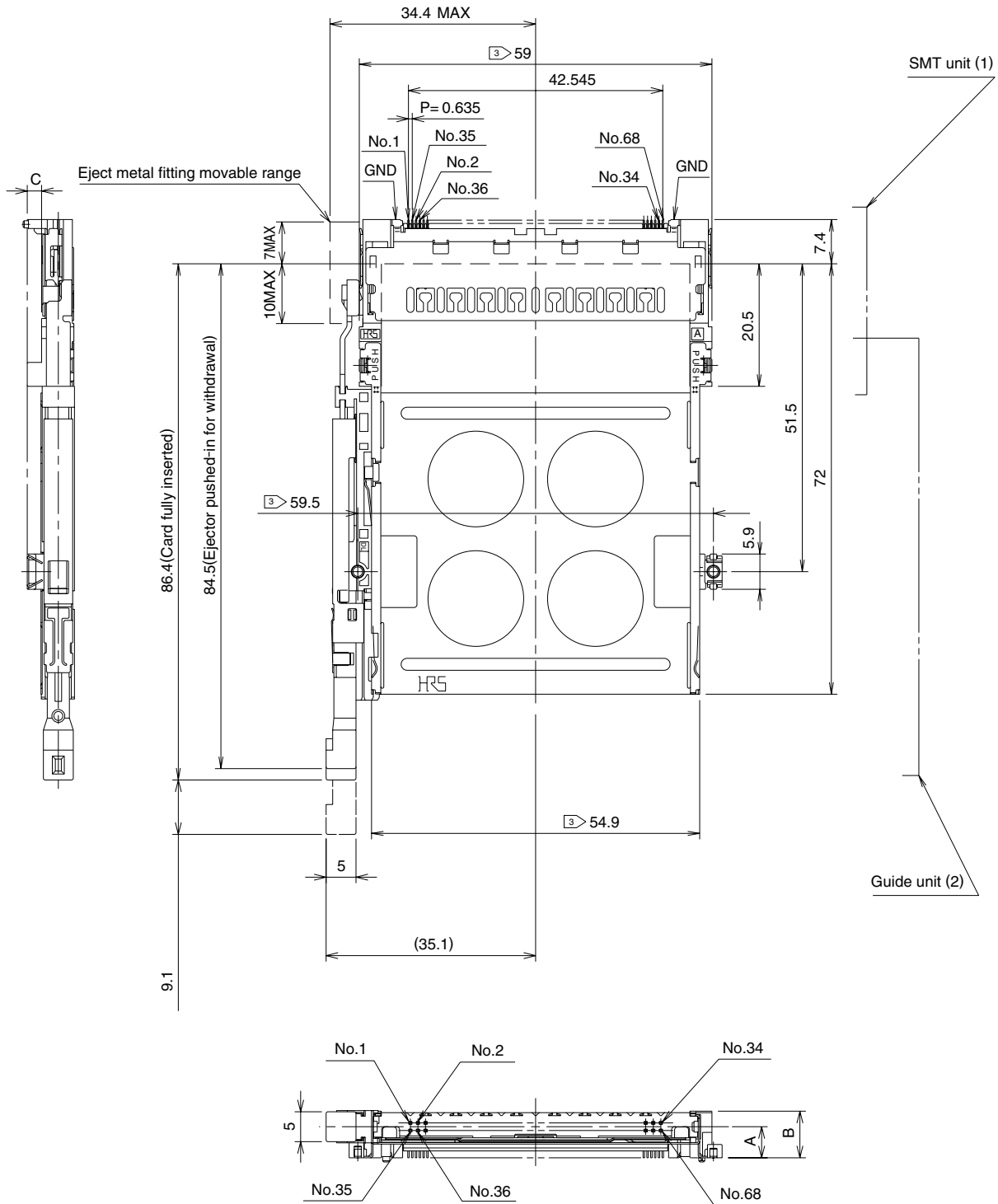

Standoff type	SMT unit ①		Guide unit ②		A (mm)	B (mm)	C (mm)	Weight (g)
	Part Number	CL No.	Part Number	CL No.				
0mm	IC11S-68PL-1.27SF-EJL	640-1008-6	IC11S-BD-PEJL	640-1082-9	3	5.7	0.1	14.7
2.2mm	IC11SA-68PL-1.27SF-EJL	640-1010-8	IC11SA-BD-PEJL	640-1084-4	5.2	7.9	2.3	15.1

Note 1: This figure illustrates grouping of SMT unit (①) and guide unit (②) together.

Note 2: Dimensions for card fitting are in accordance with "PC card standard".

Note 3: Indicated dimensions are symmetrical to the center of the card insertion slot.

Right Pop-up (Version 2) button type

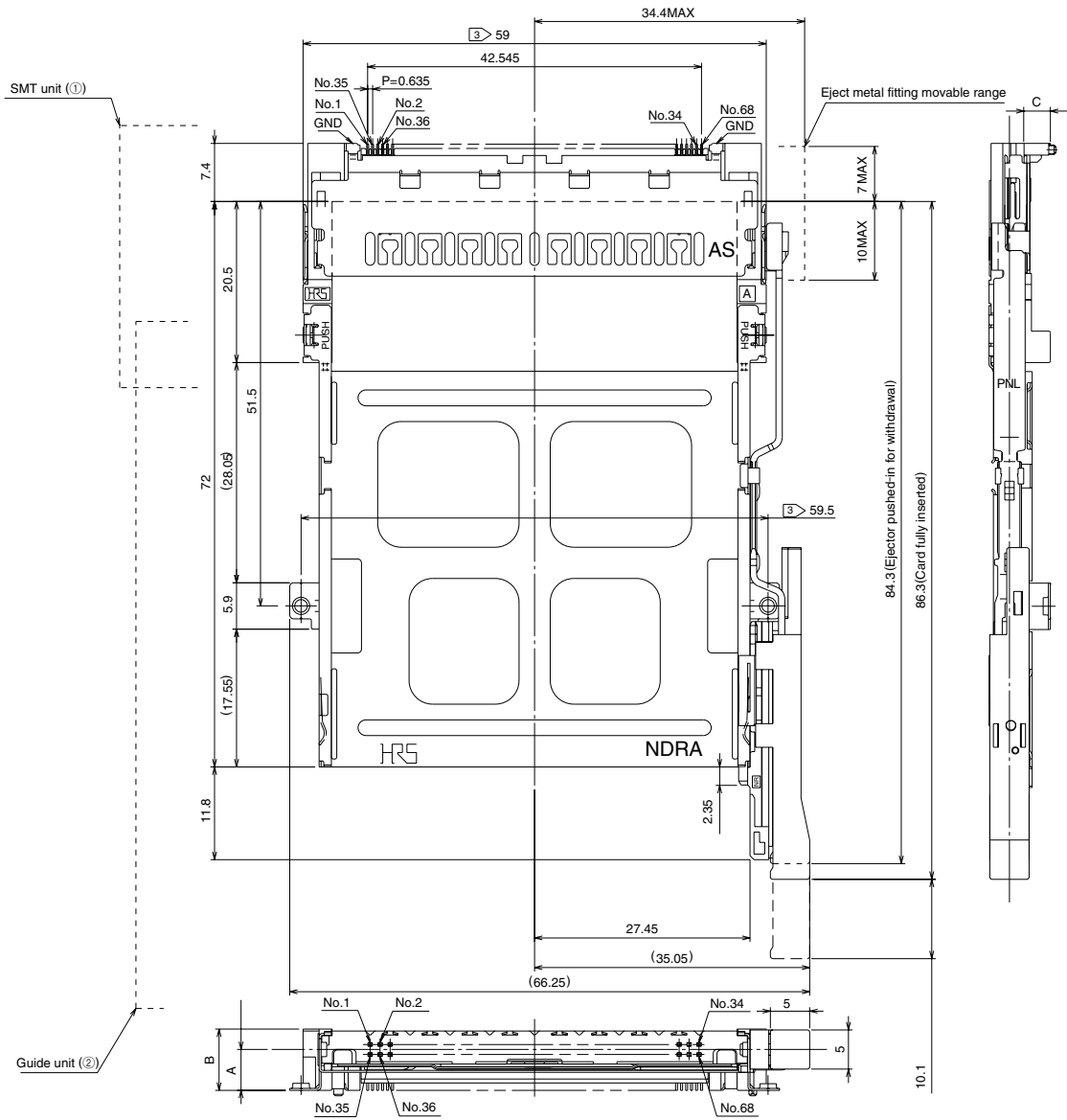

Standoff type	SMT unit ①		Guide unit ②		A (mm)	B (mm)	C (mm)	Weight (g)
	Part Number	CL No.	Part Number	CL No.				
0mm	IC11S-68PL-1.27SF-EJR	640-1007-3	IC11S-BD-PNEJR	640-1251-4	3	5.6	0.1	13.1
2.2mm	IC11SA-68PL-1.27SF-EJR	640-1009-9	IC11SA-BD-PNEJR	640-1253-0	5.2	7.8	2.3	13.6

Note 1: This figure illustrates grouping of SMT unit (①) and guide unit (②) together.

Note 2: Dimensions for card fitting are in accordance with "PC card standard".

Note 3: Indicated dimensions are symmetrical to the center of the card insertion slot.

Standard

Left Pop-up (Version 2) button type

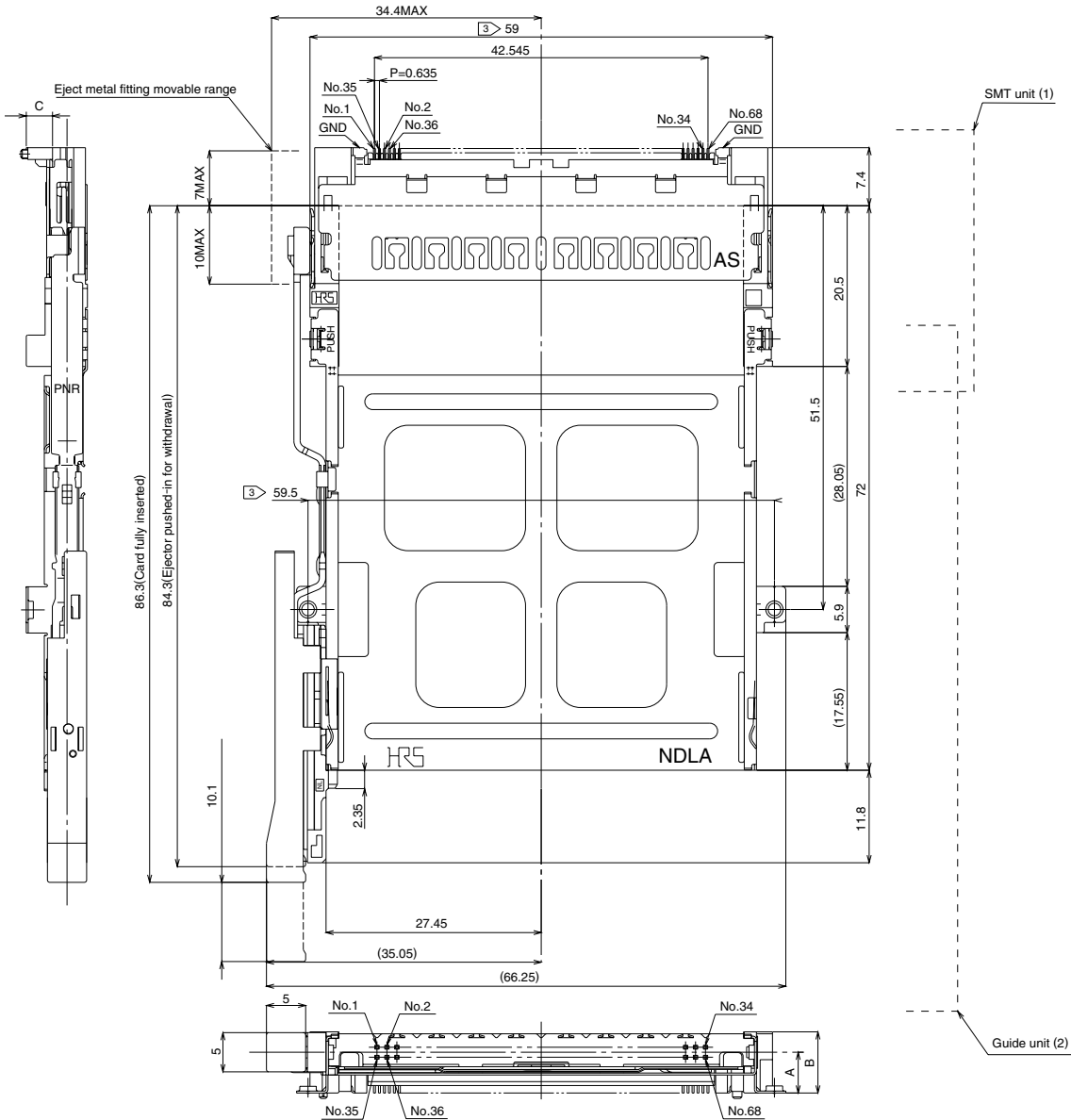

Standoff type	SMT unit ①		Guide unit ②		A (mm)	B (mm)	C (mm)	Weight (g)
	Part Number	CL No.	Part Number	CL No.				
0mm	IC11S-68PL-1.27SF-EJL	640-1008-6	IC11S-BD-PNEJL	640-1252-7	3	5.6	0.1	13.1
2.2mm	IC11SA-68PL-1.27SF-EJL	640-1010-8	IC11SA-BD-PNEJL	640-1254-2	5.2	7.8	2.3	13.6

Note 1: This figure illustrates grouping of SMT unit (①) and guide unit (②) together.

Note 2: Dimensions for card fitting are in accordance with "PC card standard".

Note 3: Indicated dimensions are symmetrical to the center of the card insertion slot.

Reverse

Right rigid button type

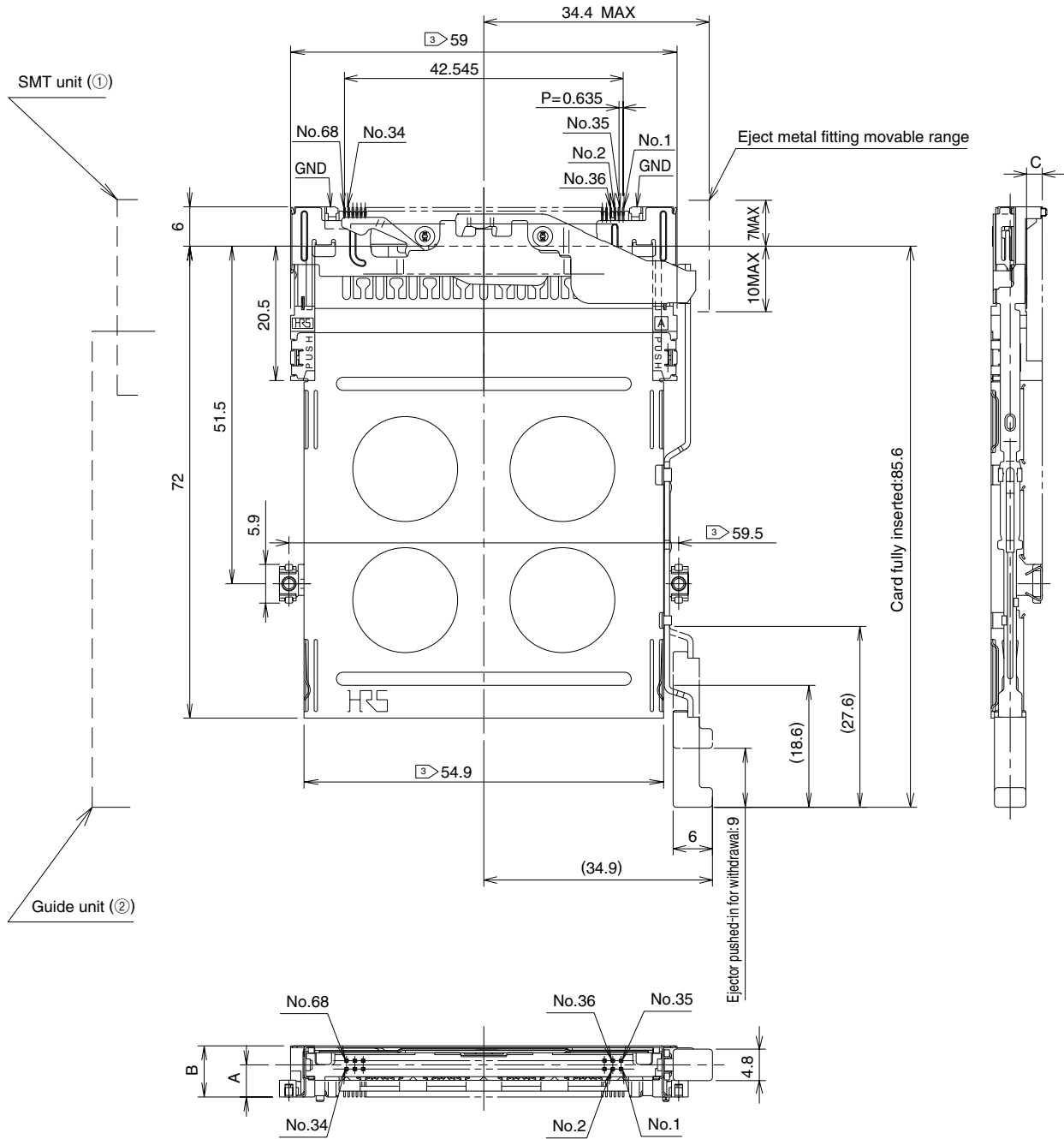

Standoff type	SMT unit ①		Guide unit ②		A (mm)	B (mm)	C (mm)	Weight (g)
	Part Number	CL No.	Part Number	CL No.				
0mm	IC11S-68PLR-1.27SF-EJR	640-1003-2	IC11S-BUR-EJR	640-1055-6	2.7	5.6	0.1	13.1
2.2mm	IC11SA-68PLR-1.27SF-EJR	640-1005-8	IC11SA-BUR-EJR	640-1057-1	4.9	7.8	2.3	13.6

Note 1: This figure illustrates grouping of SMT unit (①) and guide unit (②) together.

Note 2: Dimensions for card fitting are in accordance with "PC card standard".

Note 3: Indicated dimensions are symmetrical to the center of the card insertion slot.

Reverse
Left rigid button type

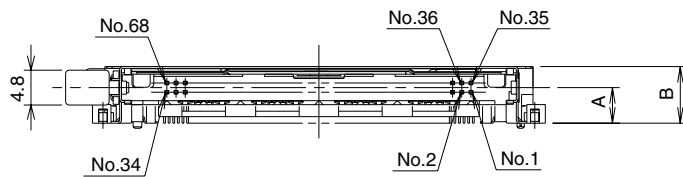
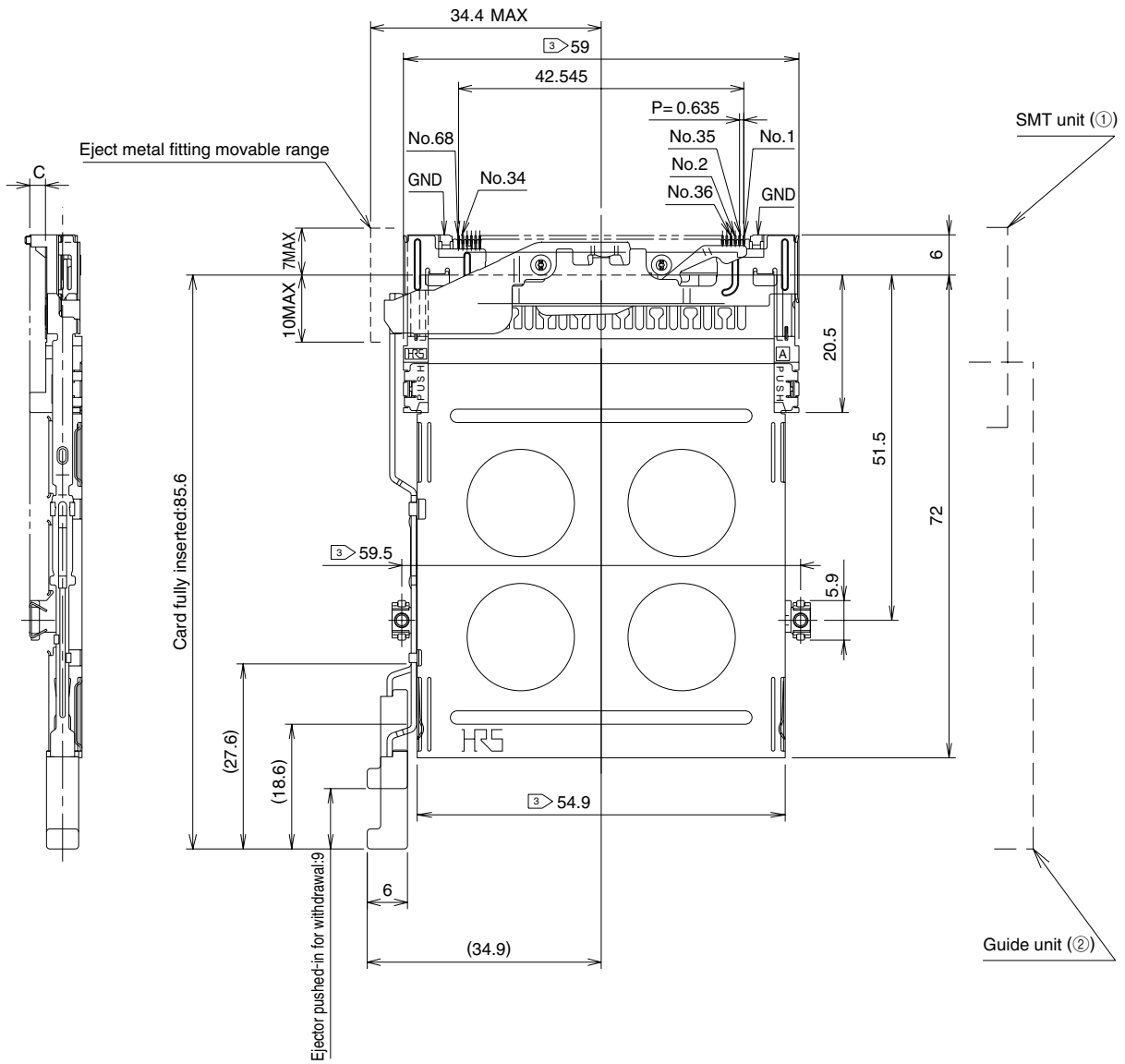

Standoff type	SMT unit ①		Guide unit ②		A (mm)	B (mm)	C (mm)	Weight (g)
	Part Number	CL No.	Part Number	CL No.				
0mm	IC11S-68PLR-1.27SF-EJL	640-1004-5	IC11S-BUR-EJL	640-1056-9	2.7	5.6	0.1	13.1
2.2mm	IC11SA-68PLR-1.27SF-EJL	640-1006-0	IC11SA-BUR-EJL	640-1058-4	4.9	7.8	2.3	13.6

Note 1: This figure illustrates grouping of SMT unit ① and guide unit ② together.

Note 2: Dimensions for card fitting are in accordance with "PC card standard".

Note 3: Indicated dimensions are symmetrical to the center of the card insertion slot.

Reverse

Right folding button type

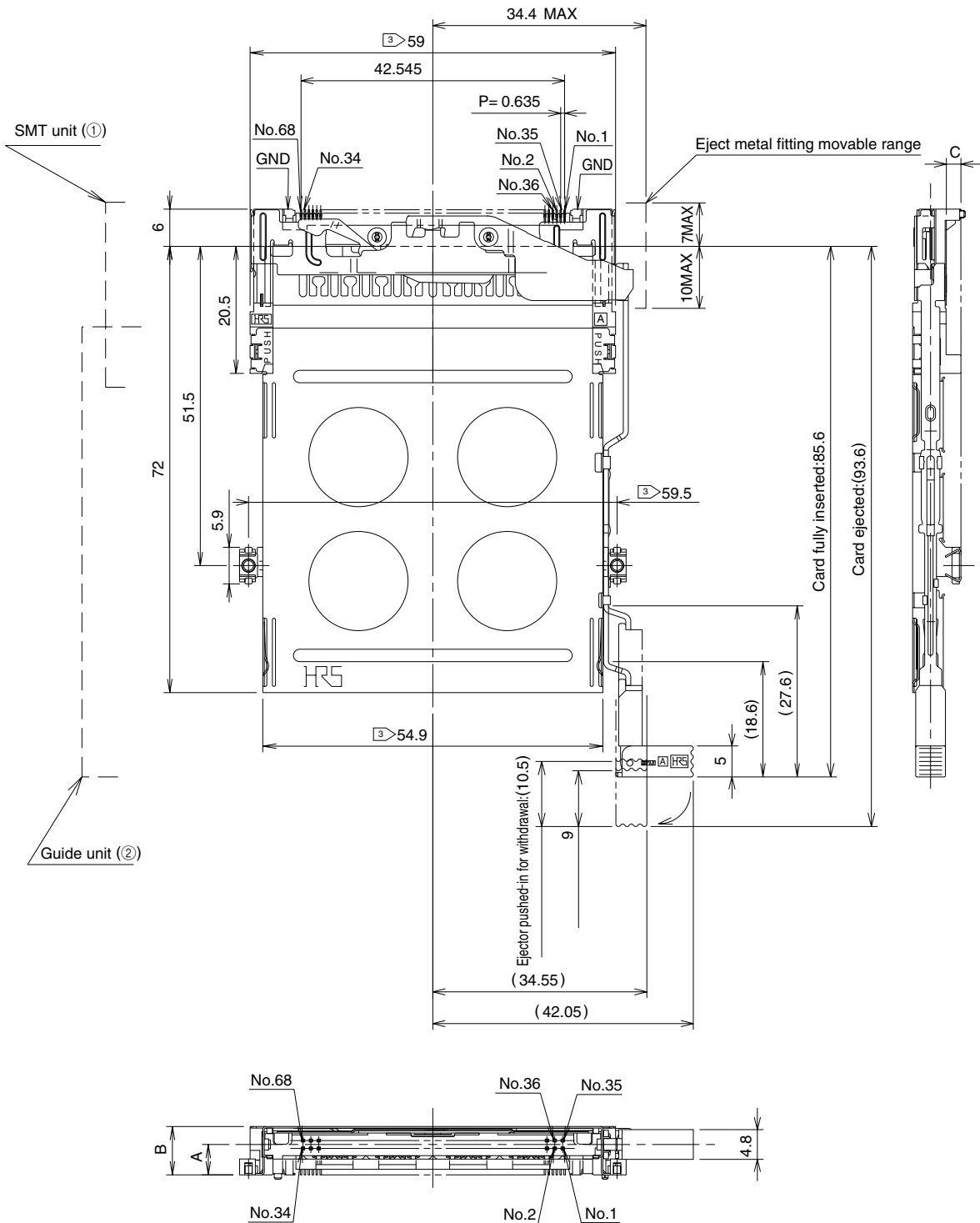

Standoff type	SMT unit ①		Guide unit ②		A (mm)	B (mm)	C (mm)	Weight (g)
	Part Number	CL No.	Part Number	CL No.				
0mm	IC11S-68PLR-1.27SF-EJR	640-1003-2	IC11S-BUR-FEJR	640-1059-7	2.7	5.6	0.1	13.5
2.2mm	IC11SA-68PLR-1.27SF-EJR	640-1005-8	IC11SA-BUR-FEJR	640-1061-9	4.9	7.8	2.3	14

Note 1: This figure illustrates grouping of SMT unit (①) and guide unit (②) together.

Note 2: Dimensions for card fitting are in accordance with "PC card standard".

Note 3: Indicated dimensions are symmetrical to the center of the card insertion slot.

Reverse

Left Pop-up (Version 1) button type

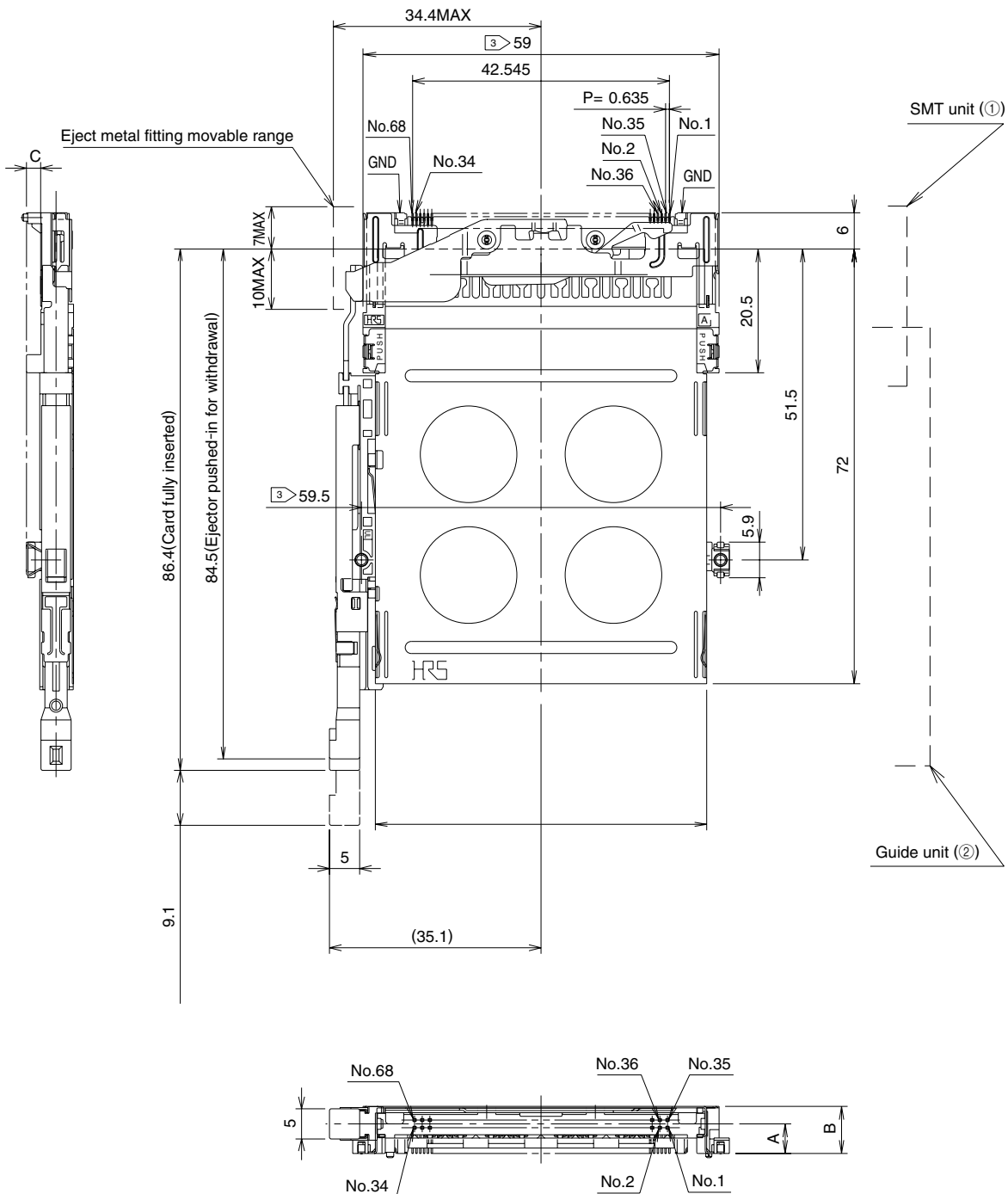

Standoff type	SMT unit ①		Guide unit ②		A (mm)	B (mm)	C (mm)	Weight (g)
	Part Number	CL No.	Part Number	CL No.				
0mm	IC11S-68PLR-1.27SF-EJR	640-1003-2	IC11S-BUR-PEJR	640-1065-0	2.7	5.6	0.1	15.1
2.2mm	IC11SA-68PLR-1.27SF-EJR	640-1005-8	IC11SA-BUR-PEJR	640-1067-5	4.9	7.8	2.3	15.6

Note 1: This figure illustrates grouping of SMT unit ① and guide unit ② together.

Note 2: Dimensions for card fitting are in accordance with "PC card standard".

Note 3: Indicated dimensions are symmetrical to the center of the card insertion slot.

Right Pop-up (Version 2) button type

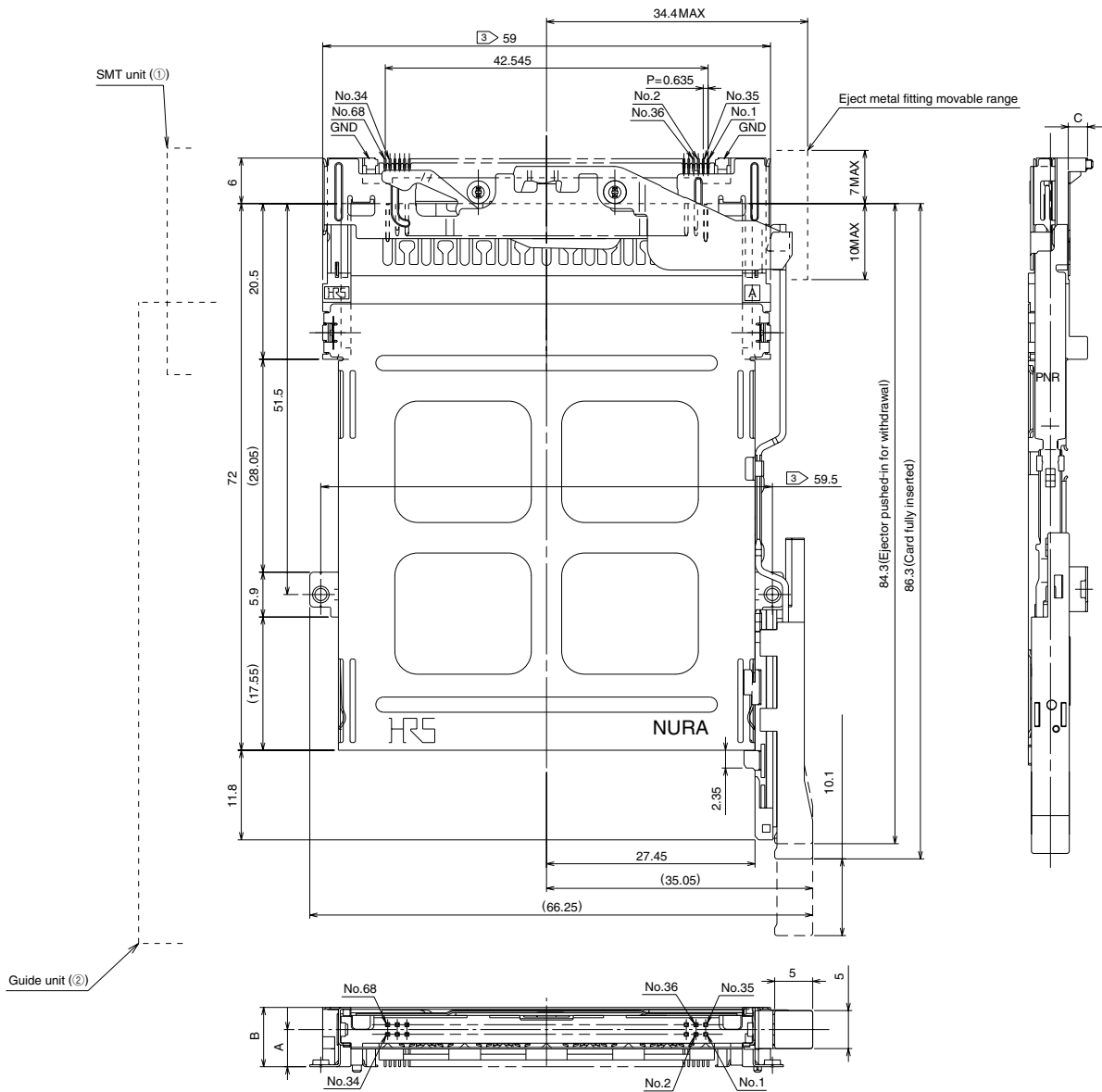

Standoff type	SMT unit ①		Guide unit ②		A (mm)	B (mm)	C (mm)	Weight (g)
	Part Number	CL No.	Part Number	CL No.				
0mm	IC11S-68PLR-1.27SF-EJR	640-1003-2	IC11S-BUR-PNEJR	640-1065-0	2.7	5.6	0.1	13.3
2.2mm	IC11SA-68PLR-1.27SF-EJR	640-1005-8	IC11SA-BUR-PNEJR	640-1067-5	4.9	7.8	2.3	13.7

Note 1: This figure illustrates grouping of SMT unit (①) and guide unit (②) together.

Note 2: Dimensions for card fitting are in accordance with "PC card standard".

Note 3: Indicated dimensions are symmetrical to the center of the card insertion slot.

◆PCB mounting pattern

●Standard

●Without Standoff

(Right button)

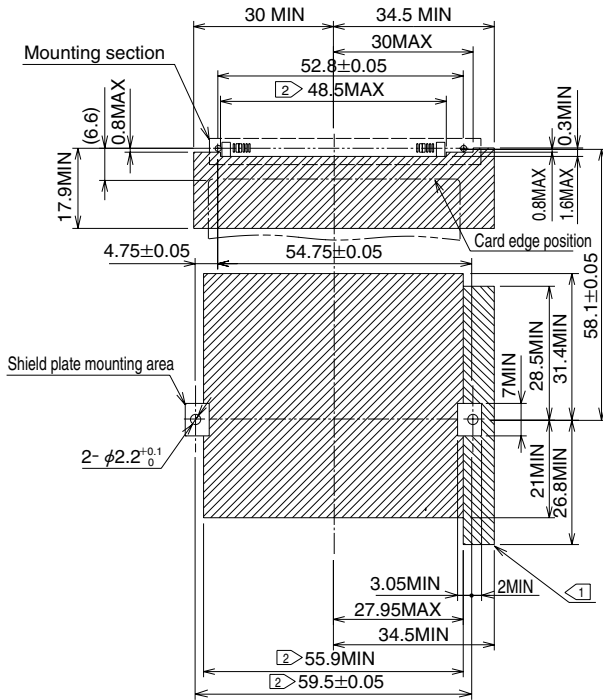

●Without standoff

(left button)

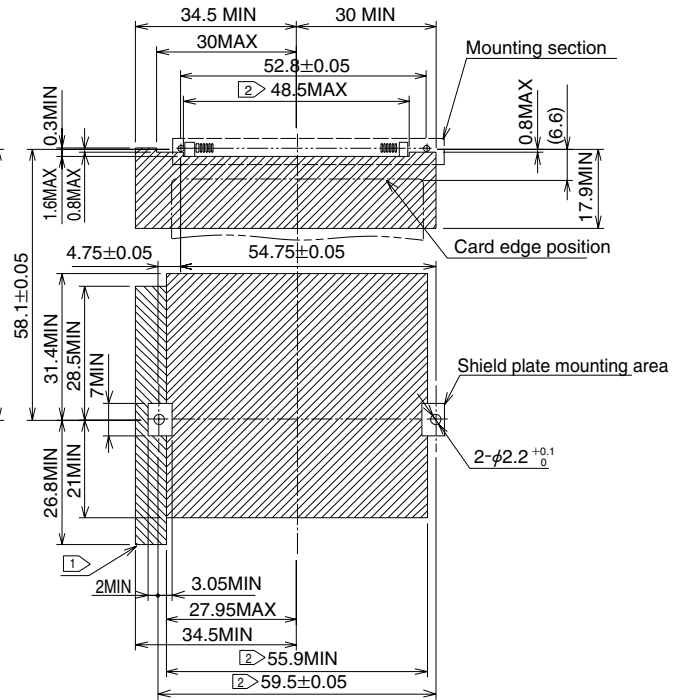

●Standoff 2.2mm

(Common to both Right & left buttons)

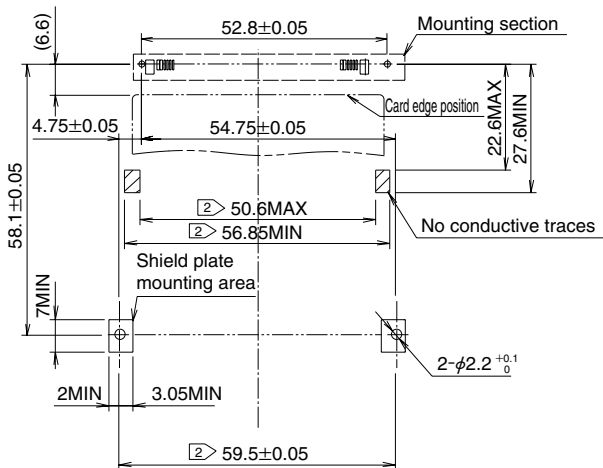

Note1) area and area show the pattern-inhibited area.

However area will be the pattern-inhibited area only when guide unit is "IC11S-BD-PEJ**".

Note2) Indicated dimensions are symmetrical to the center of the card insertion slot.

◆PCB mounting pattern Pop-up (Version 2) button type

●Standard

●Without Standoff (Right button)

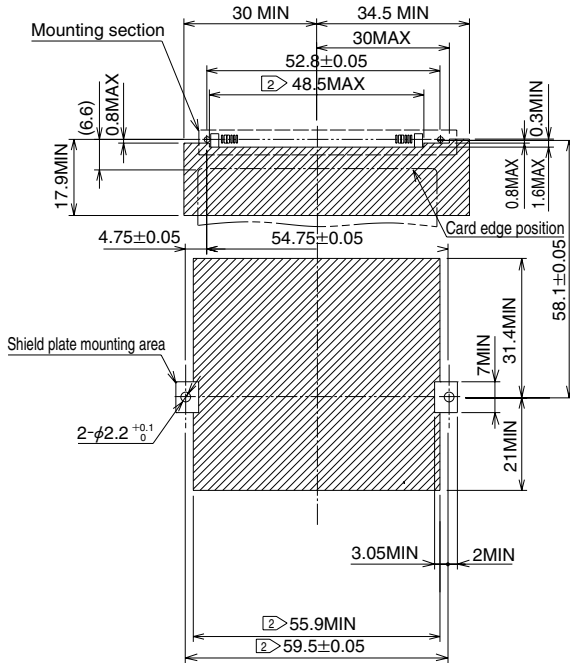

●Without Standoff (left button)

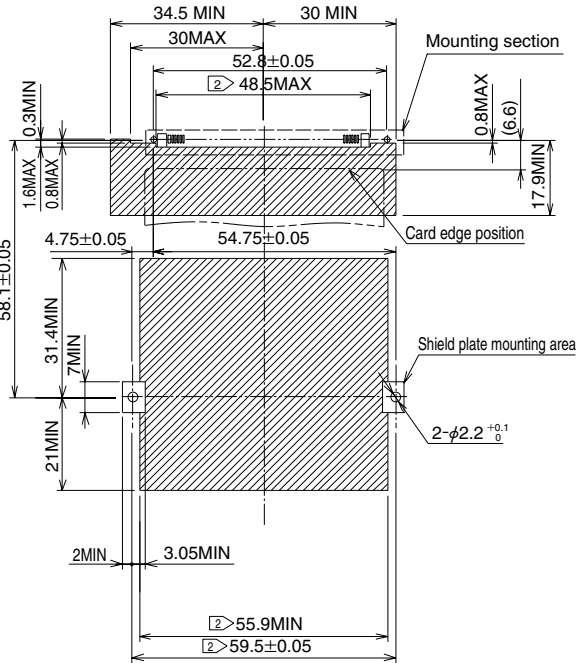

●Standoff 2.2mm

(common to both Right and left buttons)

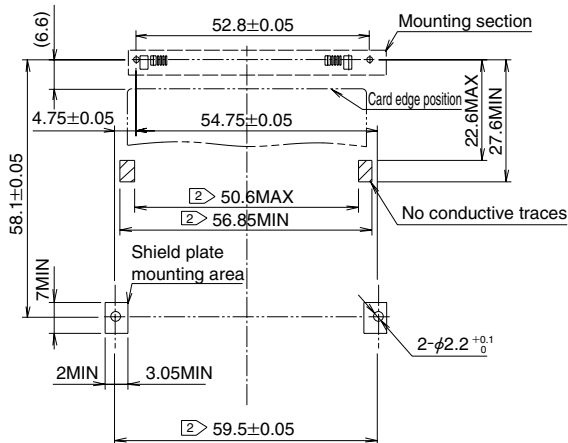

Note1) area show the pattern-inhibited area.

Note2) Indicated dimensions are symmetrical to the center of the card insertion slot.

◆PCB mounting pattern (Enlarged)

●Standard

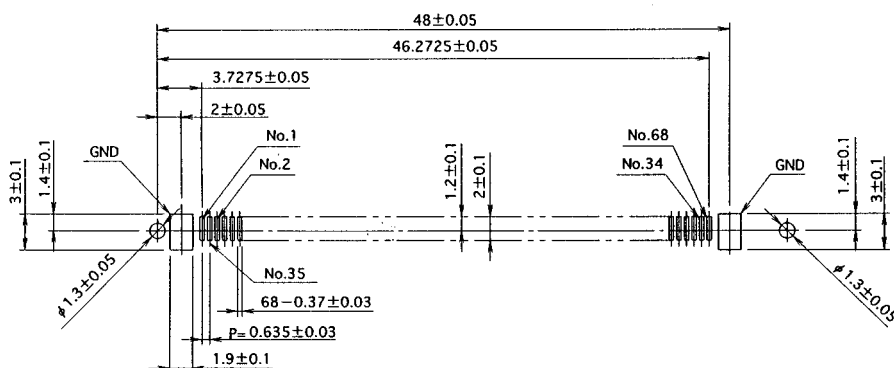

●Without Standoff

(Right button)

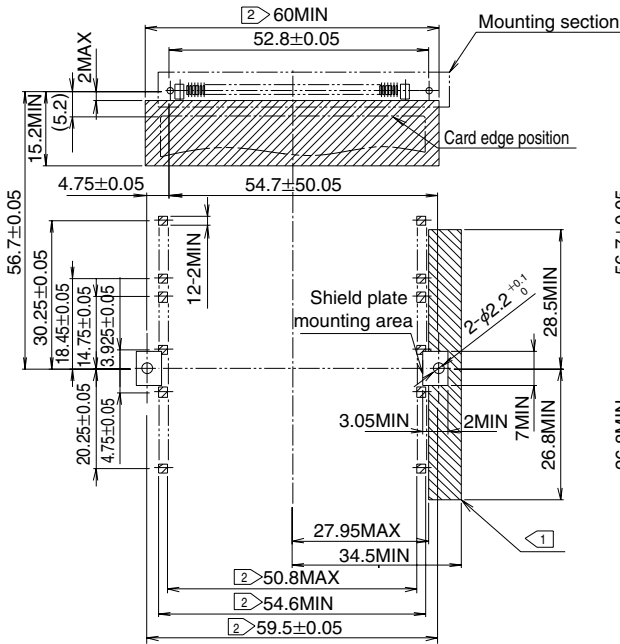

●Without standoff

(left button)

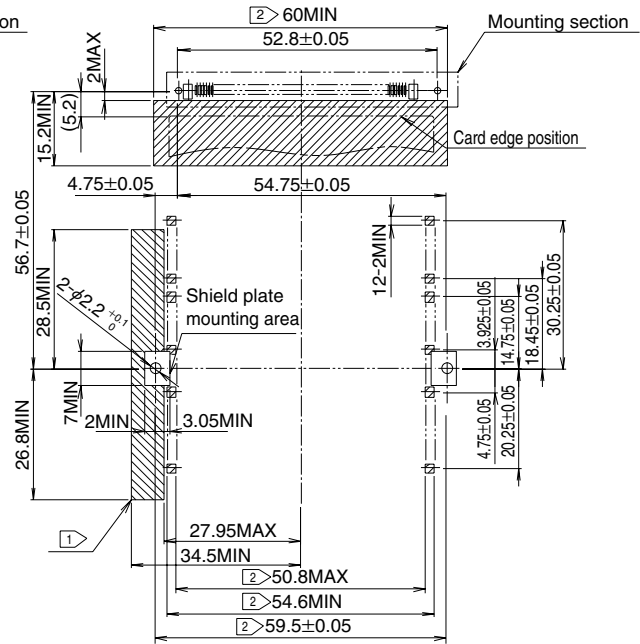

●Standoff 2.2mm

(common to both right and left buttons)

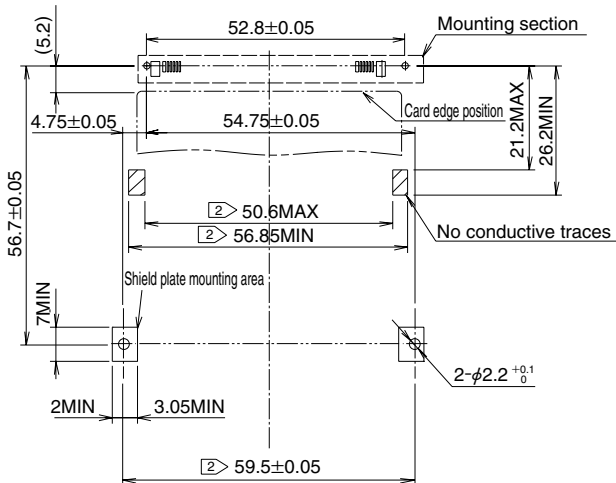

Note1) area and area show the pattern-inhibited area.

However area will be the pattern-inhibited area only when guide unit is "IC11S-BD-PEJ**".

Note2) Indicated dimensions are symmetrical to the center of the card insertion slot.

Pop-up (Version 2) button type

●Reverse

●Without Standoff

(Common to both Right & left buttons)

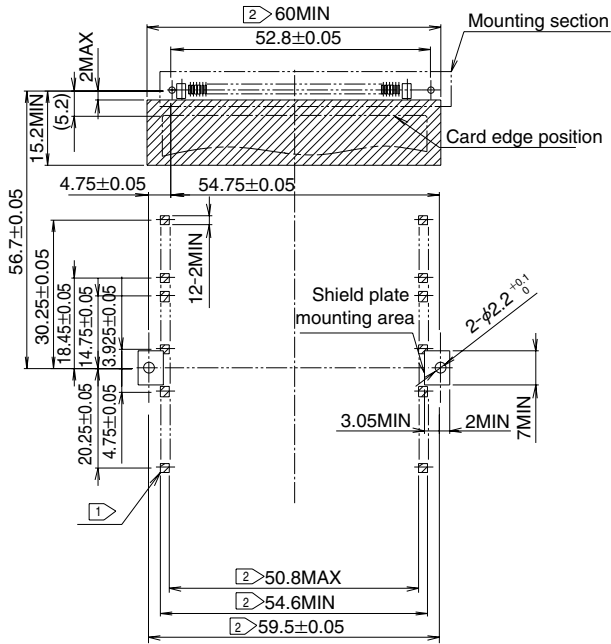

●Standoff 2.2mm

(common to both right and left buttons)

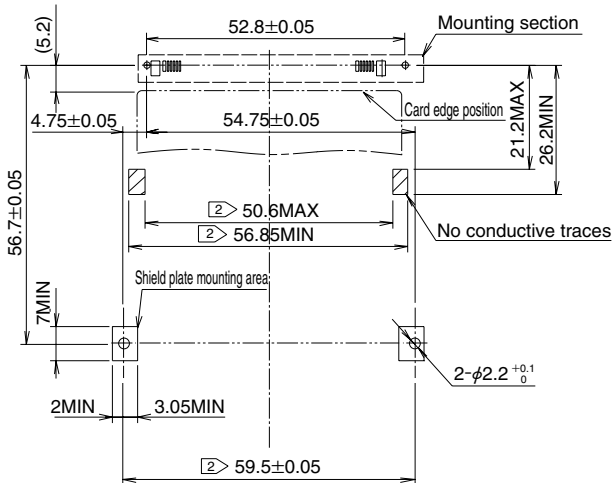

Note1) area show the pattern-inhibited area.

Note2) Indicated dimensions are symmetrical to the center of the card insertion slot.

◆PCB mounting pattern (Enlarged)

●Reverse

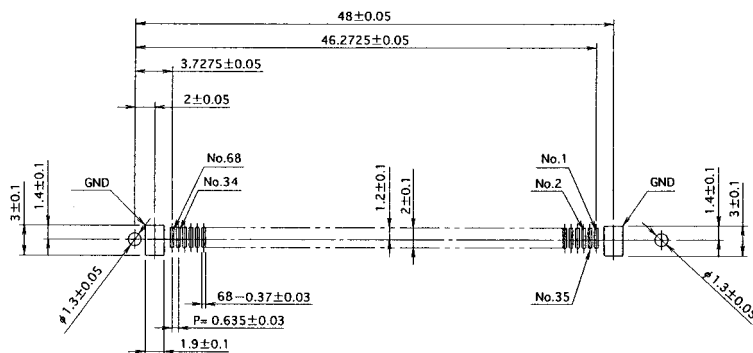

◆ Installation to the Board (Standard Type)

(1) Mount the SMT unit.

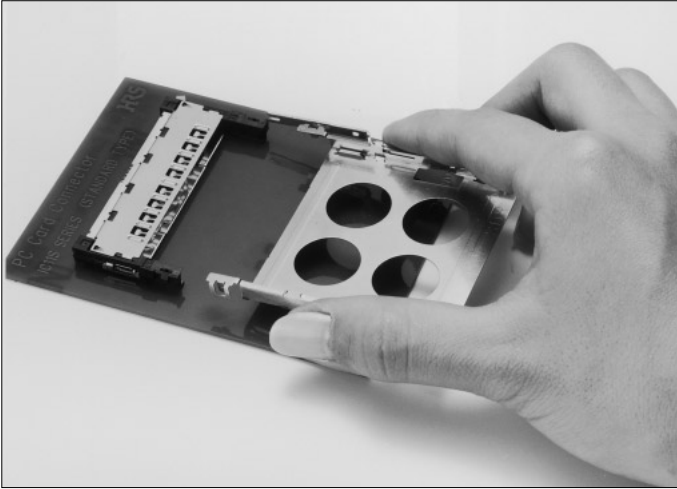

(2) Position the locking portion of the guide unit over the hole of the SMT unit.

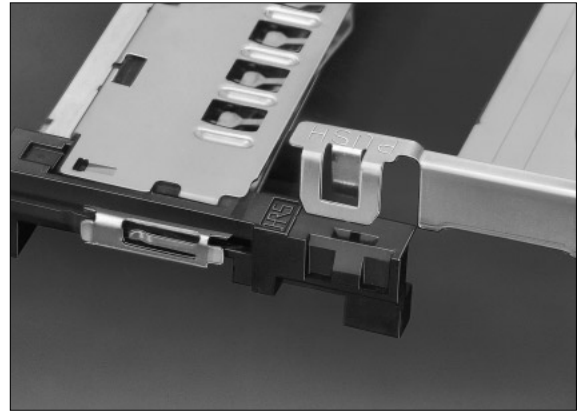
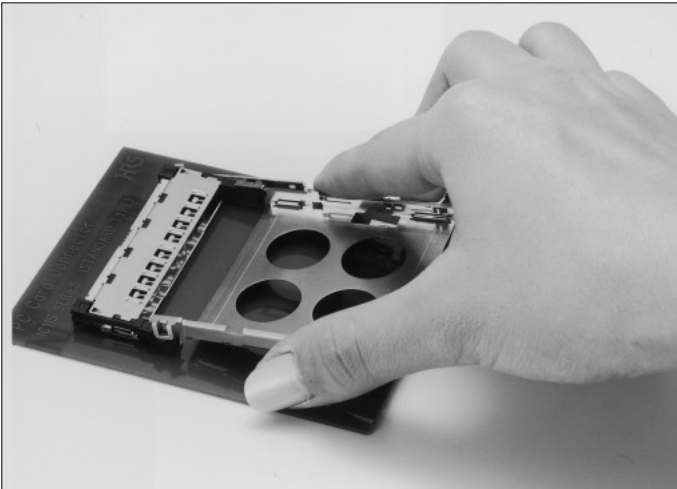

(3) Press the top portion of the lock of the guide unit (until a click sound is heard) to securely engage it with the SMT unit.

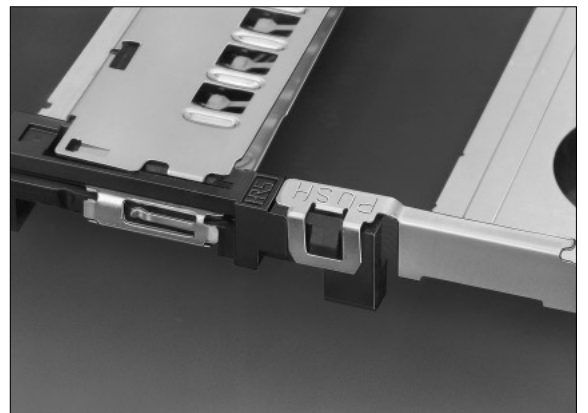
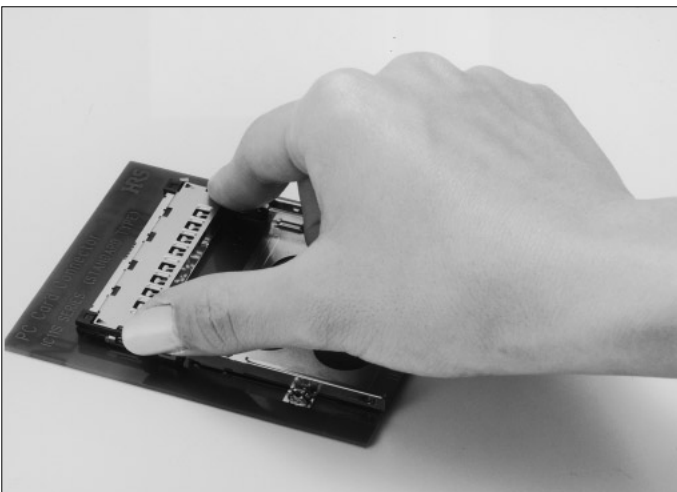

Note: Avoid pressing locations other than the top portion of the lock. Failing to do so will result in deformation of the guide plate.

(4) Use screws to fasten the guide unit at two places from the rear of the board.

Screw Name	Pitch	Recommended Torque
M2	0.4	1.5 to 2.0(kgf · cm)

◆ Installation to the Board (Reverse Type)

(1) Mount the SMT unit.

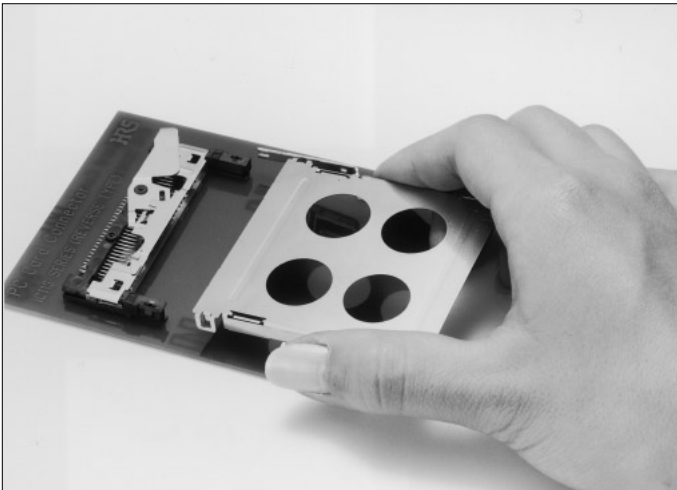

(2) Position the locking portion of the guide unit over the hole of the SMT unit. Position the lock section of guide unit into the hole of SMT unit.

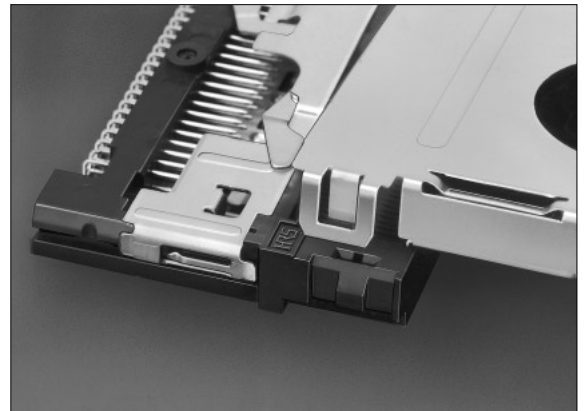
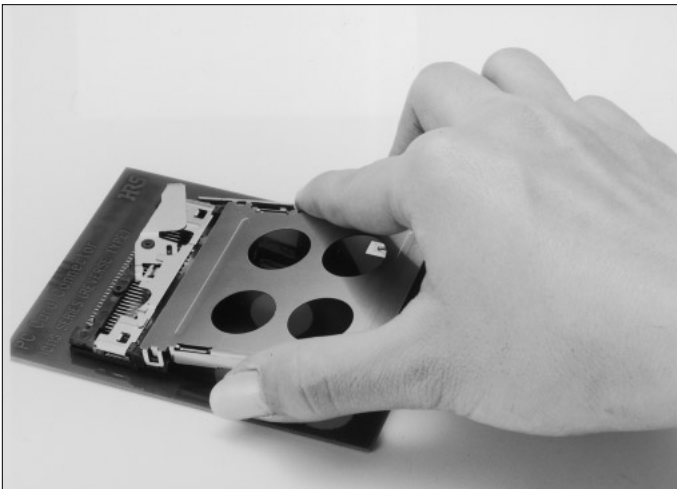

(3) Press the top portion of the lock of the guide unit (until a click sound is heard) to securely engage it with the SMT unit.

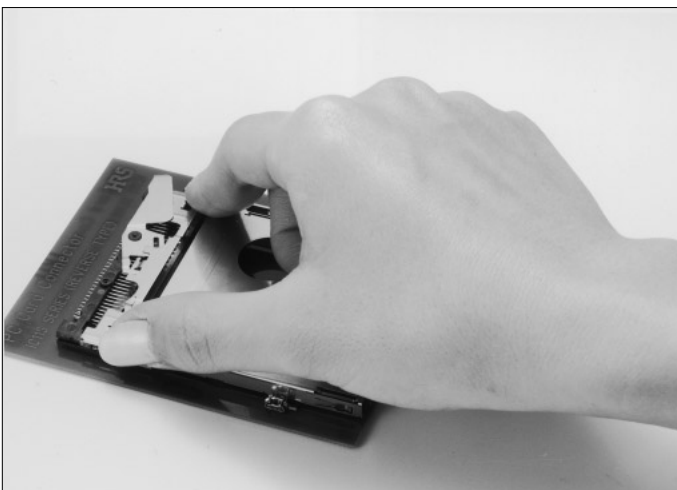

Note: Avoid pressing locations other than the top portion of the lock. Failing to do so will result in deformation of the guide plate.

(4) Use screws to fasten the guide unit at two places from the rear of the board.

Screw Name	Pitch	Recommended Torque
M2	0.4	1.5~2.0(kgf · cm)

◆ Cautions In Installation To Boards

1. After mounting the SMT unit to the board, check that the stroke arm of the SMT unit and the push rod of the guide unit are located in the position of Photograph 1. (At the time of delivery, these parts are positioned as indicated in the photographs.) Please note that reflow cannot be used with the guide unit.

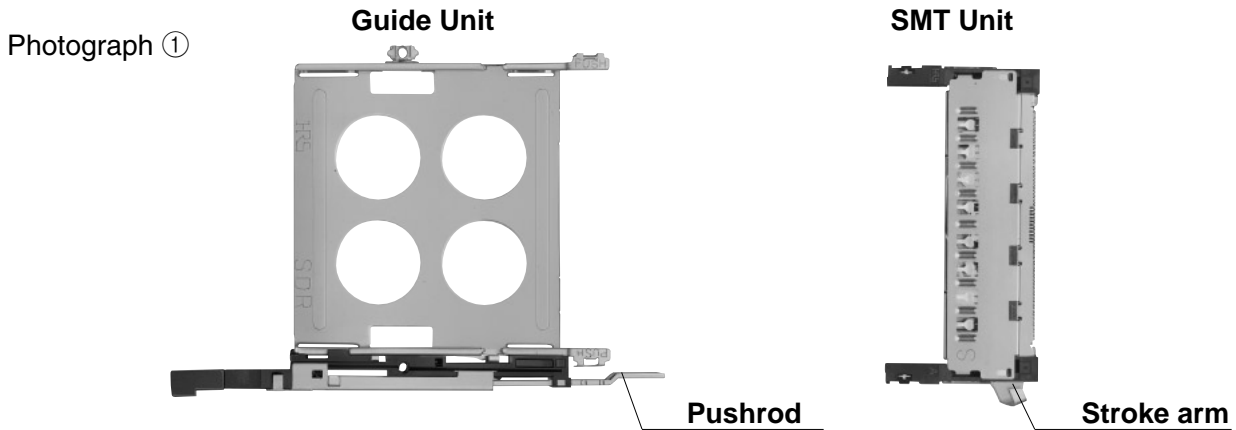

2. Note that the units cannot be combined when the stroke arm of the SMT unit and the push rod of the guide unit are in the positions indicated in Photograph 2.

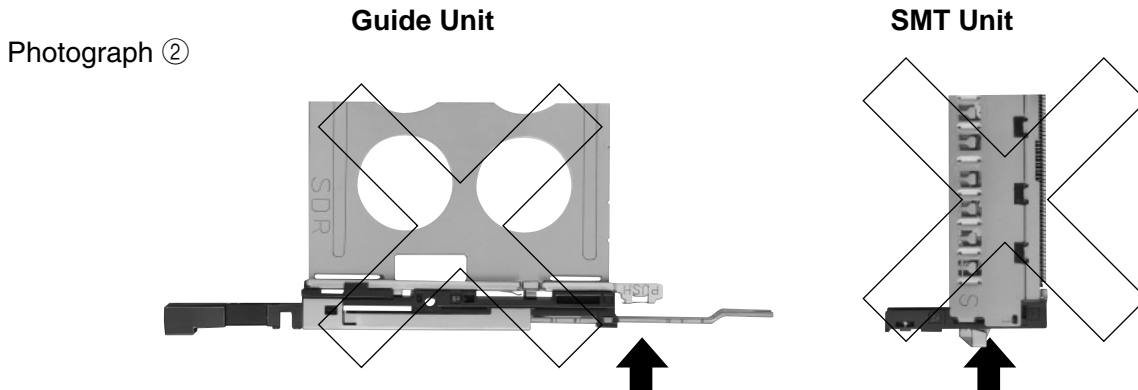

When the aforementioned parts are positioned as indicated in Photograph 2, use your finger to move them to the positions indicated in Photograph 1.

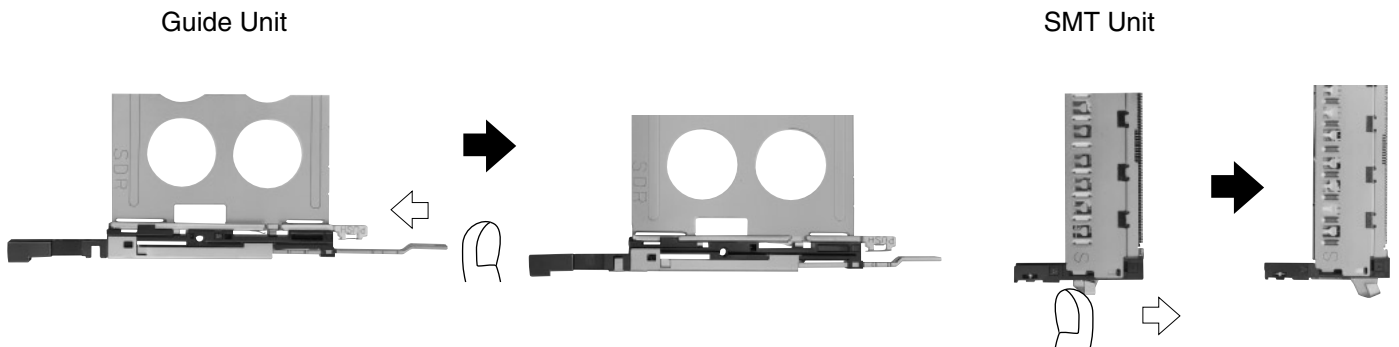

3. After combining the SMT unit and the guide unit, they will appear as shown below.

● Push rod has been pushed in

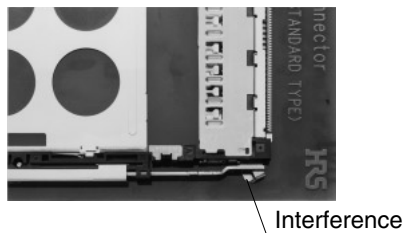

● Push rod has been pulled out

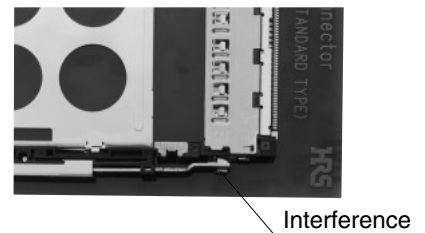

◆Precautions

The guide plate has sharp portions because it is made of metal. Use due caution when handling because there is the danger of cutting a finger. Guide plate is metallic, having some sharp-edged portions. Handle carefully to prevent injury to fingers.

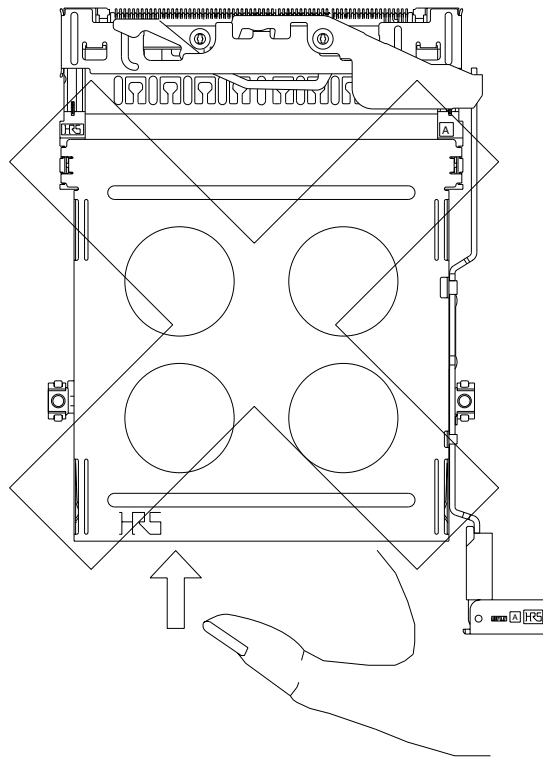

Do not tilt the card up or down a large amount while inserting it. Tilting the card could cause connector or card damage.

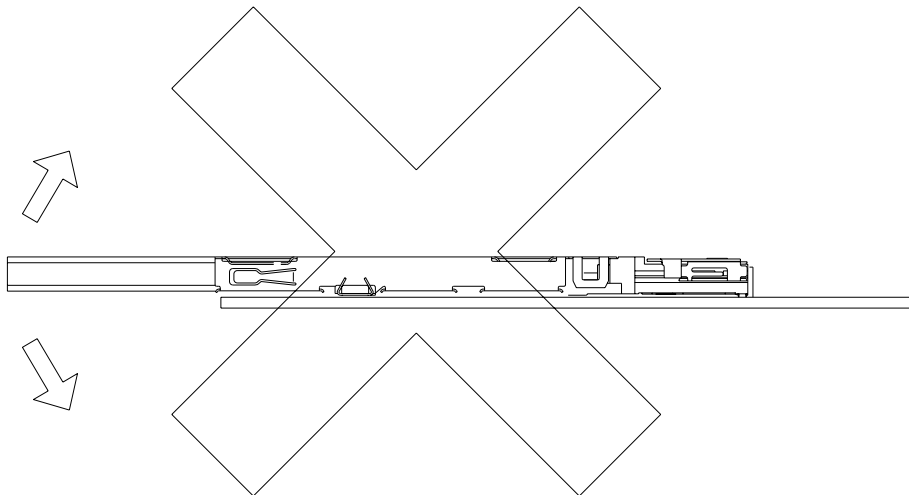

◆ Recommended temperature profile

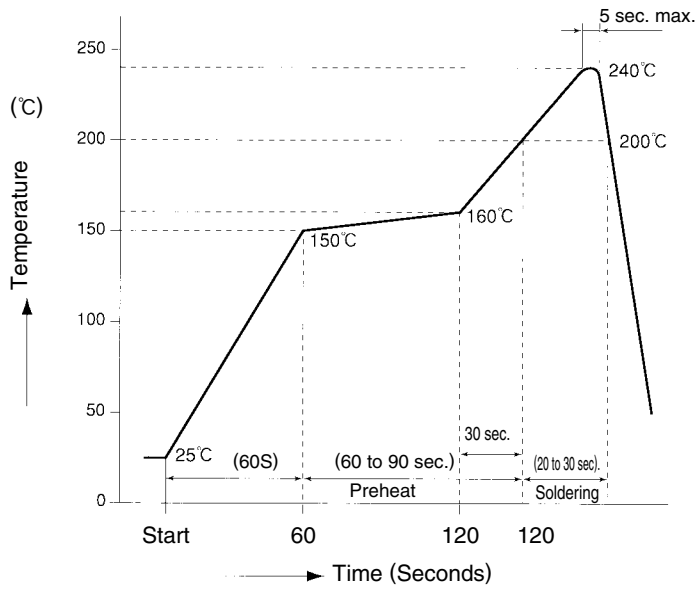

<Recommended conditions>

Reflow system	: IR reflow
Solder composition	: Paste, 63%Sn/37%Pb (Flux content 9wt%)
Test board	: Glass epoxy 80mm×125mm×1.6mm thick
Metal mask	: 0.15mm thick

The temperature profiles are based on the above conditions.

In individual applications the actual temperature may vary, depending on solder paste type, volume/thickness and board size/thickness. Consult your solder paste and equipment manufacturer for specific recommendations.



HIROSE ELECTRIC CO.,LTD.

5-23,OSAKI 5-CHOME,SHINAGAWA-KU,TOKYO 141-8587,JAPAN
PHONE: 81-3-3491-9741, FAX: 81-3-3493-2933
<http://www.hirose.com>
<http://www.hirose-connectors.com>