

2mm Hard Metric Connector

PCN21 Series

IEC 61076-4-101-compliant

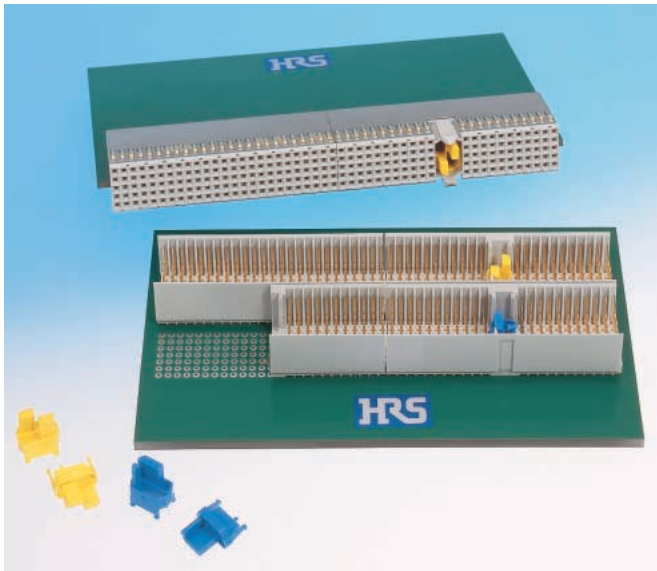

Applications

Switchboards, transmission systems, Cellular base stations, industrial computer boards, measuring instruments, control equipment

Features

1. Variety of styles

IEC Styles: A (110 contacts, 5 row), B (125 contacts, 5 row), C (55 contacts, 5 row), D (176 contacts, 8 row), E (200 contacts, 8 row) and M (5 row + 3 coaxial or power contacts).

Compact PCI styles: P2/J2 (110 contacts), P3/J3 (95 contacts) and Type AB (125 contacts).

2. Compliant press-fit board connection

Headers and receptacles with the compliant press-fit terminations can be easily installed on PCB with readily available tools.

3. High reliability socket contacts

Two-point contacts assure good electrical and mechanical connection.

4. Ground connection

Ground connection contact rows can be added (except M Style).

5. 3-stage sequential contacts

Header can be supplied with different lengths of contacts (mating side) to assure ground-signal-power mating sequence.

6. Coding keys

Style A, D and M will accept coding keys to prevent mating of incorrect connectors.

7. Different platings are available



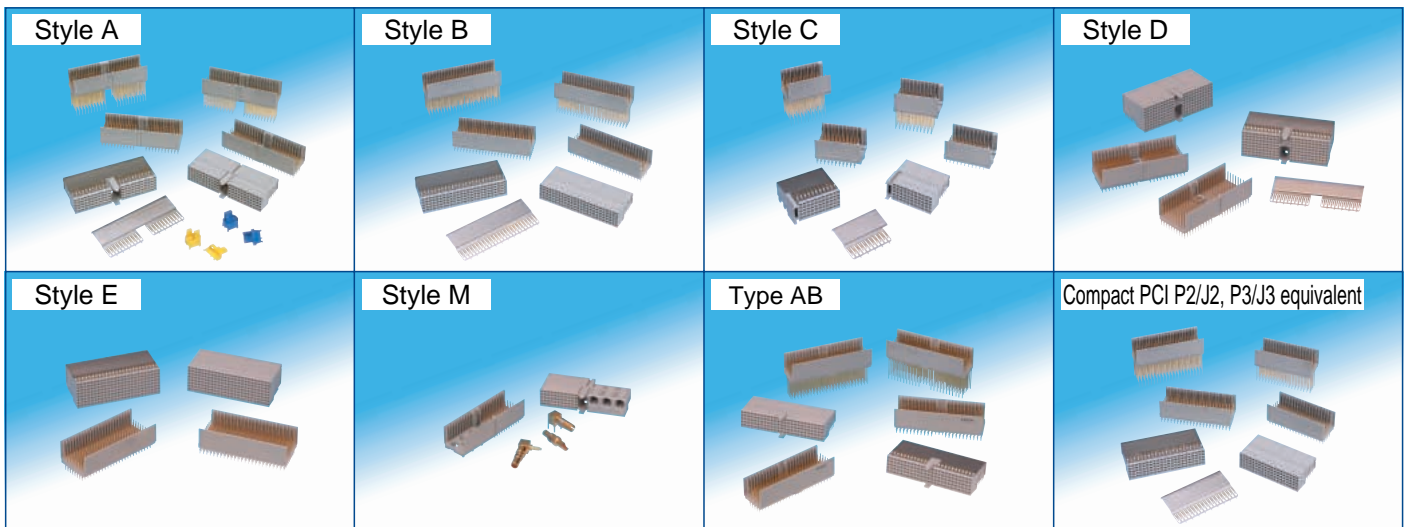

Gold plating and tin plating are available for the termination side. (Except 8 rows type)

8. Coding key



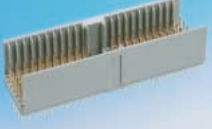
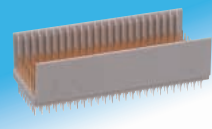



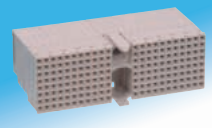







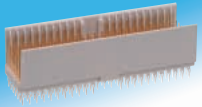





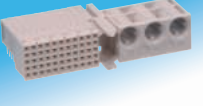

UL listed (File E52653)

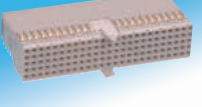

■PCN21 Series Seletion Chart

Standards		IEC 61076-4-101 compliant						
		Style A	Style B	Style C	Style D	Style E		
Header connector (Back Wiring Board side (BWB) male connector)	Short pin type	Without ground terminal	 P6 PCN21*-110PA-2PF	 P7 PCN21*-125PB-2PF	 P8 PCN21*-55PC-2PF	 P9 PCN21B-176PD-2PF	 P10 PCN21B-200PE-2PF	
		With ground terminal	 P6 PCN21*-110PA-2PF-G	 P7 PCN21*-125PB-2PF-G	 P8 PCN21*-55PC-2PF-G	 P9 PCN21B-176PD-2PF-G	 P10 PCN21B-200PE-2PF-G	
	Long pin type	Without ground terminal	 P6 PCN21*-110PA-2W	 P7 PCN21*-125PB-2W	 P8 PCN21*-55PC-2W			
		With ground terminal	 P6 PCN21*-110PA-2W-G	 P7 PCN21*-125PB-2W-G	 P8 PCN21*-55PC-2W-G			
	Receptacle connector (Package side female connector)	Without ground plate	 P13 PCN21*-110SA-2PF	 P14 PCN21*-125SB-2PF	 P15 PCN21*-55SC-2PF	 P16 PCN21B-176SD-2PF	 P17 PCN21B-200SE-2PF	
		With ground plate	With top ground plate	 P13 PCN21*-110SA-2PF-G	 P14 PCN21*-125SB-2PF-G	 P15 PCN21*-55SC-2PF-G	 P16 PCN21B-176SD-2PF-G	 P17 PCN21B-200SE-2PF-G
			Bottom ground plate	 P20 PCN21*-SA-G	 P20 PCN21*-SB-G	 P20 PCN21*-SC-G	 P21 PCN21B-SD-G	 P21 PCN21B-SE-G

Note: ...A: PCB leads gold plated (top ground plate is tin-lead or tin plated, bottom ground plate is tin-lead plated). B...PCB leads tin plated Mid-plane (Shroud): Page 22 to 23, Coding key: Page 24, High power contact or coaxial connector: Page 25

IEC 61076-4-101 compliant Style M	Type AB	Compact PCI P2/J2 equivalent	Compact PCI P3/J3 equivalent
 PCN21*-55PM-2PF	 PCN21*-125PAB-2PF	 PCN21*-110PB-2PF	 PCN21*-95PB-2PF
	 PCN21*-125PAB-2PF-G	 PCN21*-110PB-2PF-G	 PCN21*-95PB-2PF-G
	 PCN21*-125PAB-2W	 PCN21*-110PB-2W	 PCN21*-95PB-2W
	 PCN21*-125PAB-2W-G	 PCN21*-110PB-2W-G	 PCN21*-95PB-2W-G
 PCN21*-55SM-2PF	 PCN21*-125SAB-2PF	 PCN21*-110SB-2PF	 PCN21*-95SB-2PF
	 PCN21*-125SAB-2PF-G	 PCN21*-110SB-2PF-G	 PCN21*-95SB-2PF-G
	 PCN21*-SA-G	 PCN21*-SB1-G	 PCN21*-SB2-G

Ordering information

Connector

PCN 2 1 * - * P A * - 2 PF - G (01)

①
②
③
④
⑤
⑥
⑦
⑧
⑨
⑩

<p>① Series name : PCN 21</p> <p>② A...PCB leads : Gold plated B...PCB leads : Tin plated</p> <p>③ No. of contacts : 55, 95, 110, 125,176,200</p> <p>④ Connector classification P: Pin header S: Receptacle</p> <p>⑤ IEC type A : IEC 61076-4-101 Style A B : IEC 61076-4-101 Style B C : IEC 61076-4-101 Style C D : IEC 61076-4-101 Style D E : IEC 61076-4-101 Style E M : IEC 61076-4-101 Style M AB : Compact PCI AB type equivalent (For Compact PCI P2/J2, P5/J5 equivalent,) the IEC type should be style B.</p>	<p>⑥ Positioning post (Applicable to receptacle styles A and C only) Blank : With A : Without</p> <p>⑦ Contact pitch: 2 mm</p> <p>⑧ Terminal length PF : Press-fit short pin W : Press-fit long pin</p> <p>⑨ Ground Blank : Without ground terminal G : With ground terminal</p> <p>⑩ Contact area gold plating thickness Blank : 0.8 μm (01) : 0.2 μm</p>
--	--

Bottom ground plate for receptacle

PCN 2 1 * - S A - G

①
②
③
④
⑤

<p>① Series name: PCN21</p> <p>② A...PCB leads : Gold plated B...PCB leads : Tin plated</p> <p>③ Connector classification S : For receptacle</p>	<p>④ Applicable connector A : for PCN21*-110SA-2PF-G B : for PCN21*-125SB-2PF-G C : for PCN21*-55SC-2PF-G D : for PCN21B-176SD-2PF-G E : for PCN21B-200SE-2PF-G B1: for PCN21*-110SB-2PF-G B2: for PCN21*- 95SB-2PF-G</p> <p>⑤ Ground</p>
--	---

Product construction (5 row)

Header

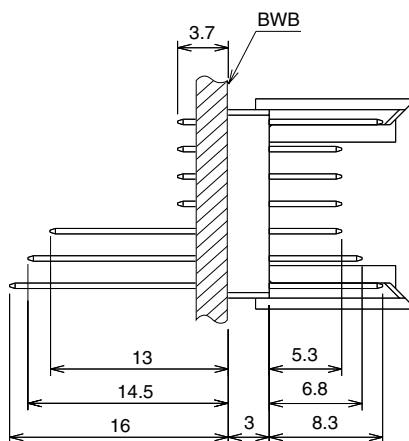

Rows f and z are ground terminals.
 PCN21*-*P*-2PF (W) has no ground terminal
 PCN21*-*P*-2PF (W)-G has ground terminal

Receptacle

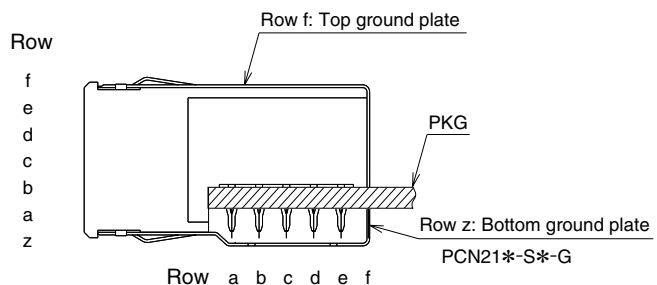

A ground plate is joined with the f row.

PCN21*-*S*-2PF has no top ground plate
 PCN21*-*S*-2PF-G has top ground plate
 PCN21*-S*-G has bottom ground plate only

■Product Specifications

Rating	Current rating	1.5A	Operating temperature	-55°C to +85°C(Note 1)	Storage temperature	-10°C to +60°C(Note 2)
	Voltage rating	AC 300V	Operating humidity	95% RH max. (No condensation)	Storage humidity	40% to 70% RH (Note 2)

Item	Requirements	Test Conditions
1.Insulation resistance	10 ⁴ MΩ	100 V DC
2.Withstanding voltage	No flashover or breakdown	750 V rms AC / 1 min
3.Contact resistance	30 mΩ max.	0.1 A
4.Vibration	No electrical discontinuity for 1μs min.	Frequency 10 to 500 Hz, single amplitude of 0.35 mm, acceleration of 50m/s ² , 10 cycles in each of the 3 axis.
5.Damp heat	Contact resistance: 40 mΩ max. Insulation resistance: 10 ³ MΩ min.	96 hours at temperature of 40°C ± 2°C and RH of 90% to 95%
6.Rapid change of temperature	Contact resistance:40 mΩ max. Insulation resistance: 10 ³ MΩ min. No damage, cracks or parts dislocation	Temperature : -55°C → +15°C to +30°C → +125°C → +15°C to +30°C Duration : 30 → 5max. → 30 → 5max.(Minutes) 5 cycles
7.Heat resistance	Contact resistance:40 mΩ max. Insulation resistance: 10 ³ MΩ min.	16 hours at temperature of 125°C
8.Operation life	Contact resistance:40 m ohms max.	500 cycles

Note 1: Includes temperature rise caused by the current flow.

Note 2: The term “storage” refers to products stored for long period of time prior to mounting and use. Operating temperature range and humidity range covers non-conducting condition of installed connectors in storage, shipment or during transportation.

■Materials / Finish

Product	Part	Material	Finish/color	Remarks
Header	Insulator	PBT	Gray	UL94V-0
	Terminal	Phosphor bronze	PCN21A Contact area : Nickel base, gold plated PCB leads : Nickel base, gold plated	—
PCN21B Contact area : Nickel base, gold plated PCB leads : Nickel base, tin plated				
Receptacle	Insulator	PBT	Gray	UL94V-0
	Terminal	Phosphor bronze	PCN21A Contact area : Nickel base, gold plated PCB leads : Nickel base, gold plated	—
			PCN21B Contact area : Nickel base, gold plated PCB leads : Nickel base, tin plated	
Shield	Phosphor bronze	PCN21A Contact area : Nickel base, gold plated Mounted area : Nickel base, tin lead plated PCN21B Contact area : Nickel base, gold plated PCB leads : Nickel base, tin plated	—	
Shroud	Insulator	PBT	Gray	UL94V-0
Coding key	Insulator	PBT	Refer to page 24	UL94V-0
Power contact	—	Brass, phosphor bronze	Nickel base, gold plated	—
Coaxial contact	Insulator	PTFE	White	—
	Outer conductor	Brass, phosphor bronze	Nickel base, gold plated	—
	Inner conductor	Phosphor bronze, beryllium copper	Nickel base, gold plated	—

Header (Style A) [Backplane side male connector, 5 row]

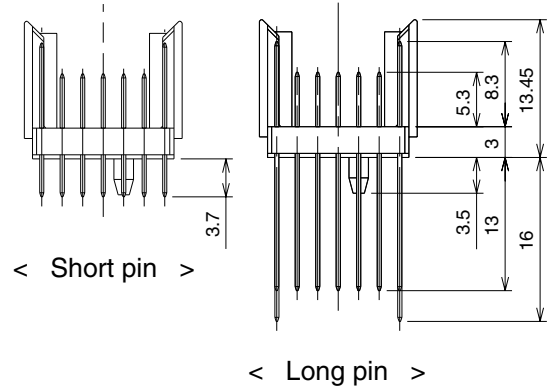
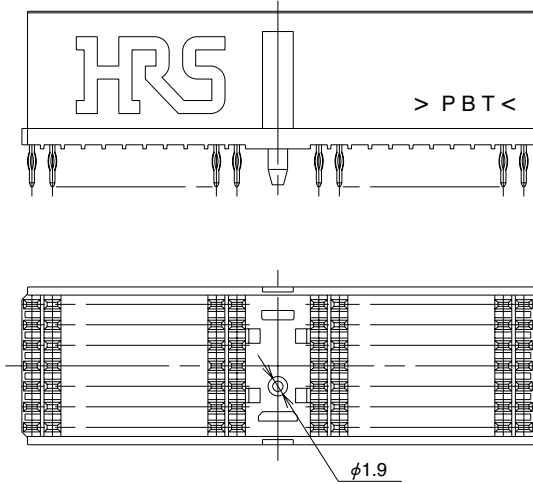
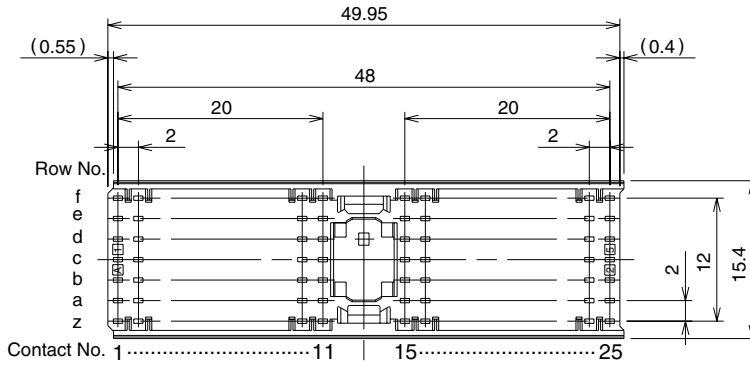

Recommended PCB mounting pattern

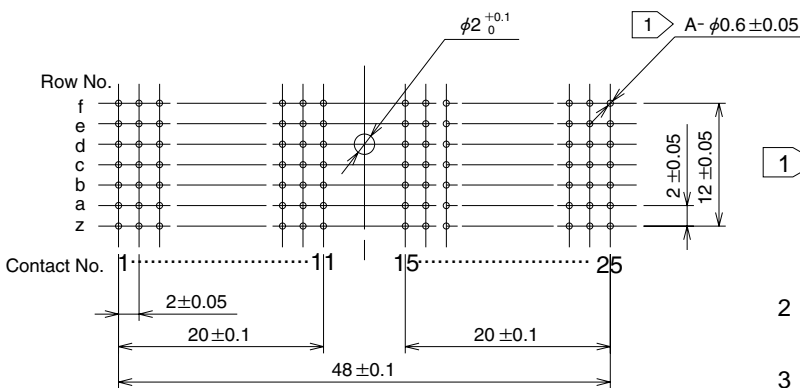

- 1 Plated through hole
 - Drilled diameter : $\phi 0.7 \pm 0.02$
 - Finished diameter : $\phi 0.6 \pm 0.05$
 - Plating : Cu 25 μ m
- 2 Without ground terminal types, row f and z are not needed.
- 3 Board thickness : 1.6 to 5.6 mm

Part number	A	No. of contacts	Mounting side
PCN21*-110PA-2PF	110	5	Short pin
PCN21*-110PA-2PF-G	154	7	
PCN21*-110PA-2W	110	5	Long pin
PCN21*-110PA-2W-G	154	7	

*A: PCB leads gold plated B: PCB leads tin plated

Header (Style B) [Backplane side male connector, 5 row]

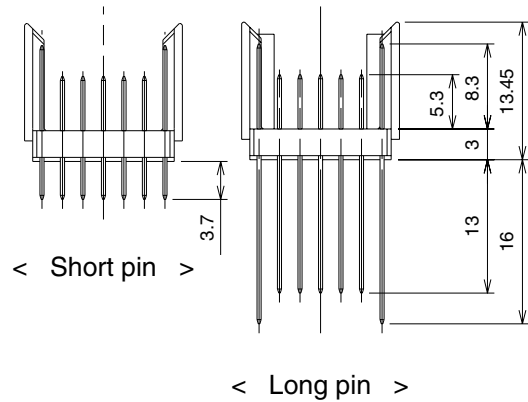
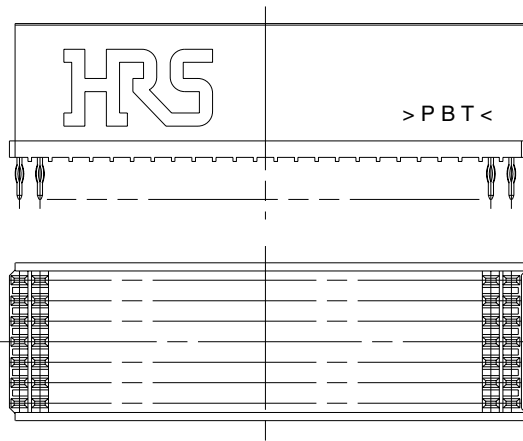
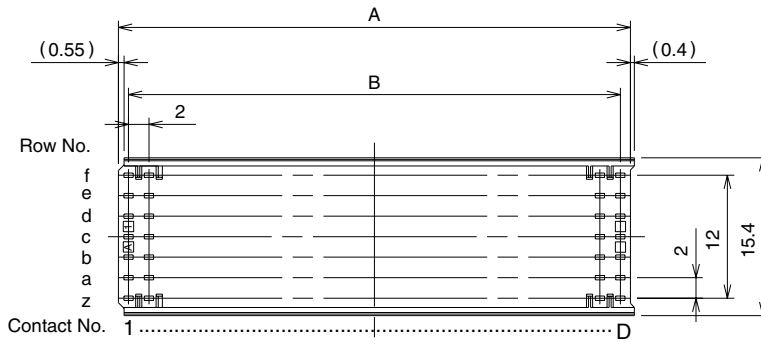

Recommended PCB mounting pattern

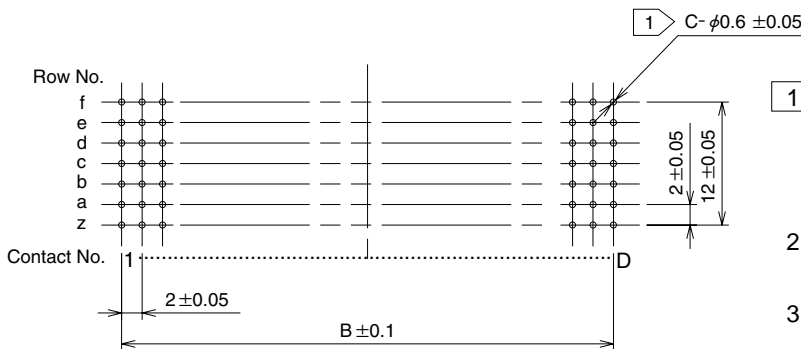

- 1 Plated through hole
 - Drilled diameter : $\phi 0.7 \pm 0.02$
 - Finished diameter : $\phi 0.6 \pm 0.05$
 - Plating : Cu 25 μ min
- 2 Without ground terminal types, row f and z are not needed.
- 3 Board thickness : 1.6 to 5.6 mm

Product No.	A	B	C	D	No. of contacts	Mounting side
PCN21*-125PB-2PF	49.95	48	125	25	5	Short pin
PCN21*-125PB-2PF-G	49.95	48	175	25	7	
PCN21*-110PB-2PF	49.95	42	110	22	5	
PCN21*-110PB-2PF-G	49.95	42	154	22	7	
PCN21*- 95PB-2PF	37.95	36	95	19	5	Long pin
PCN21*- 95PB-2PF-G	37.95	36	133	19	7	
PCN21*-125PB-2W	43.95	48	125	25	5	
PCN21*-125PB-2W-G	43.95	48	175	25	7	
PCN21*-110PB-2W	43.95	42	110	22	5	
PCN21*-110PB-2W-G	43.95	42	154	22	7	
PCN21*- 95PB-2W	37.95	36	95	19	5	
PCN21*- 95PB-2W-G	37.95	36	133	19	7	

*A: PCB leads gold plated B: PCB leads tin plated

Header (Style C) [Backplane side male connector, 5 row]

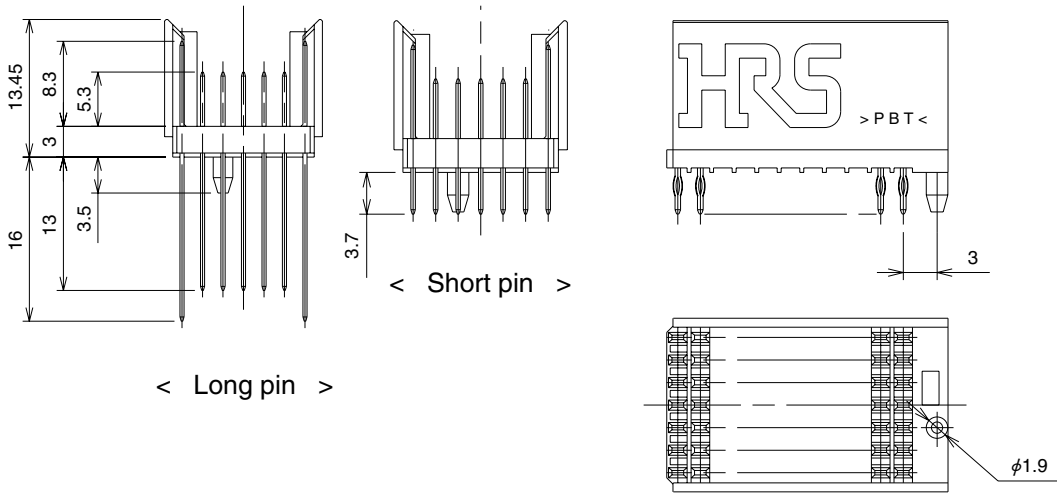
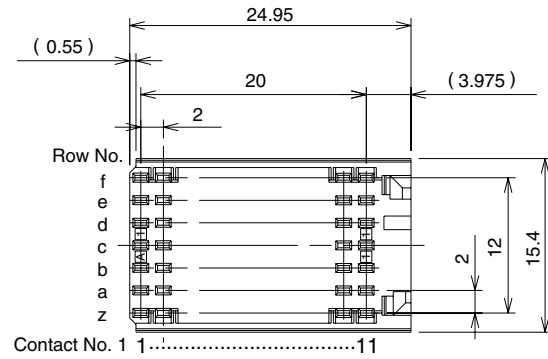

Recommended PCB mounting pattern

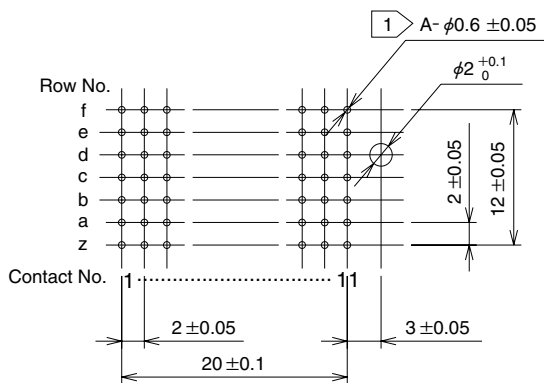

- 1 Plated through hole
 Drilled diameter : $\phi 0.7 \pm 0.02$
 Finished diameter : $\phi 0.6 \pm 0.05$
 Plating : Cu 25 μ min
- 2 Without ground terminal types, row f and z are not needed.
- 3 Board thickness : 1.6 to 5.6 mm

Part number .	A	No. of contacts	Mounting side
PCN21*-55PC-2PF	55	5	Short pin
PCN21*-55PC-2PF-G	77	7	
PCN21*-55PC-2W	55	5	Long pin
PCN21*-55PC-2W-G	77	7	

*A: PCB leads gold plated B: PCB leads tin plated

■Header (Style D) [Backplane side male connector, 8 row]

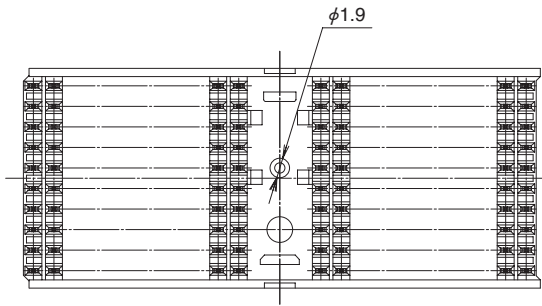
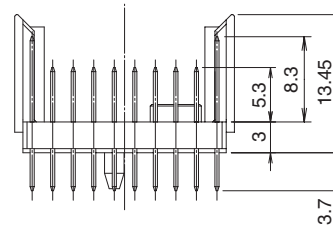
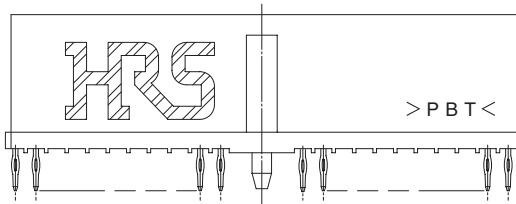
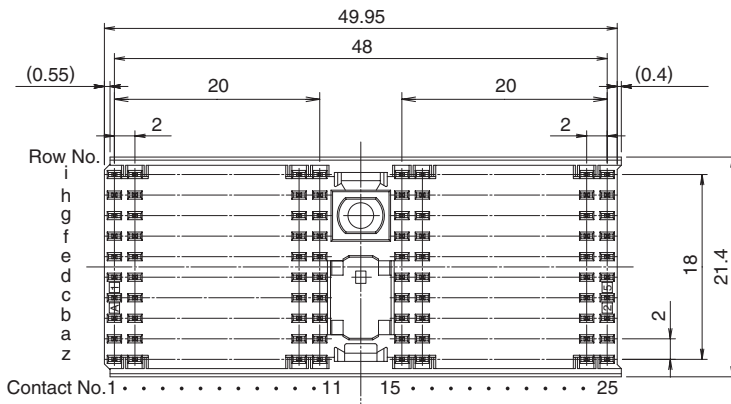

◆Recommended PCB mounting pattern

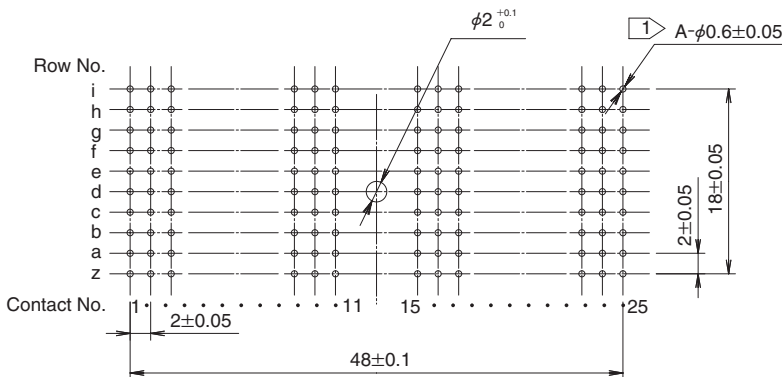

- 1 Plated through hole
 Drilled diameter : $\phi 0.7 \pm 0.02$
 Finished diameter : $\phi 0.6 \pm 0.05$
 Plating : Cu 25 μ m
- 2 Without ground terminal types,
 row i and z are not needed.
- 3 Board thickness : 1.6 to 5.6 mm

Part number	A	No. of contacts	Mounting side
PCN21B-176PD-2PF	176	8	Short pin
PCN21B-176PD-2PF-G	220	10	

■ Header (Style E) [Backplane side male connector, 8 row]

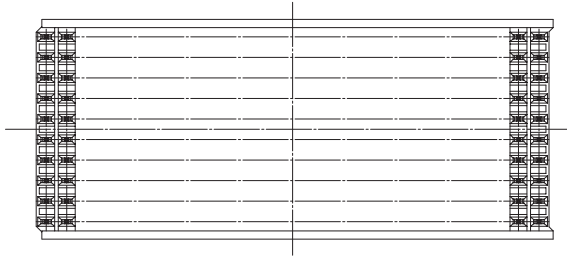
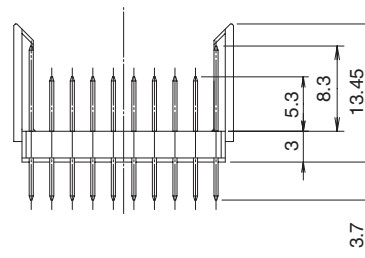
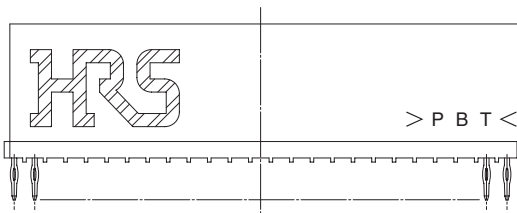
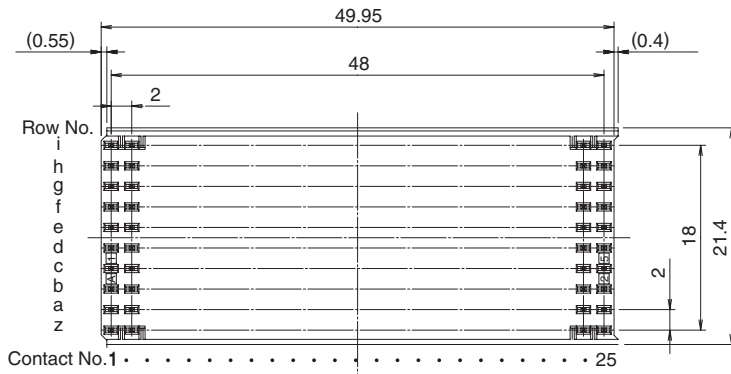

◆ Recommended PCB mounting pattern

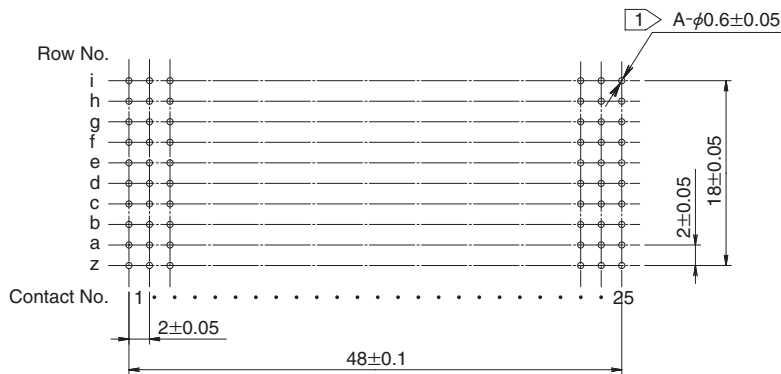

- 1 Plated through hole
 Drilled diameter : φ0.7 ± 0.02
 Finished diameter : φ0.6 ± 0.05
 Plating : Cu 25 μm
- 2 Without ground terminal types,
 row i and z are not needed.
- 3 Board thickness : 1.6 to 5.6 mm

Part number	A	No. of contacts	Mounting side
PCN21B-200PE-2PF	200	8	Short pin
PCN21B-200PE-2PF-G	250	10	

Header (Style M) [Backplane side connector, 5 row]

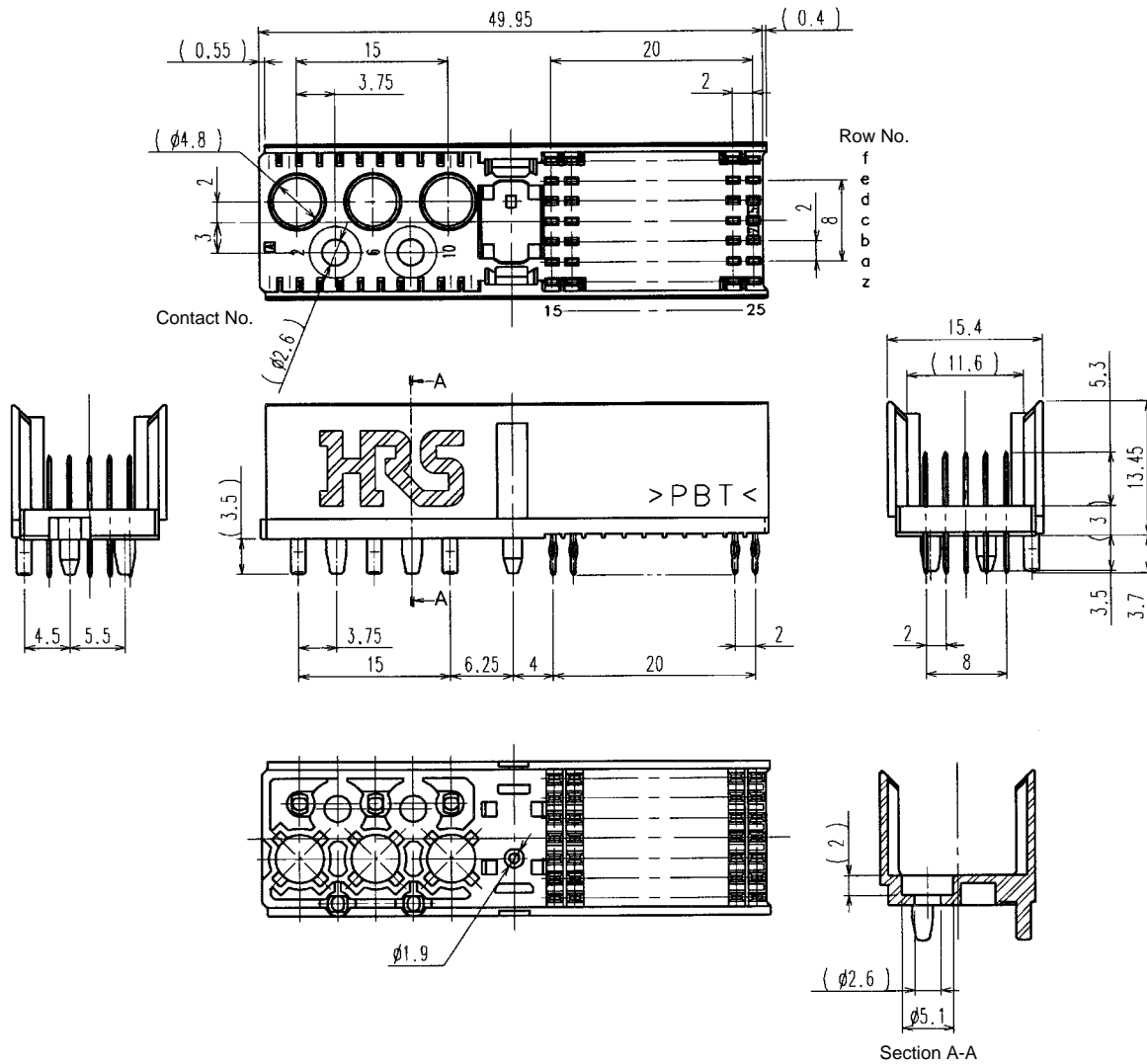

Recommended PCB mounting pattern

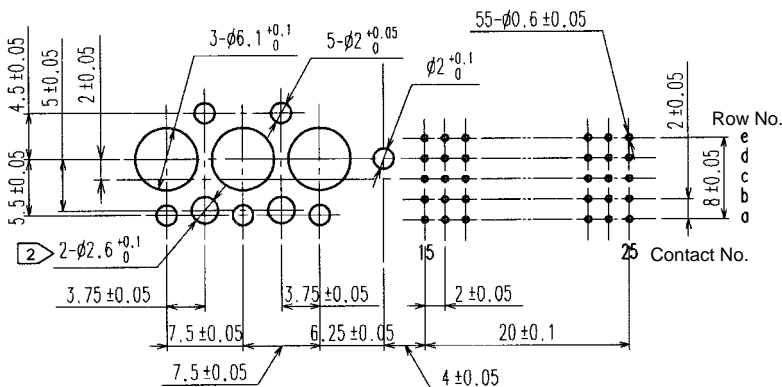

- 1 Plated through hole
 Drilled diameter : $\phi 0.7 \pm 0.02$
 Finished diameter : $\phi 0.6 \pm 0.05$
 Plating : Cu 25 μ min
- 2 Optional for screw clamp
- 3 Board thickness : 1.6 to 5.6mm

Part number	No. of contacts	Mounting side
PCN21*-55PM-2PF	5	Short Pin

*A: PCB leads gold plated B: PCB leads tin plated

■Header (Type AB) [Backplane side male connector, 5 row]

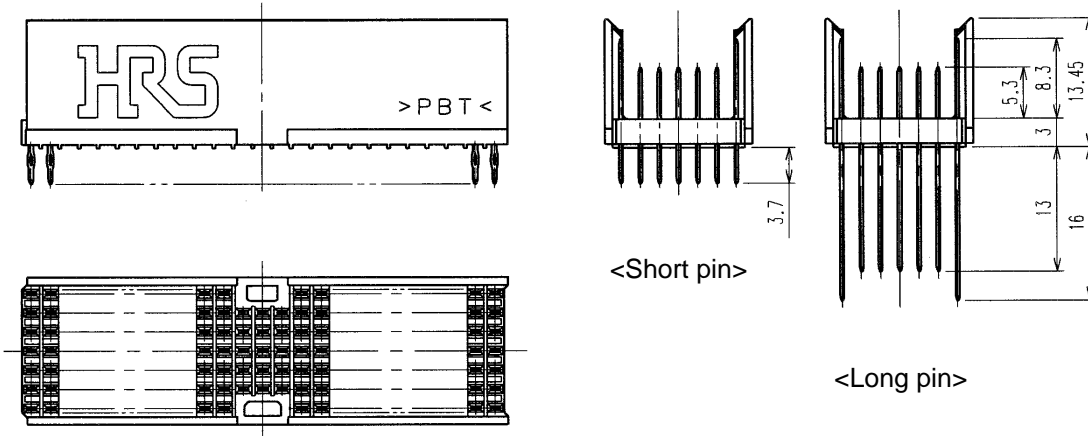
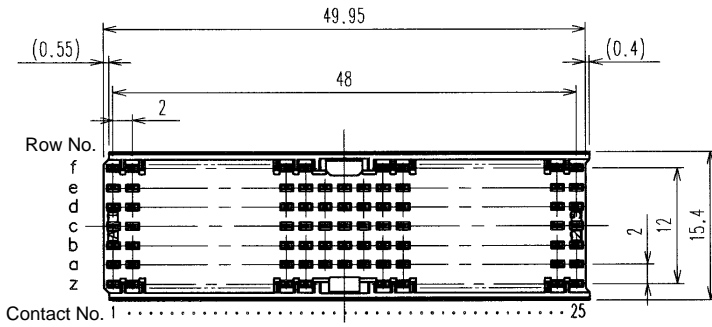

◆Recommended PCB mounting pattern

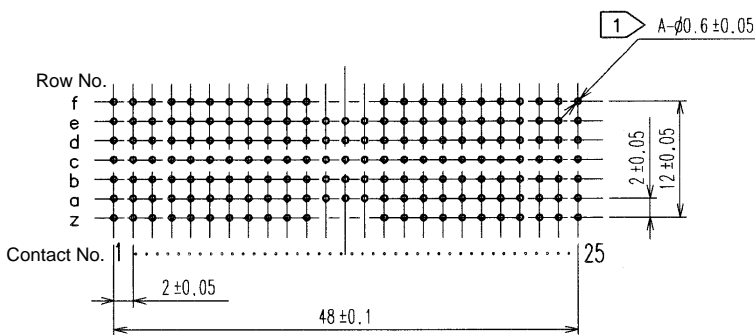

- 1 Plated through hole
 Drilled diameter : $\phi 0.7 \pm 0.02$
 Finished diameter : $\phi 0.6 \pm 0.05$
 Plating : Cu 25 μ min
- 2 Without ground terminal types,
 row f and z are not needed.
- 3 Board thickness : 1.6 to 5.6 mm

Part number	A	No. of contacts	Mounting side
PCN21*-125PAB-2PF	125	5	Short Pin
PCN21*-125PAB-2PF-G	169	7	
PCN21*-125PAB-2W	125	5	Long Pin
PCN21*-125PAB-2W-G	169	7	

*A: PCB leads gold plated B: PCB leads tin plated

■ Receptacle (Style A) [Package side female connector, 5 row]

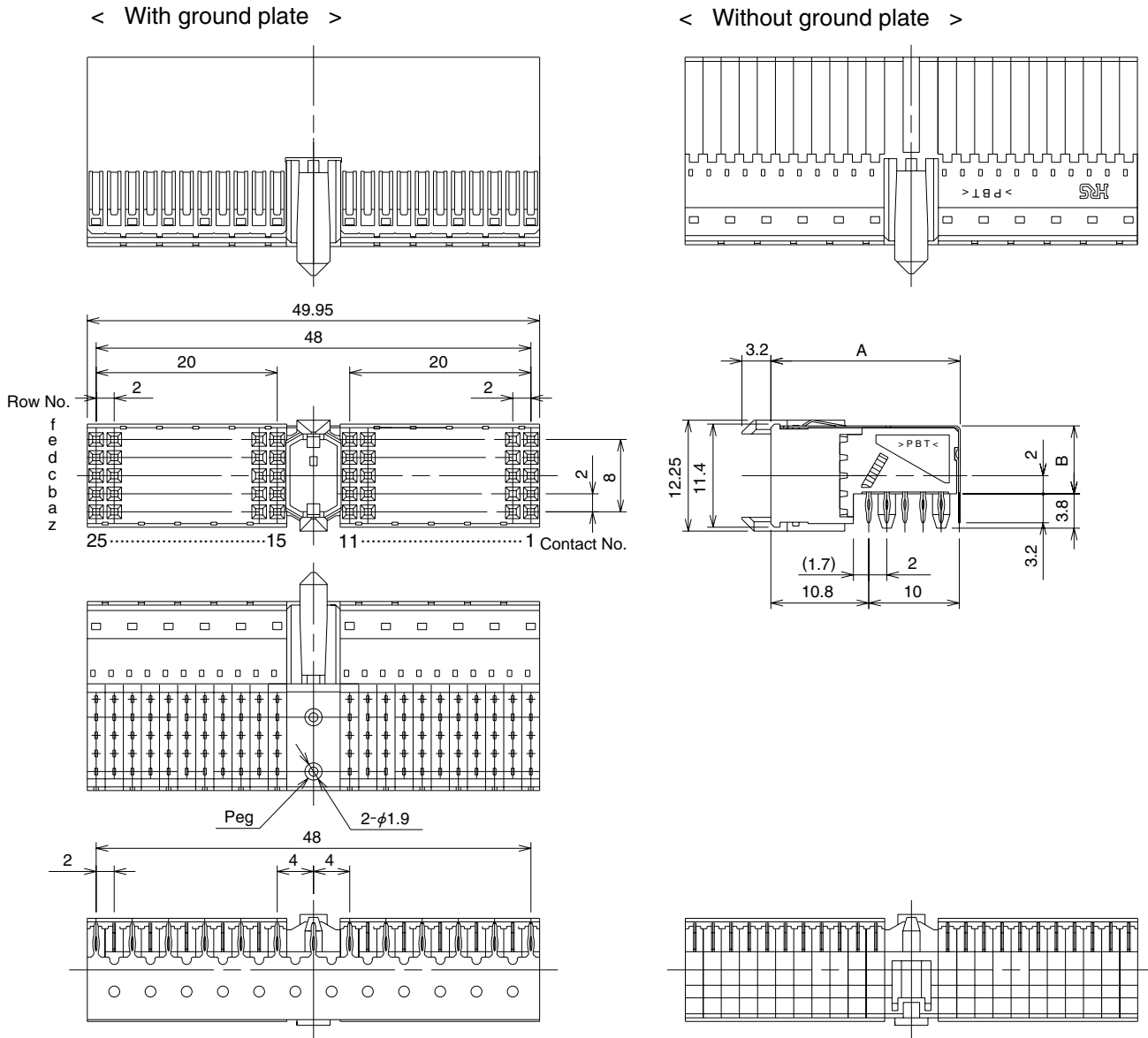

◆ Recommended PCB mounting pattern

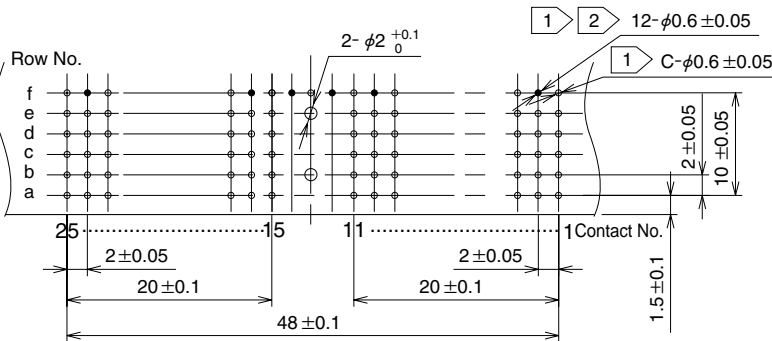

- 1 Plated through hole
 Drilled diameter : $\phi 0.7 \pm 0.02$
 Finished diameter : $\phi 0.6 \pm 0.05$
 Plating : Cu 25 μ m
- 2 Even numbers are required on the f row when using the lower surface ground plate (PCN21*-SA-G).
- 3 Without ground terminal types, row f are not needed.
- 4 The type without the post does not require the 2mm dia. hole.
- 5 Board thickness: 1.6 to 4.2 mm

Part number	A	B	C	Ground plate	Post
PCN21*-110SA-2PF	20.7	7.3	110	Without	With
PCN21*-110SA-2PF-G	20.9	7.5	123	With	
PCN21*-110SAA-2PF	20.7	7.3	110	Without	Without
PCN21*-110SAA-2PF-G	20.9	7.5	123	With	

*A: PCB leads gold plated (Ground plate mounting area : tin plated) B: PCB leads tin plated

■ Receptacle (Style B) [Package side female connector, 5 row]

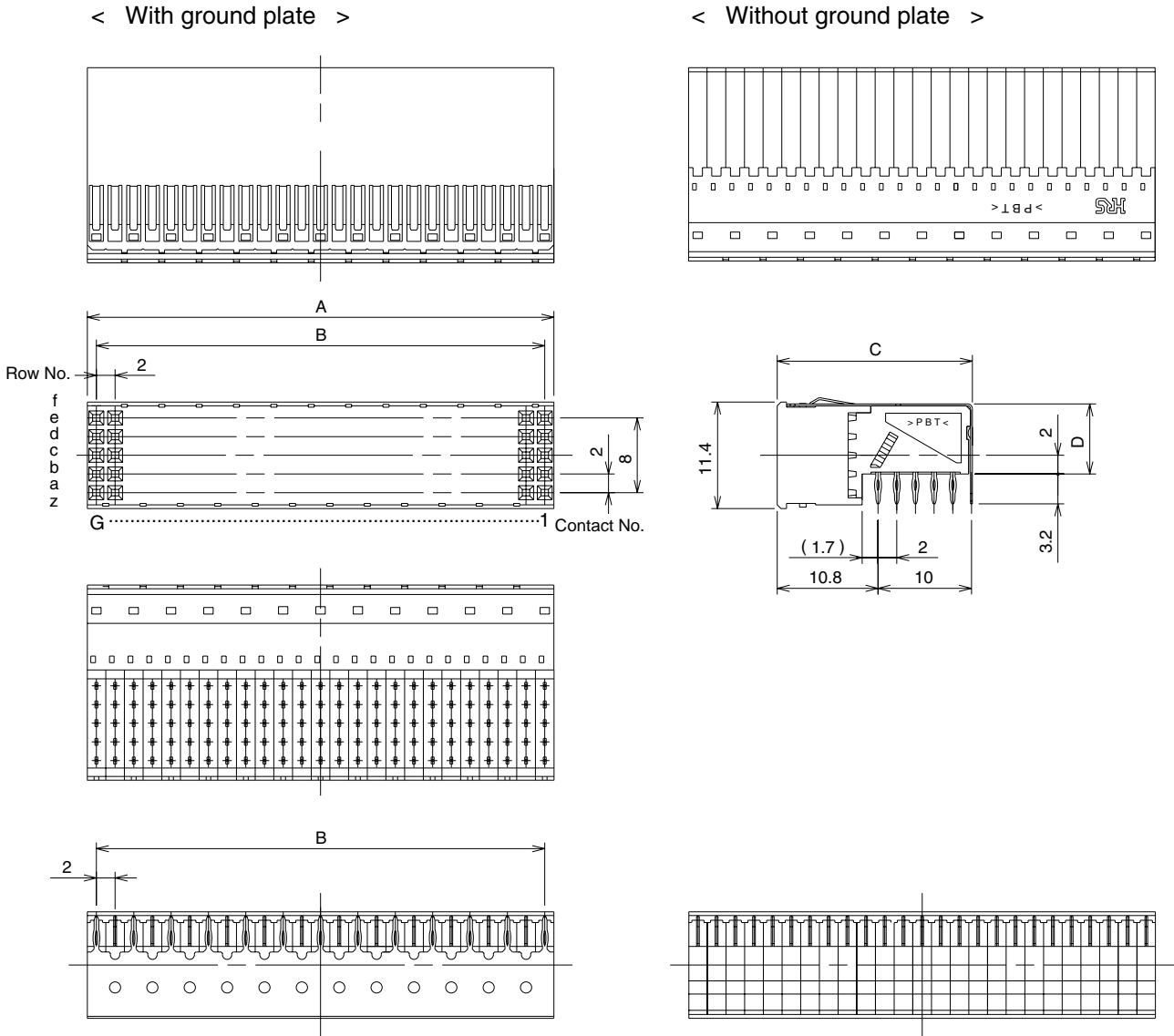

◆ Recommended PCB mounting pattern

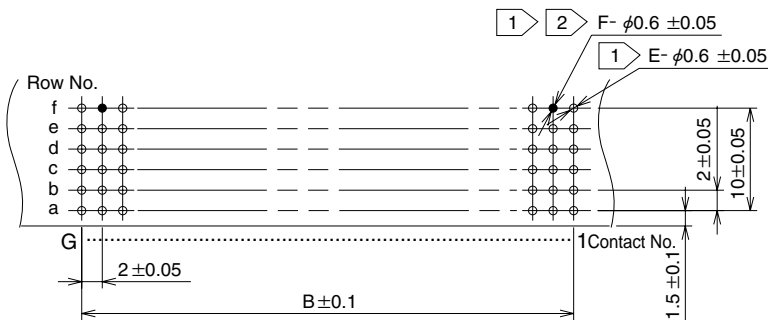

- 1 Plated through hole
 Drilled diameter : $\phi 0.7 \pm 0.02$
 Finished diameter : $\phi 0.6 \pm 0.05$
 Plating : Cu $25 \mu\text{min}$
- 2 Even numbers are required on the f row when using the lower surface ground plate (PCN21*-SB-G).
- 3 Without ground terminal types, row f are not needed.
- 4 Board thickness: 1.6 to 4.2 mm

Part number	A	B	C	D	E	F	G	Ground plate
PCN21*-125SB-2PF	49.95	48	20.7	7.3	125	-	25	Without
PCN21*-125SB-2PF-G	49.95	48	20.9	7.5	138	12	25	With
PCN21*-110SB-2PF	43.95	42	20.7	7.3	110	-	22	Without
PCN21*-110SB-2PF-G	43.95	42	20.9	7.5	121	11	22	With
PCN21*- 95SB-2PF	37.95	36	20.7	7.3	95	-	19	Without
PCN21*- 95SB-2PF-G	37.95	36	20.9	7.5	105	9	19	With

*A: PCB leads gold plated (Ground plate mounting area : tin plated) B: PCB leads tin plated

■ Receptacle (Style C) [Package side female connector, 5 row]

< With ground plate >

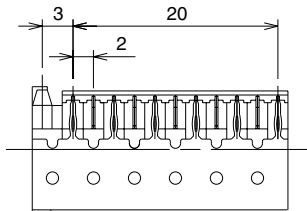
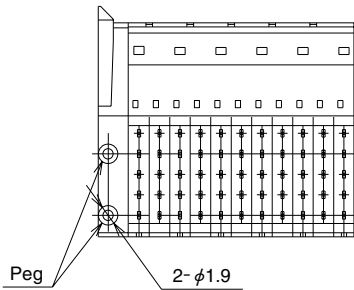
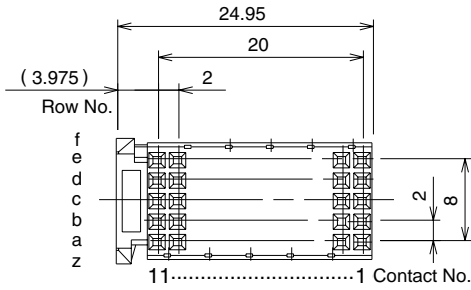
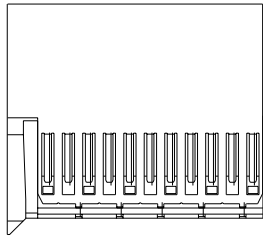

< Without ground plate >

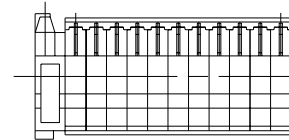
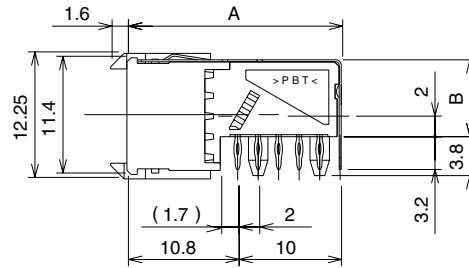
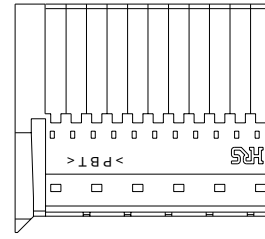

◆ Recommended PCB mounting pattern

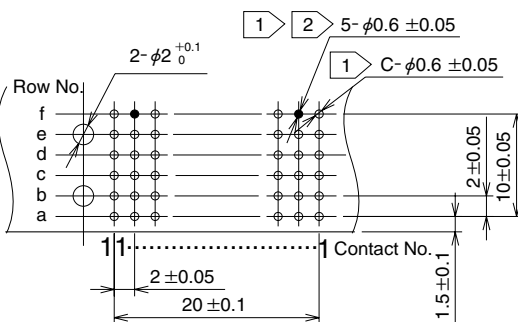

- 1 Plated through hole
 Drilled diameter : $\phi 0.7 \pm 0.02$
 Finished diameter : $\phi 0.6 \pm 0.05$
 Plating : Cu 25 μ m
- 2 Even numbers are required on the f row when using the lower surface ground plate (PCN21*-SC-G).
- 3 Without ground terminal types, row f are not needed.
- 4 The type without the post does not require the 2mm dia. hole.
- 5 Board thickness: 1.6 to 4.2 mm

Part number	A	B	C	Ground plate	Post
PCN21*-55SC-2PF	20.7	7.3	55	Without	With
PCN21*-55SC-2PF-G	20.9	7.5	61	With	With
PCN21*-55SCA-2PF	20.7	7.3	55	Without	Without
PCN21*-55SCA-2PF-G	20.9	7.5	61	With	Without

*A: PCB leads gold plated (Ground plate mounting area : tin plated) B: PCB leads tin plated

■ Receptacle (Style D) [Package side female connector, 8 row]

<With ground plate>

<Without ground plate>

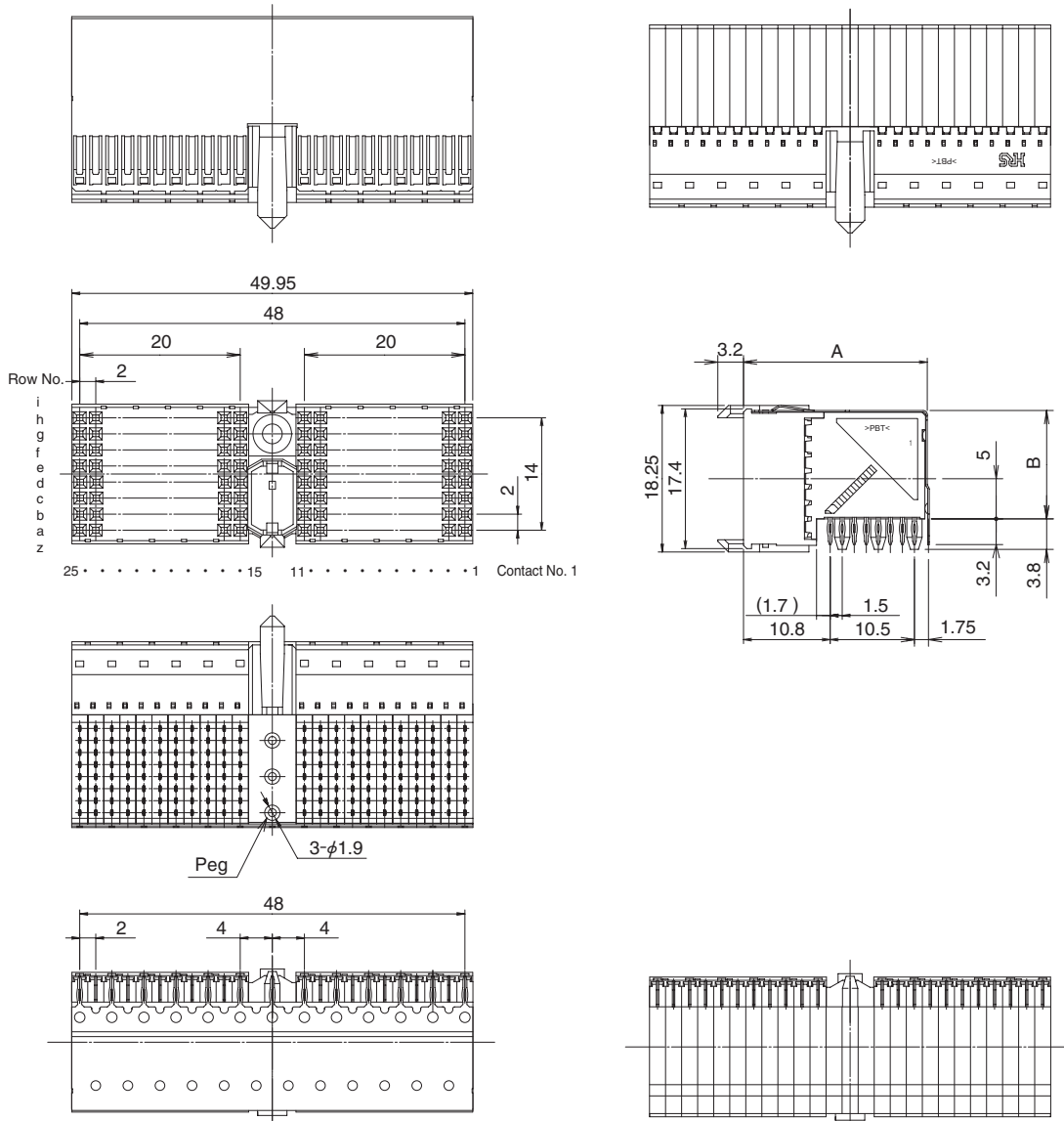

◆ Recommended PCB mounting pattern

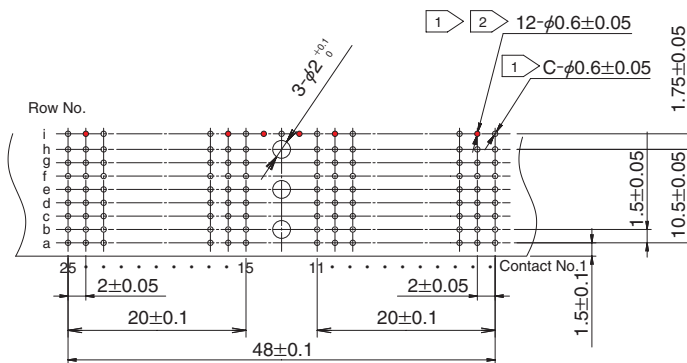

- 1 Plated through hole
 Drilled diameter : $\phi 0.7 \pm 0.02$
 Finished diameter : $\phi 0.6 \pm 0.05$
 Plating : Cu 25 μ m
- 2 Even numbers are required on the i row when using the low surface ground plate (PCN21B-SE-G).
- 3 Without ground plate types, row i not needed.
- 4 Board thickness: 1.6 to 4.2mm

Part number	A	B	C	Ground plate
Through hole	22.7	13.3	176	Without
PCN21B-176SD-2PF-G	23.15	13.5	189	With

■ Receptacle (Style E) [Package side female connector, 8 row]

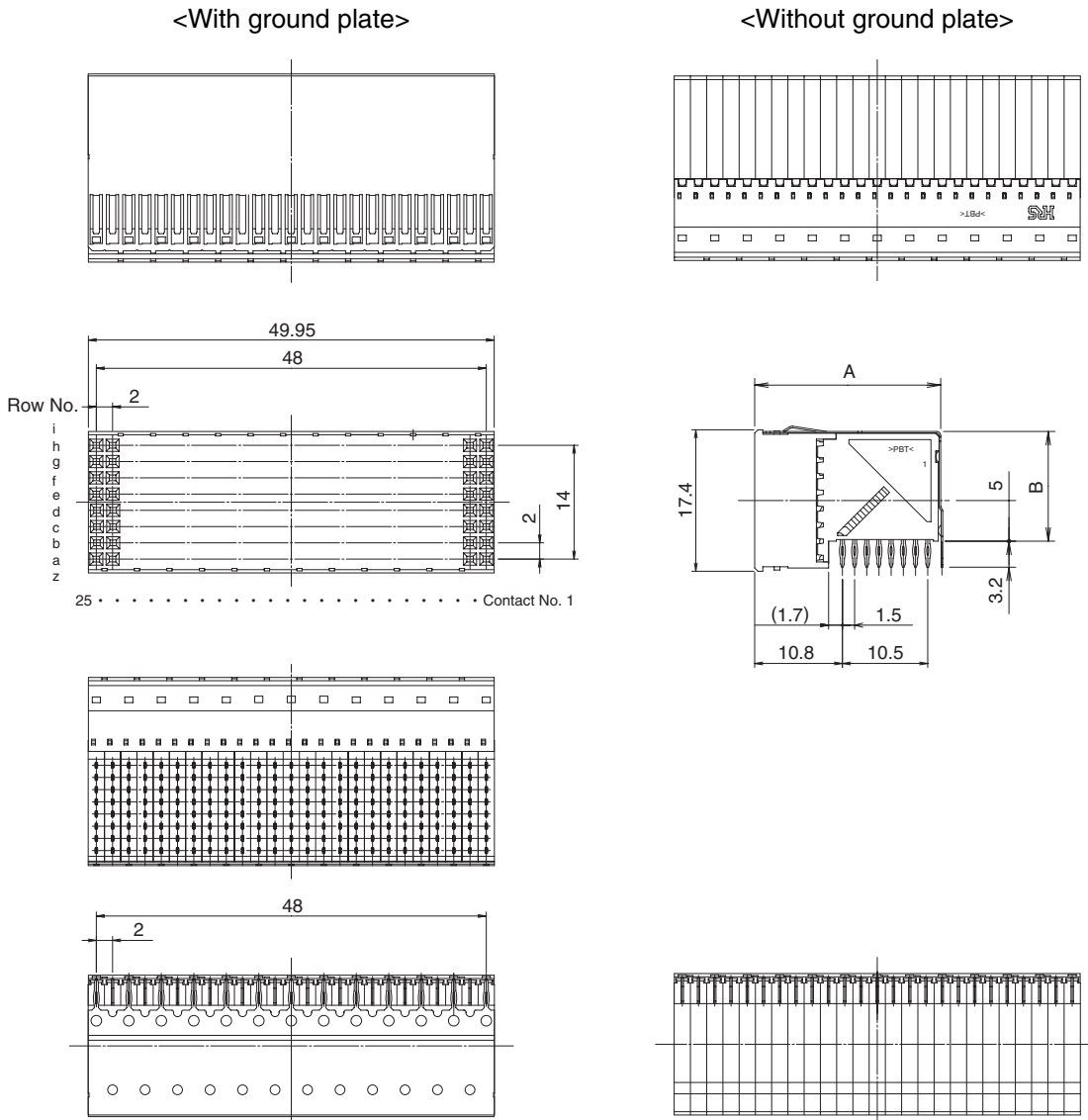

◆ Recommended PCB mounting pattern

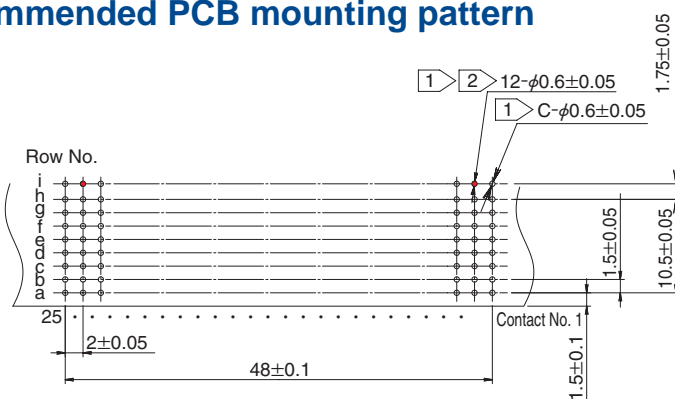

- 1 Plated through hole
 - Drilled diameter : $\phi 0.7 \pm 0.02$
 - Finished diameter : $\phi 0.6 \pm 0.05$
 - Plating : Cu 25 μ min
- 2 Even numbers are required on the i row when using the low surface ground plate (PCN21B-SE-G).
- 3 Without ground plate types, row i not needed.
- 4 Board thickness: 1.6 to 4.2mm

Part number	A	B	C	Ground plate
PCN21B-200SE-2PF	22.7	13.3	200	Without
PCN21B-200SE-2PF-G	23.15	13.5	213	With

■ Receptacle (Style M) [Package side female connector, 5 row]

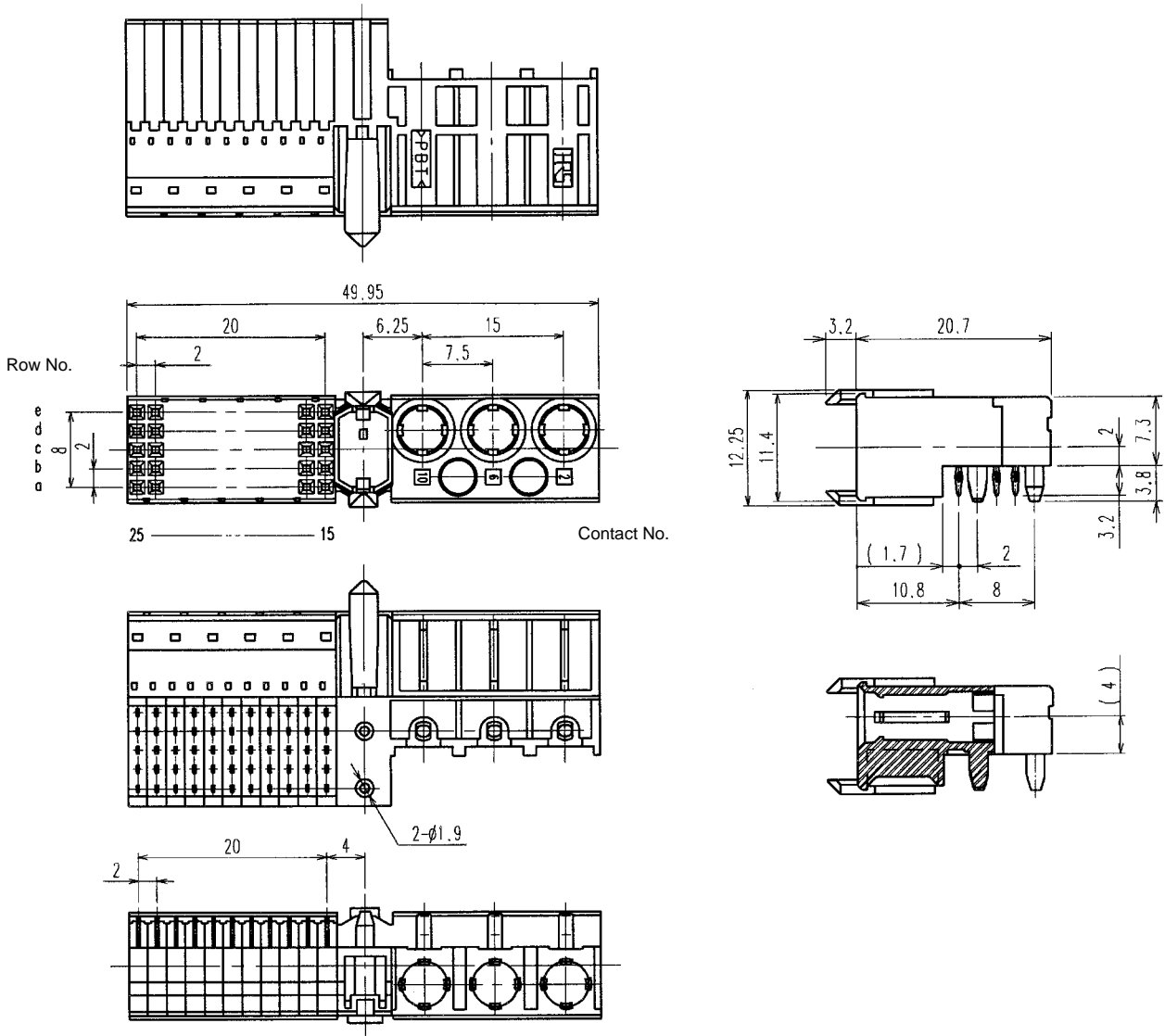

◆ Recommended PCB mounting pattern

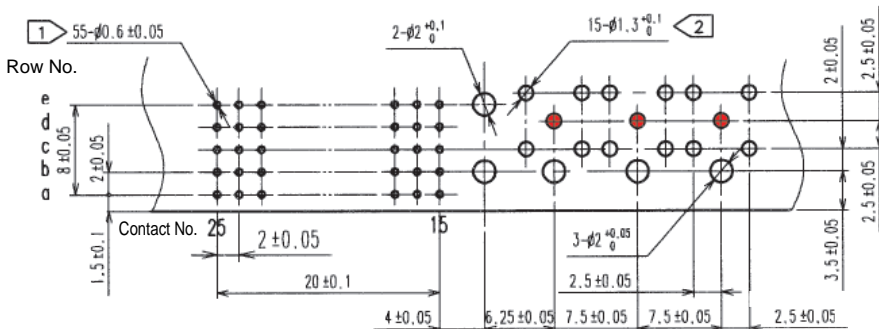

- 1 Plated through hole
 Drilled diameter : $\phi 0.7 \pm 0.02$
 Finished diameter : $\phi 0.6 \pm 0.05$
 Plating : Cu 25 μ m
- 2 Optional for high power contact (PCN21-S-PWR(PC)) and coaxial connector (PO51M-LPR-PC-1A).
 High power contact type, hole ● not needed.
- 3 Board thickness: 1.6 to 4.2 mm

Part number.	Ground plate	Post
PCN21*-55SM-2PF	Without	With

*A: PCB leads gold plated B: PCB leads tin plated

■ Receptacle (Type AB) [Package side female connector, 5 row]

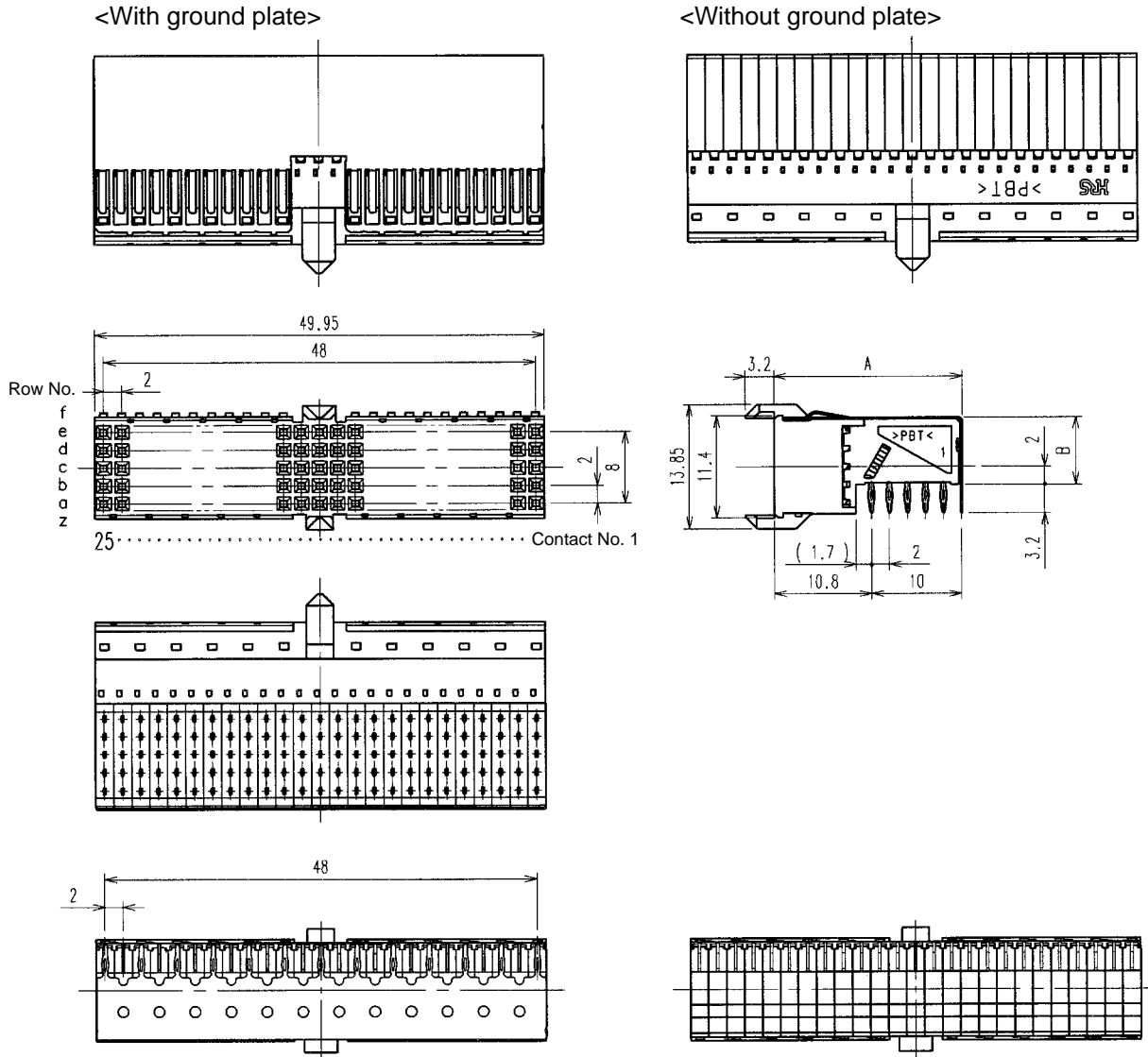

◆ Recommended PCB mounting pattern

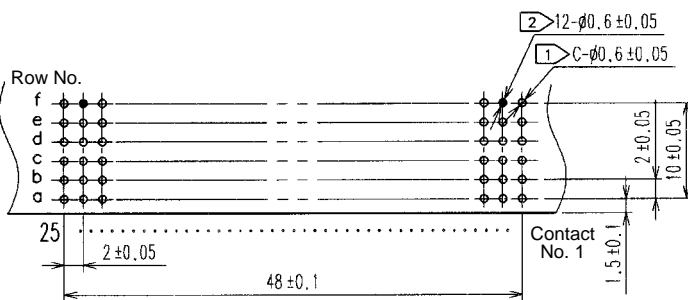

- 1) plated through hole
 Drilled diameter : $\phi 0.7 \pm 0.02$
 Finished diameter : $\phi 0.6 \pm 0.05$
 Plating : Cu 25 μ m
- 2) Even numbers are required on the f row when using the lower surface ground plate (PCN21*-SA-G).
- 3) Without ground the plate types, rows f not needed.
- 4) Board thickness: 1.6 to 4.2 mm

Part number.	A	B	C	Ground plate
PCN21*-125SAB-2PF	20.7	7.3	125	Without
PCN21*-125SAB-2PF-G	20.9	7.5	138	With

*A: PCB leads gold plated (Ground plate mounting area : tin plated) B: PCB leads tin plated

Bottom ground plates for receptacles

PCN21*-SA-G

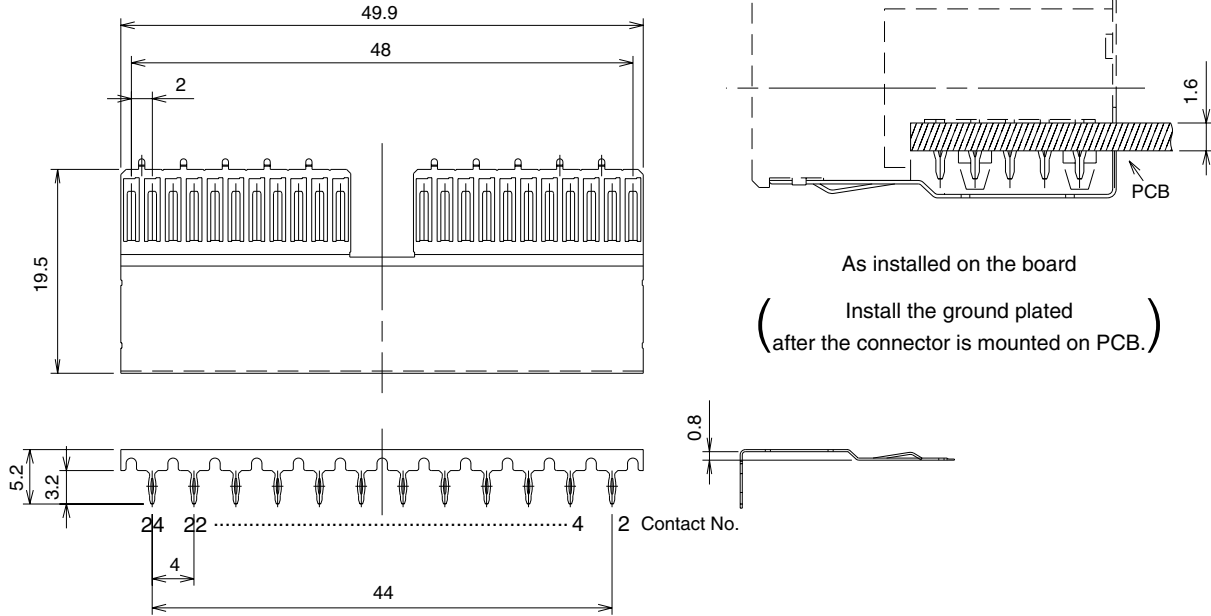

PCN21*-SB-G
 PCN21*-SB1-G
 PCN21*-SB2-G

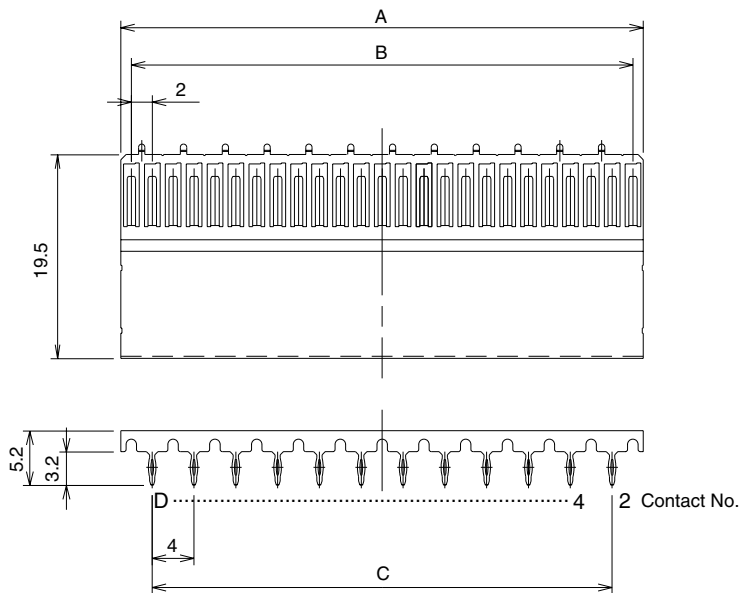

PCN21*-SC-G

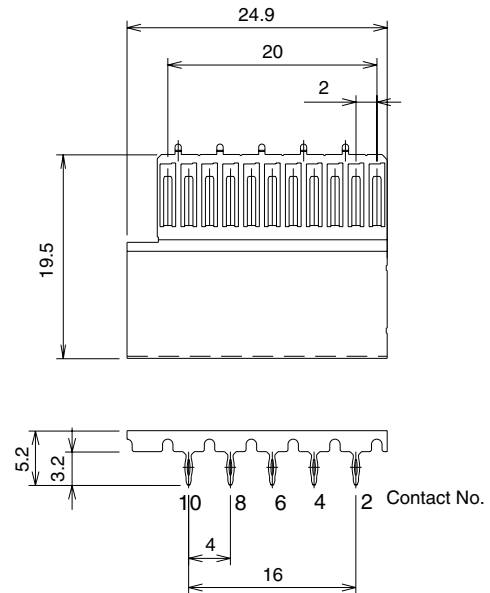

Product No.	A	B	C	D	Applicable connector
PCN21*-SA-G	—	—	—	—	PCN21*-110SA-2PF-G
PCN21*-SB-G	49.9	48	44	24	PCN21*-125SB-2PF-G
PCN21*-SB1-G	43.9	42	40	22	PCN21*-110SB-2PF-G
PCN21*-SB2-G	37.9	36	32	18	PCN21*- 95SB-2PF-G
PCN21*-SC-G	—	—	—	—	PCN21*- 55SC-2PF-G

*A: PCB leads gold plated B: PCB leads tin plated

PCN21B-SD-G

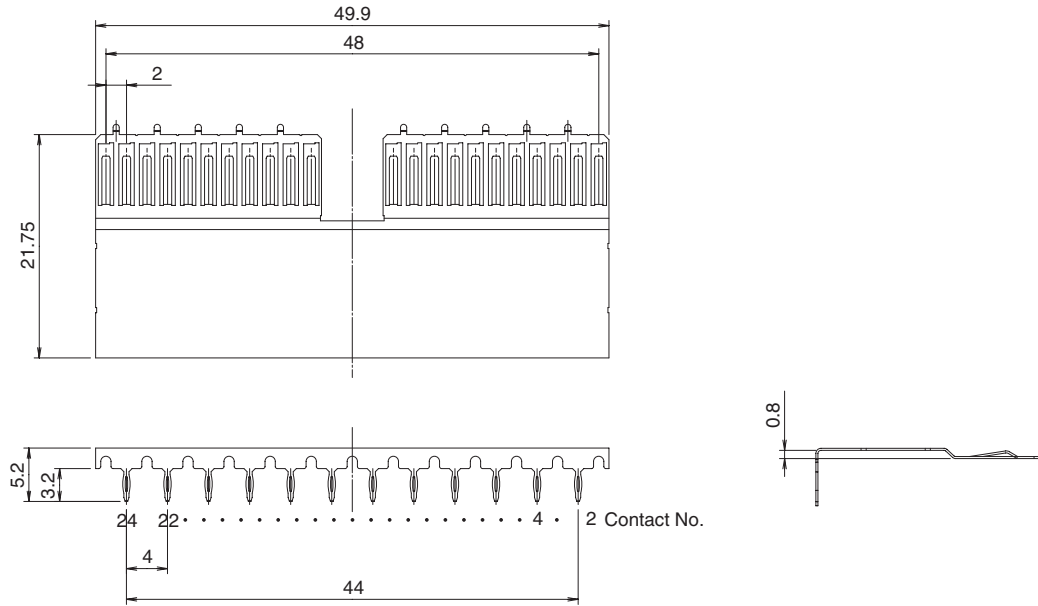

PCN21B-SE-G

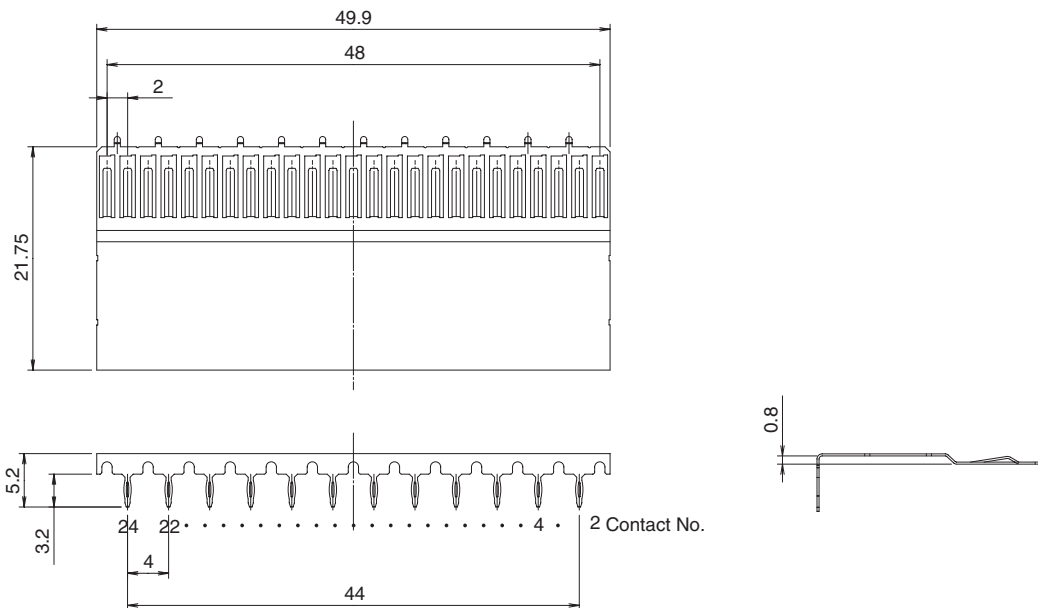

Product No.	Applicable connector
PCN21B-SD-G	PCN21B-176SD-2PF-G
PCN21B-SE-G	PCN21B-200SE-2PF-G

■Mid-plane (Shroud) [Style A]

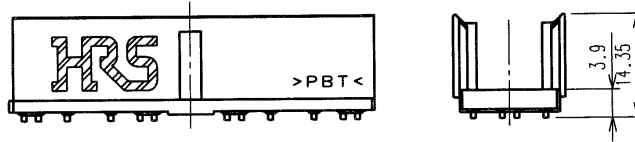
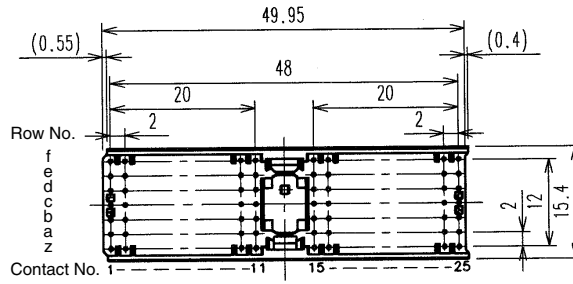

[Style B]

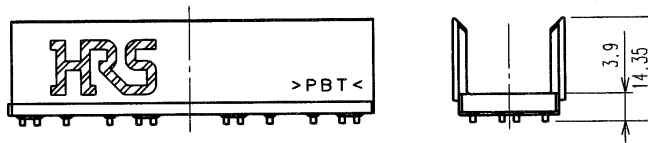
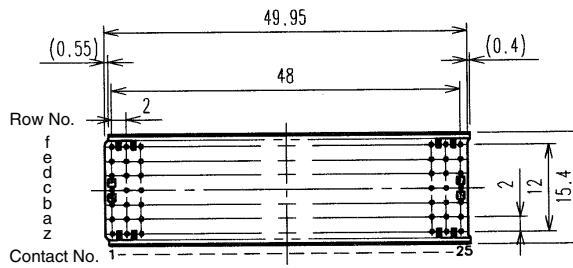

Style	Part number	Applicable connector
A	PCN21-110PA-2C1	PCN21*-110PA-2W(-G)
B	PCN21-125PB-2C1	PCN21*-125PB-2W(-G)
C	PCN21- 55PC-2C1	PCN21*- 55PC-2W(-G)
AB	PCN21-125PAB-2C	PCN21*-125PAB-2W(-G)

■ Mid-plane (Shroud) [Style C]

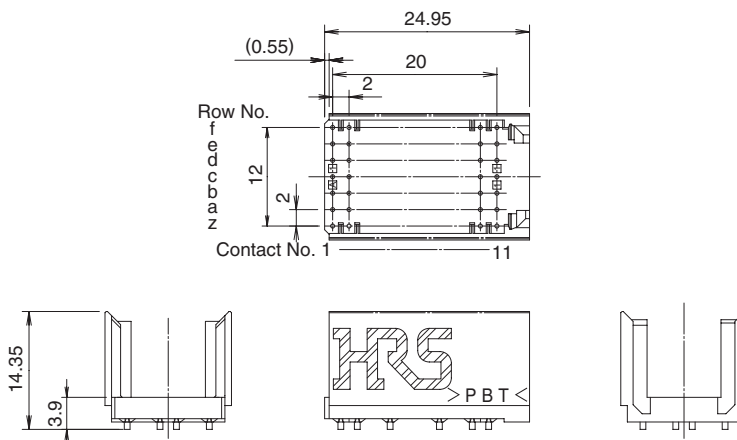

[Type AB]

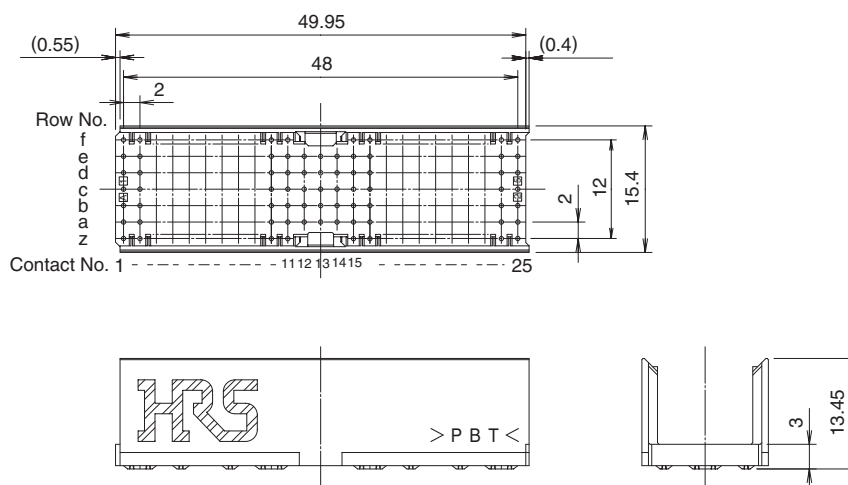

◆ Assembled condition

Back-plane contact length: 13mm (Example)

A	Back-plane contact length	13	13
B	Shroud height	3.9	3
C	PCB thickness	2.3	3.2
D	Shroud mating contact length	6.8	6.8

Shroud mating contact length: 6.8mm (Example)

E	Shroud mating contact length	6.8	6.8
F	Shroud height	3.9	3
G	Back-plane contact length	13	13
H	PCB thickness	2.3	3.2

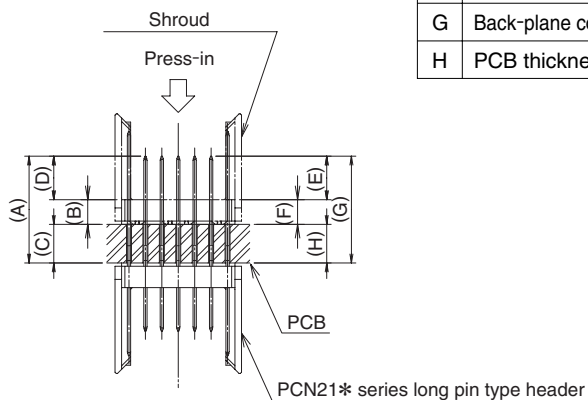

■ Coding keys

Installed on Style A, D, M to prevent improper insertion.

For header

For receptacle

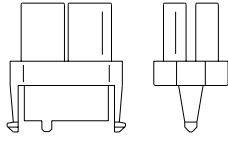
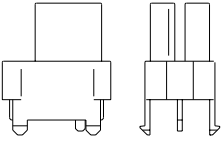
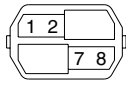
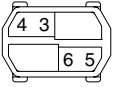

For header		For receptacle		Color	Remarks
Part number	Type	Part number	Type		
PCN21-P-CK(A)	3456	PCN21-S-CK(A)	1278	Yellow	Supports compact PCI 3.3V
PCN21-P-CK(B)	1567	PCN21-S-CK(B)	2348	Blue	Supports compact PCI 5V
PCN21-P-CK(D)	1248	PCN21-S-CK(D)	3567	Red	
PCN21-P-CK(F)	2578	PCN21-S-CK(F)	1346	Breen	
PCN21-P-CK(G)	3467	PCN21-S-CK(G)	1258	Gray	
PCN21-P-CK(I)	3568	PCN21-S-CK(I)	1247	Orange	

◆ Header contact

Custom support for header sequential contacts is available. Contact a Hirose sales representative. Use of rows of contacts having the same length is recommended.

Contact code

A B C K L M N P Q R S T

PKG side

BWB side

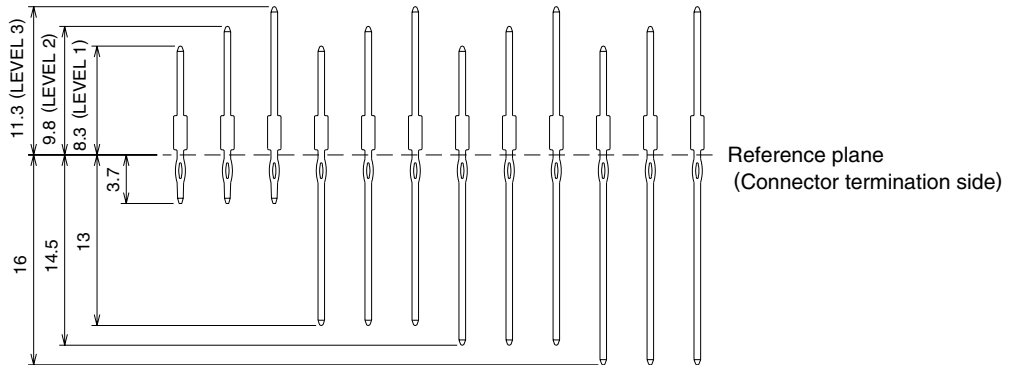

◆ Mating conditions

● Lateral and longitudinal mating tolerance

● Angular tolerance

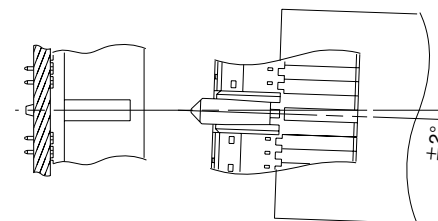
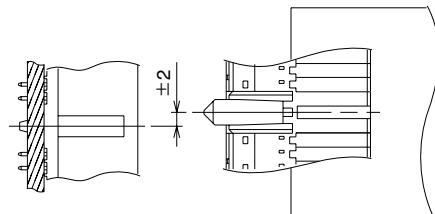
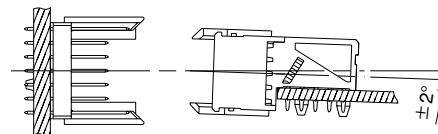
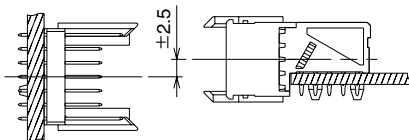

High power contact

PCN21-P-PWR(20A)

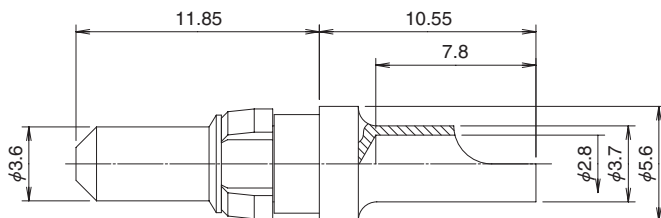

PCN21-S-PWR(PC)

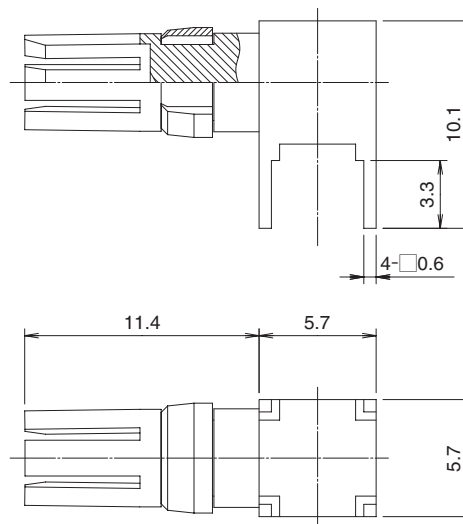

Part number	Power	Applicable connector
PCN21-P-PWR(20A)	20A(70°C)	PCN21*-55PM-2PF
PCN21-S-PWR(PC)	20A(70°C)	PCN21*-55SM-2PF

Coaxial connector

Part number	Characteristic impedance	Applicable cable	Applicable connector
PO51M-J-1.5W	50Ω	1.5D-HQEW, 1.5D-2W or equivalent	PCN21*-55PM-2PF
PO51M-J-1.5	50Ω	1.5D-HQEV, 1.5D-2V or equivalent	PCN21*-55PM-2PF
PO82M-J-1.5C	75Ω	1.5C-QEV, 1.5C-2V or equivalent	PCN21*-55PM-2PF
PO51M-LJ-1.5W	50Ω	1.5D-HQEW, 1.5D-2W or equivalent	PCN21*-55PM-2PF
PO51M-LJ-1.5	50Ω	1.5D-HQEV, 1.5D-2V or equivalent	PCN21*-55PM-2PF
PO51M-LJ-178-1	50Ω	RG-178B/U	PCN21*-55PM-2PF
PO51M-P-1.5W	50Ω	1.5D-HQEW, 1.5D-2W or equivalent	PCN21*-55SM-2PF
PO51M-P-1.5	50Ω	1.5D-HQEV, 1.5D-2V or equivalent	PCN21*-55SM-2PF
PO82M-P-1.5C	75Ω	1.5C-QEV, 1.5C-2V or equivalent	PCN21*-55SM-2PF
PO51M-LPR-PC-1A	50Ω	—	PCN21*-55SM-2PF

Refer to PO21M, PO51M, PO82M series for dimensions.

High power contact, coaxial connector extraction tools

	Part number
For PCN21*-55PM-2PF	PO51J-T-1
For PCN21*-55SM-2PF	PO51MP-T-1