

MODEL L SERIES

Thick Film

Low Profile SIP

Conformal Coated

Resistor Networks

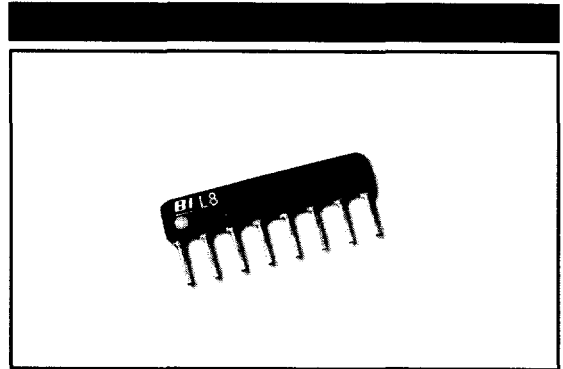

ELECTRICAL

Standard Resistance Range, Ohms	22 to 1Meg
Standard Resistance Tolerance, at 25°C	±2% Optional: ±1% (F Tol.), ±5% (J Tol.)
Operating Temperature Range	-55°C to +125°C
Temperature Coefficient of Resistance	±100ppm/°C (<100 Ohms = ±250ppm/°C)
Temperature Coefficient of Resistance, Tracking	±50ppm/°C
Maximum Operating Voltage	100Vdc or √PR
Insulation Resistance	≥10,000 Megohms

ENVIRONMENTAL

Thermal Shock plus Power Conditioning	ΔR 0.70%
Short Time Overload	ΔR 0.25%
Terminal Strength	ΔR 0.25%
Moisture Resistance	ΔR 0.50%
Mechanical Shock	ΔR 0.25%
Vibration	ΔR 0.25%
Low Temperature Storage	ΔR 0.25%
High Temperature Exposure	ΔR 0.50%
Load Life, 1,000 Hours	ΔR 1.00%
Resistance to Solder Heat (Per MIL-STD-202, Method 210, Cond.B)	ΔR 0.25%
Dielectric Withstanding Voltage	200V for 1 minute
Marking Permanency	MIL-STD 202, Method 215
Lead Solderability	MIL-STD 202, Method 208
Flammability	UL-94V-0 Rated
Storage Temperature Range	-55°C to +150°C

Specifications subject to change without notice.

MECHANICAL

Lead Material	Steel Alloy (Standard) Copper Alloy (Optional)
Lead Finish	90/10 Tin-Lead
Substrate Material	Alumina
Resistor Material	Cermet
Body Material	Conformal Epoxy Resin

STANDARD RESISTANCE VALUES, OHMS

-3 Circuit (Isolated Resistors) & -1 Circuits (Bussed Resistors)

Ohms	Code	Ohms	Code	Ohms	Code
22	220	820	821	33K	333
27	270	1K	102	39K	393
33	330	1.2K	122	47K	473
39	390	1.5K	152	51K	513
47	470	1.8K	182	56K	563
51	510	2K	202	68K	683
56	560	2.2K	222	82K	823
68	680	2.7K	272	100K	104
82	820	3.3K	332	120K	124
100	101	3.9K	392	150K	154
120	121	4.7K	472	180K	184
150	151	5.1K	512	200K	204
180	181	5.6K	562	220K	224
200	201	6.8K	682	270K	274
220	221	8.2K	822	330K	334
270	271	10K	103	390K	394
330	331	12K	123	470K	474
390	391	15K	153	510K	514
470	471	18K	183	560K	564
510	511	20K	203	680K	684
560	561	22K	223	820K	824
680	681	27K	273	1Meg	105

-5 Circuit (Dual Terminators)

Ohms	Code	Ohms	Code	Ohms	Code
R1/R2	R1/R2	R1/R2	R1/R2	R1/R2	R1/R2
180/390	181/391	330/390	331/391	3K/6.2K	302/622
220/270	221/271	330/470	331/471		
220/330	221/331	330/680	331/681		

POWER DERATING CURVE

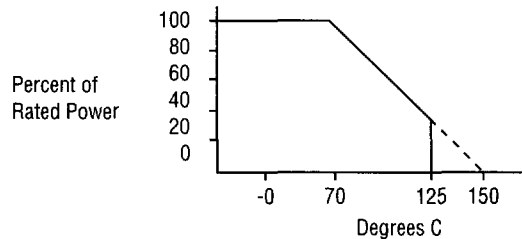

POWER DISSIPATION, WATTS AT 70 °C

Model	Package	— Resistor (Per Circuit) —		
		-1	-3	-5
L06	.6	.125	.200	.125
L08	.8	.125	.200	.125
L10	1.0	.125	.200	.125

OUTLINE DIMENSIONS (Inch/mm)

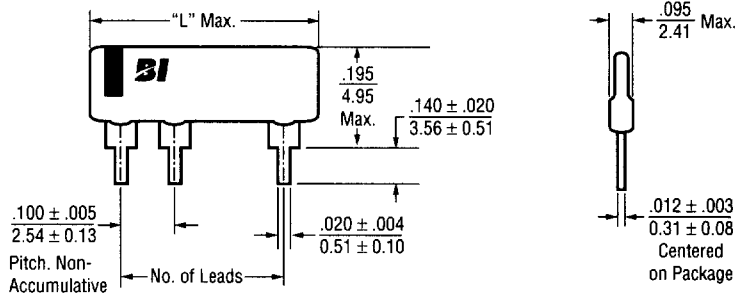

# of Leads	4	5	6	7	8	9	10	11	12	13	14
Dim. "L" Max.	.40 10.16	.50 12.70	.60 15.24	.70 17.78	.80 20.32	.90 22.86	1.00 25.40	1.10 27.94	1.20 30.48	1.30 33.02	1.40 35.56

4

SCHEMATICS

**-3 Circuit
Isolated Resistors**

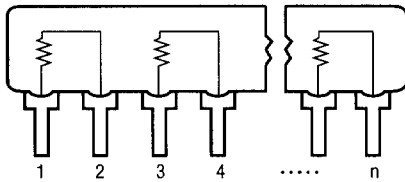

**-1 Circuit
Bussed Resistors**

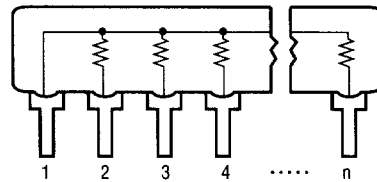

**-5 Circuit
Dual Terminator**

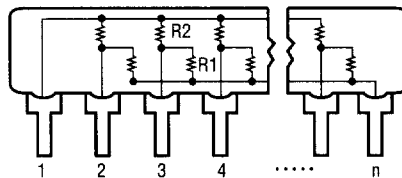

TYPICAL PART MARKING

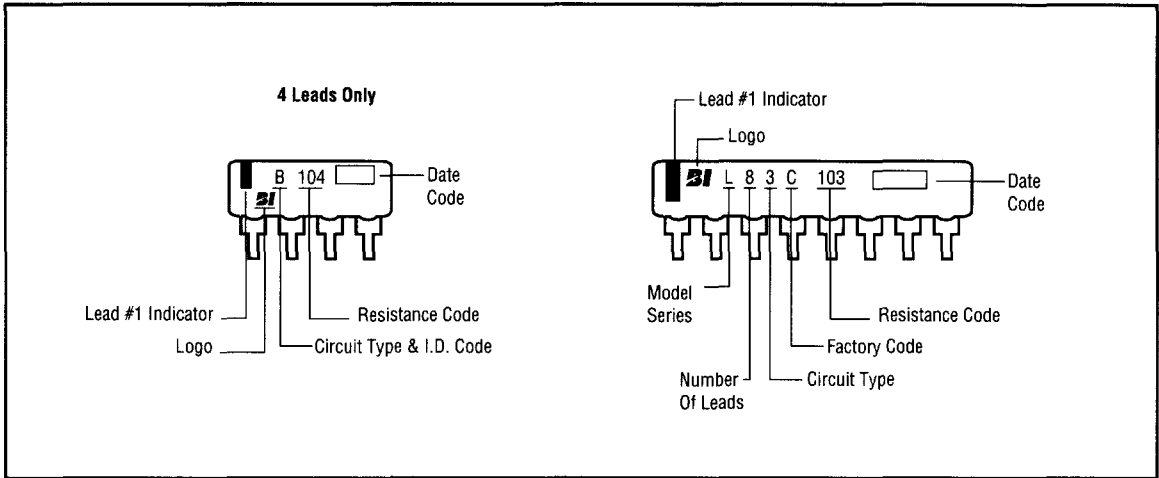

PACKAGING

Standard: Bulk: Quantity = 500 (Europe)
200 Units (USA/Asia)

Option: Tape in Ammo Box (Steel pins only).
All Units oriented with lead #1 to the left of direction of feed.

Tape: Width = 18mm

Pitch = 12.7mm

Ammo Box: Capacity = 1,000 Units

Option: Magazine
Dimensions conform to EIA & JEDEC standards.
All Units oriented with lead #1 to the same side.

Magazine: Material = Antistatic Plastic

ORDERING INFORMATION

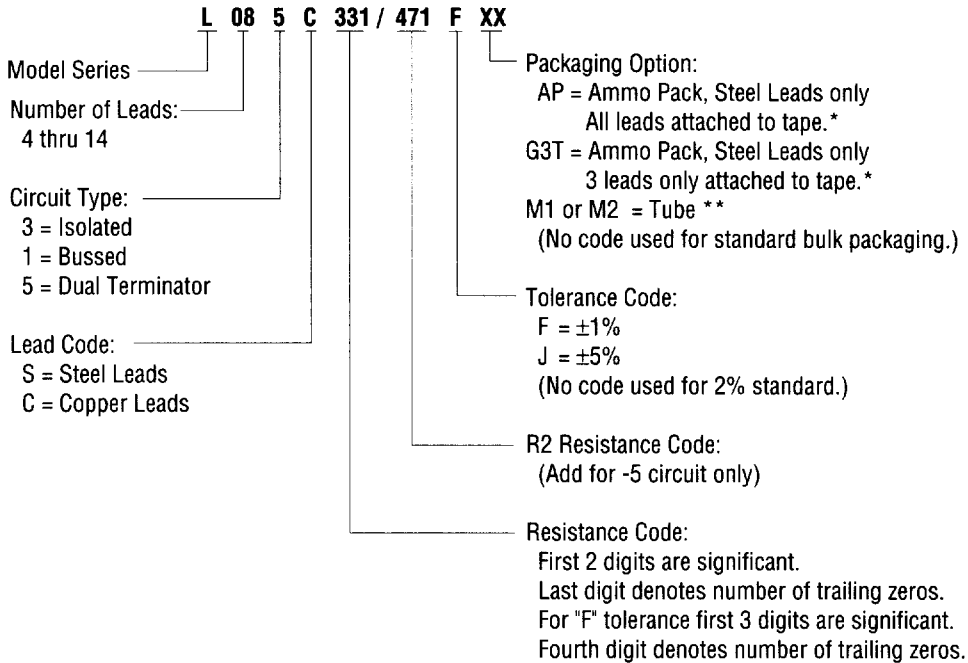

- * Refer to Packaging for Automation section (Page A-3) for Ammo Pack capacity and dimensions.
** Refer to Packaging for Automation section (Page A-4) for M1 and M2 tube capacity and dimensions.

APPLICABLE DOCUMENTS

MIL-R-83401 — Resistor Networks, Fixed, Film, General Specifications
MIL-STD-105 — Sampling Procedures and Tables for Inspection by Attributes
MIL-STD-202 — Test Methods for Electronic and Electrical Component Parts