

# PO51 PO72 SERIES RF CO-AXIAL CONNECTORS

## PCN10F series co-axial connectors

### Scope

The PO51, PO72 series has been developed for the PCB multipole connector PCN10F series (DIN41612, M style).

It is the plug in type of co-axial connectors in correspondence to the DIN47297 nominal impedance 50  $\Omega$  (PO51), 75  $\Omega$  (PO72).

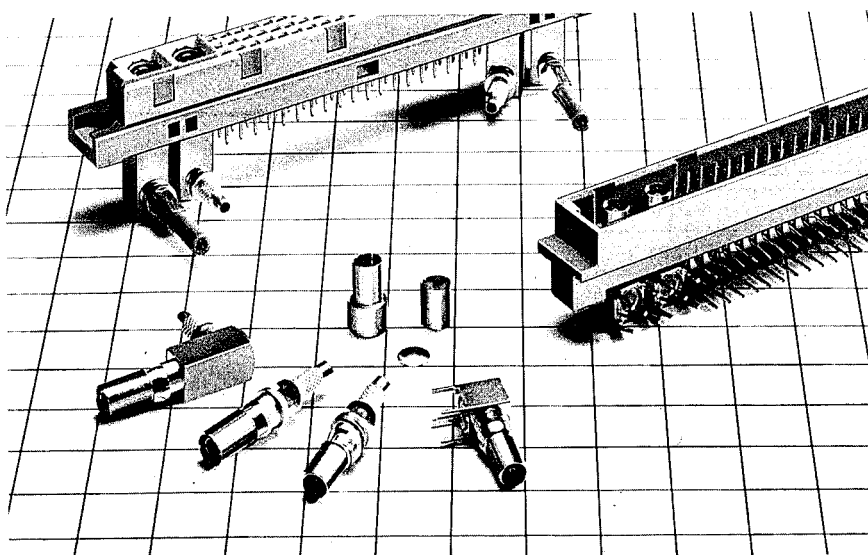

### Features

- (1) In combination with PCN10F series composite connector, offers high density in applying to various electronic equipment.
- (2) The plug in type assures easy and quick connecting and disconnecting.

### Applications

Communication equipment, transmission equipment, measuring instruments, etc.

### Specifications

Item	Specification	
	PO51	PO72
Part No.	PO51	PO72
Impedance characteristics	50 $\Omega$	75 $\Omega$
Insulation resistance	DC 500 V/1000 M $\Omega$ min.	
Contact resistance	Center 6 (7) m $\Omega$ max. Outer 3 (4) m $\Omega$ max. at DC 1 A	
Withstand voltage	AC 750 V for a minute	
V. S. W. R.	10 MHz – 1 GHz under 1.2	

Note: Value of ( ) shown PO51-LP-Pc-A and PO72-LR-PC-A.

# PO51 PO72 SERIES RF CO-AXIAL CONNECTORS

## Information

For PCN10F-  S-2.54

### ▲ Plug

HRS No.	Part No.	Applicable cable
CL330-0004-8	PO51-P-1.5-1A	1.5D-2V
CL330-0152-5	PO72-P-1.5C-1A	1.5C-2V

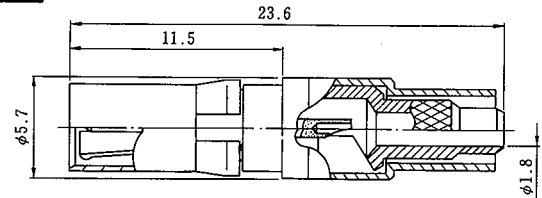
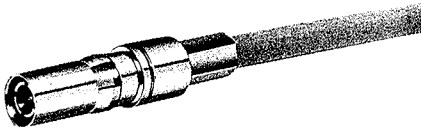

### ▲ L-type plug

HRS No.	Part No.	Applicable cable
CL330-0007-6	PO51-LP1.5-A	1.5D-2V
CL330-0162-9	PO72-LP-1.5C-A	1.5C-2V

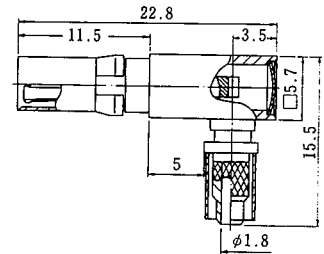
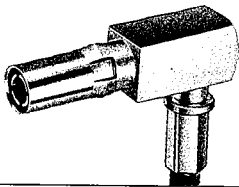

HRS No.	Part No.	Applicable cable
CL330-0160-3	PO72-LP-1.5C-1A	1.5C-2V

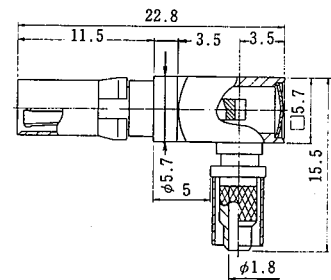
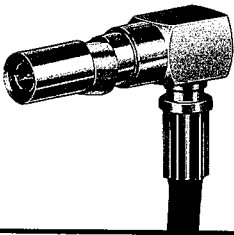

For PCN10FA-  S-2.54

### ▲ Plug receptacle (for PCB mounting type)

HRS No.	Part No.	Impedance characteristic
CL330-0032-3	PO51-PR-PC-A	50 Ω

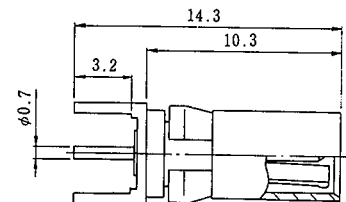
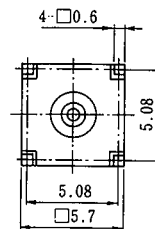
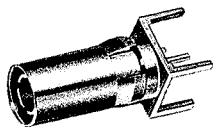

# PO51 PO72 SERIES RF CO-AXIAL CONNECTORS

For PCN10F-- P-254D

▲ L-type receptacle (PCB mounting type)

HRS No.	Part No.	Impedance characteristic
CL330-0017-0	PO51-LR-PC-1	50 Ω
CL330-0166-0	PO72-LR-PC-1	75 Ω

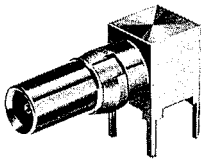

\* Receptacle for PCN10F-- P-254DS

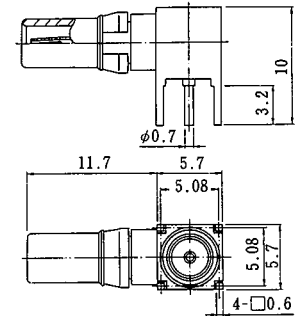

HRS No.	Part No.	Impedance characteristic
CL330-0018-2	PO51-LR-PC-A	50 Ω
CL330-0168-5	PO72-LR-PC-A	75 Ω

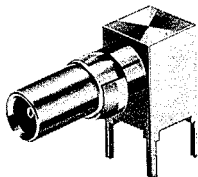

\* Receptacle for PCN10FA-- P-254DS

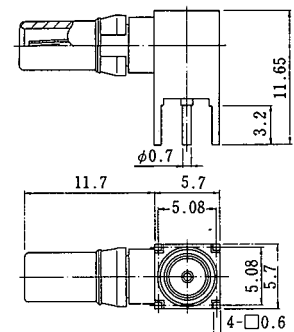

For PCN10F- P-2.54DS

▲ Jack

HRS No.	Part No.	Applicable cable
CL330-0021-7	PO51-J-1.5	1.5D-2V
CL330-0171-0	PO72-J-1.5C	1.5C-2V

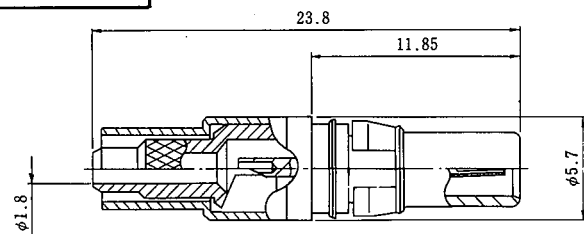
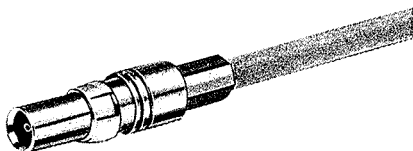

# PO51 PO72 SERIES RF CO-AXIAL CONNECTORS

## Extraction tools

### For PO51·PO72 plug

PO51P-T-1  
CL350-0037-1

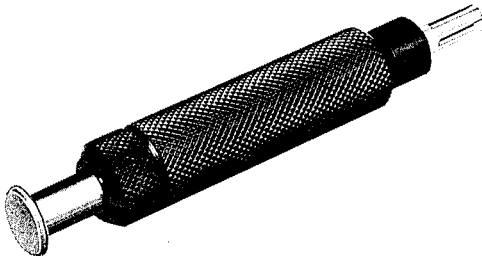

PO51P-T-1S  
CL350-0039-7  
Sleeve for exchange

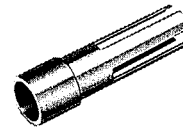

### For PO51·PO72 jack

PO51J-T-1  
CL350-0038-4

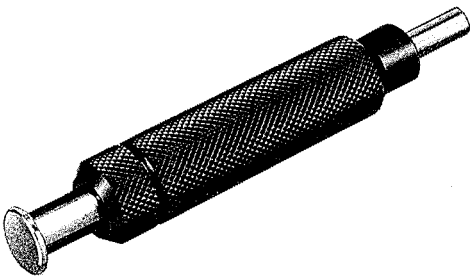

PO51J-T-1S  
CL350-0040-6  
Sleeve for exchange

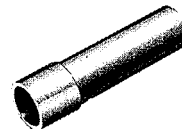

# PO51 PO72 SERIES RF CO-AXIAL CONNECTORS

## Backboard dimensions

PO51-LR-PC-1, PO51-LR-PC-A, PO51-PR-PC-A, PO72-LR-PC-1, PO72-LR-PC-A

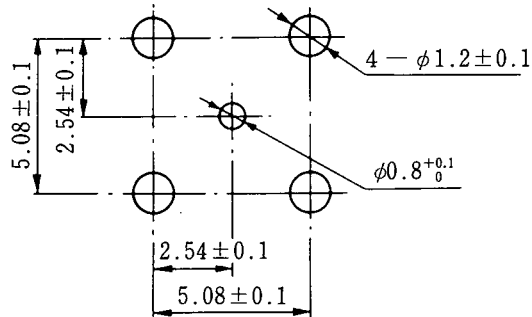

PO51-P-1.5-1A  
PO72-P-1.5C-1A  
PO72-LP-1.5C-1A

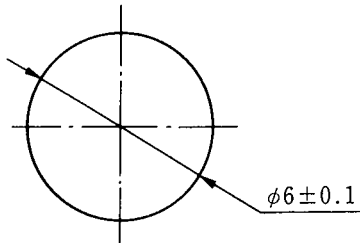

PO51-LP-1.5-A  
PO72-LP-1.5C-A

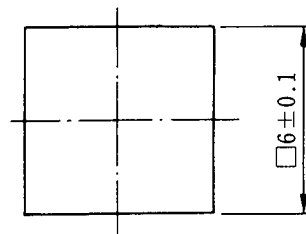

# PO51 PO72 SERIES RF CO-AXIAL CONNECTORS

## Terminating method

### 1. PO51-LP-1.5-A, PO72-LP-1.5C-A, PO72-LP-1.5C-1A

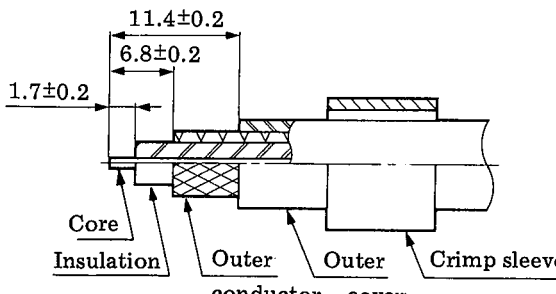
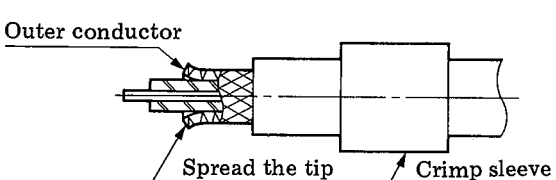
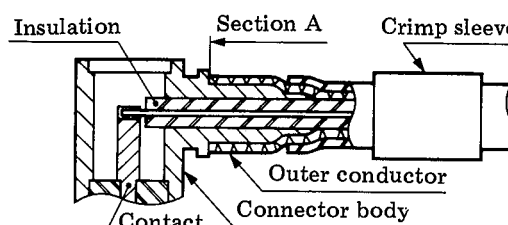
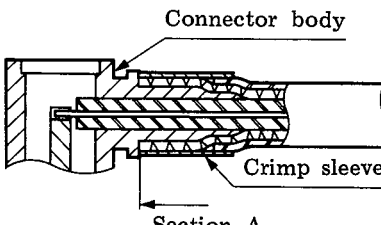
No.	Work drawing	Description
1		<p>(1) Terminate the cable to the dimensions shown in the figure using care not to cut the components such as core, insulation, and outer conductor.</p> <p>(2) Fit the crimp sleeve to the cable as shown in the figure. Check for the direction of the sleeve.</p>
2		<p>(1) Spread the tip of the outer conductor as shown in the figure.</p>
3		<p>(1) Push the cable end into the connector body until the tip of the outer conductor touches section A or the insulation contacts the contact.</p>
4		<p>(1) Insert the crimp sleeve until it contacts section A as shown in the figure.</p>

**PO51  
PO72 SERIES**

**RF CO-AXIAL CONNECTORS**

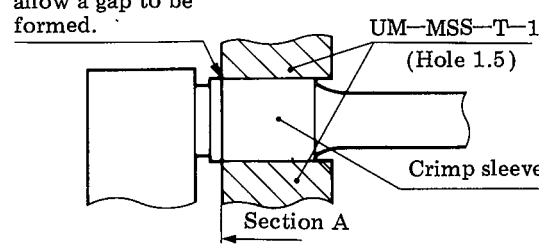
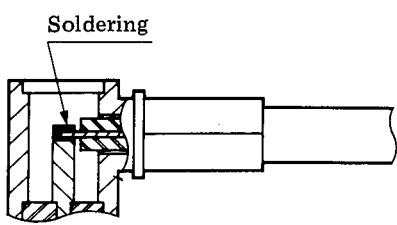
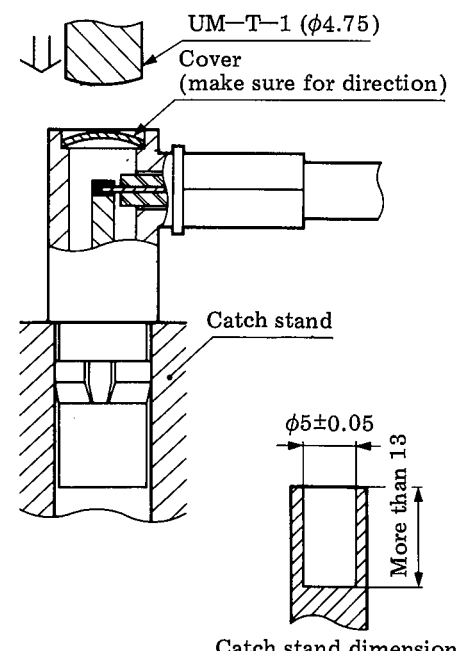
No.	Work drawing	Description
5	<p>Be careful not to allow a gap to be formed.</p> 	<p>(1) As shown in the figure, caulk the crimp sleeve to the cable end with a 1.5 hexagonal hole (smallest hole) in the crimping tool UM-MSS-T-1. During caulking, use care not to allow a gap to be formed between the crimping tool and section A.</p>
6		<p>(2) Solder the core. Avoid butt soldering. Also, prevent solder from adhering to the outer surface of the male contact. After soldering, clean the inside of the connectors using thinner and air to prevent faulty insulation and withstand voltage.</p>
7		<p>(1) Fit the cover in the direction as shown in the Figure, and press it until it becomes flat with the UM-T-1 (φ4.75) using a drill press.</p>

# PO51 PO72 SERIES RF CO-AXIAL CONNECTORS

## Terminating method

### 1. PO51-P-1.5-1A, PO51-J-1.5, PO72-P-1.5C-1A, PO72-J-1.5C

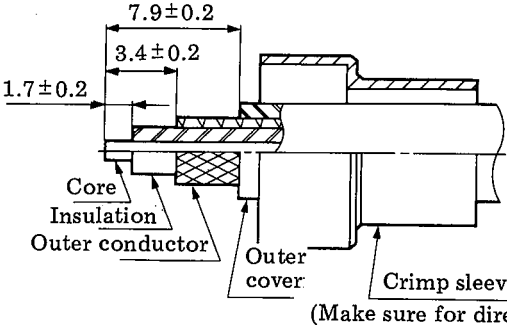
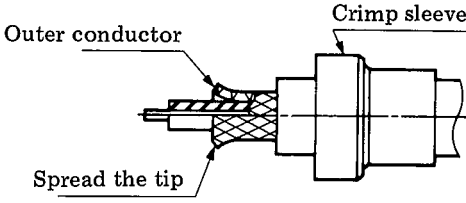
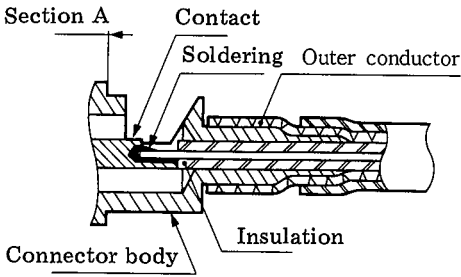
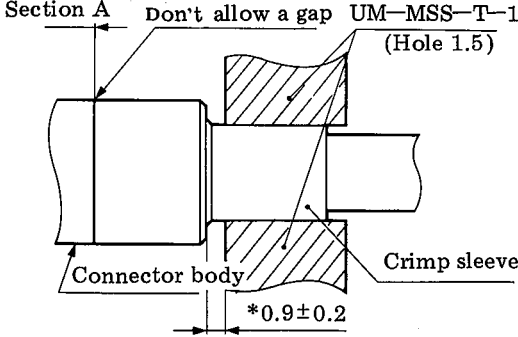
No.	Work drawing	Description
1		<ol style="list-style-type: none"> <li>(1) Terminate the cable to the dimensions shown in the figure using care not to cut the components such as core, insulation, and outer conductor.</li> <li>(2) Fit the crimp sleeve to the cable as shown in the figure. Check for the direction of the sleeve.</li> </ol>
2		<ol style="list-style-type: none"> <li>(1) Spread the tip of the outer conductor as shown in the figure.</li> </ol>
3		<ol style="list-style-type: none"> <li>(1) Push the cable end into the connector body until the tip of the insulation touches the contact as shown in the figure.</li> <li>(2) Solder the core. Avoid butt soldering. After soldering, clean the inside of the connector using thinner and air to prevent faulty insulation and withstand voltage.</li> </ol>
4		<ol style="list-style-type: none"> <li>(1) As shown in the figure, caulk the crimp sleeve at the small end with the 1.5 hexagonal hole (smallest hole) in the crimping tool UM-MSS-T-1. No gap is allowed at section A where the connector body fits into the crimp sleeve.                      Note: Strictly follow the dimension marked with * (<math>0.9 \pm 0.2</math>).</li> </ol>