

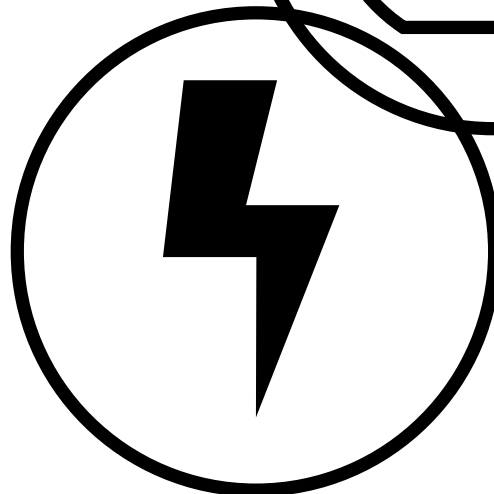

**WORLD PRODUCTS INC.**  
ELECTRONIC COMPONENT SOLUTIONS

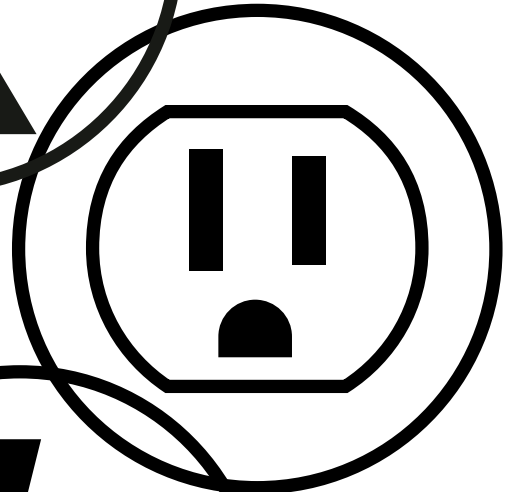

# FERRITE BEAD ARRAYS

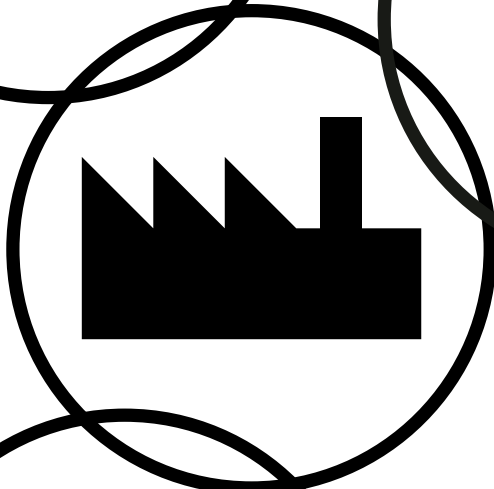
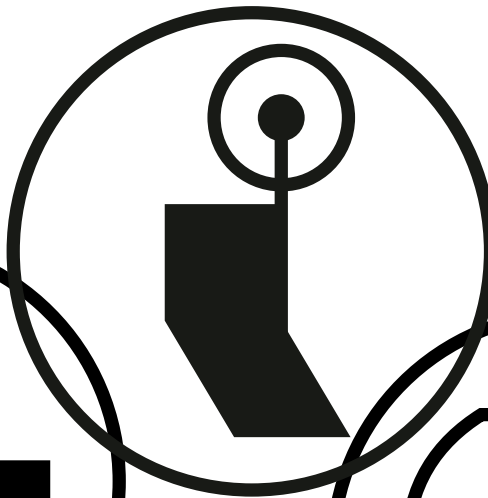
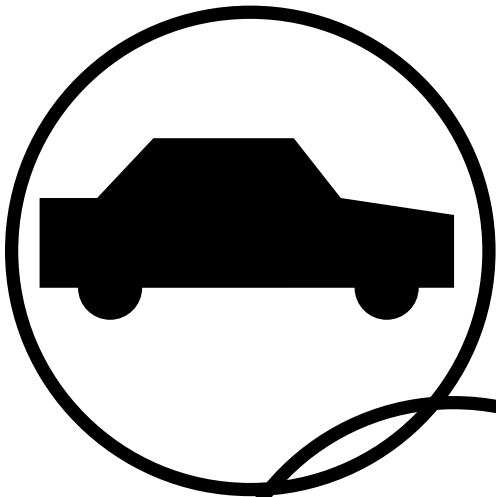

# CHIP FERRITE BEAD ARRAYS

## Features

1. Available in a wide range of impedance values.
2. Providing excellent EMI suppression characteristics for various types of noise.
3. 4 lines achieved with a single chip, very useful in high density circuit design.
4. Heat generation and crosstalk between adjacent circuits are at minimum.
5. Excellent solderability.
6. RoHS compliant with Directive 2002/95/EC of the European Parliament and of the Council of 27 January 2003 on the restriction of the use of certain hazardous substances in electrical and electronic equipment (RoHS Directive) and comply to a maximum concentration value of 0.1% by weight in homogeneous materials for lead (Pb), mercury, hexavalent chromium, polybrominated biphenyls (PBB) and polybrominated diphenyl ethers (PBDE) and of 0.01% weight in homogeneous materials for cadmium.

## Applications

1. Waveform correction in personal computers, electric equipment, communication equipment, OA equipment.
2. Provides radiated noise countermeasures in interfaces and harness connecting parts.
3. Prevents noise intrusion in video, LCD module, etc.
4. Parallel signal line.

## Ordering Information

**WPB** - **4** **M** - **3216** **□** - **121** **T**  
 (1) (2) (3) (4) (5) (6) (7)

**(1) Series**

**WPB:** For signal line

**(2) Type**

**4:** Array

**(3) Material and Design**

**H:** For general purpose

**S:** For high speed

**M:** For high impedance type

**T, V:** For Low speed

**(4) Dimensions\***

First two digits: length(mm)

Last two digits: width(mm)

**(5) Thickness**

**A:** 0.9mm max

**B:** 0.7mm max

**C:** 1.2mm max

**(6) Impedance (at 100MHz)**

First two digits are impedance values.

Last digit is the number of zeros following.

**(7) Packaging**

**B:** Bulk Package

**T:** Tape & Reel (Φ 178mm [ 7 inch ])

**L:** Tape & Reel (Φ 254mm [10 inch ])

\*2012(mm) is equivalent to 0805 (inches).

3216(mm) is equivalent to 1206 (inches).

## Shape & Dimensions

Type		L	W	T	C <sub>1</sub>	C <sub>2</sub>	D	M
WPB-4□2010	B	2.00±0.15 [.079±.006]	1.00±0.15 [.063±.008]	0.60±0.1 [.031±.004]	0.25±0.15 [.020±.006]	0.3 max [.012 max]	0.50±0.10 [.020±.004]	0.2 max [.008 max]
	A	3.20±0.2 [.126±.008]	1.60±0.2 [.063±.008]	0.80±0.1 [.031±.004]	0.40±0.15 [.016±.006]	0.30±0.10 [.012±.004]	0.80±0.1 [.031±.004]	0.20±0.1 [.008±.004]
WPB-4□3216	B	3.20±0.2 [.126±.008]	1.60±0.2 [.063±.008]	0.60±0.1 [.024±.004]	0.40±0.15 [.016±.006]	0.30±0.10 [.012±.004]	0.80±0.1 [.031±.004]	0.20±0.1 [.008±.004]
	C	3.2±0.2 [.126±.008]	1.60±0.2 [.063±.008]	1.10±0.1 [.043±.004]	0.40±0.15 [.016±.006]	0.30±0.10 [.012±.004]	0.80±0.1 [.031±.004]	0.20±0.1 [.008±.004]

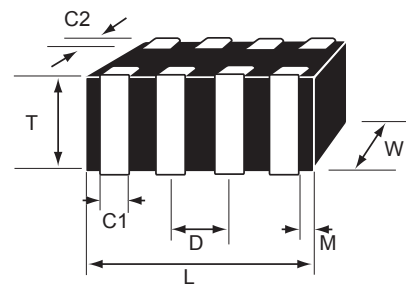

# CHIP FERRITE BEAD ARRAYS

## Specifications

Part No.	IZI at 100 MHz( $\Omega$ )		DCR ( $\Omega$ ) max	Rated current (mA) max
	typ	min		
WPB-4M2010□-100□	10	7.5	0.10	200
WPB-4M2010□-400□	40	30	0.15	200
WPB-4M2010□-600□	60	45	0.30	200
WPB-4M2010□-800□	80	60	0.30	200
WPB-4M2010□-121□	120	90	0.40	150
WPB-4M2010□-201□	200	150	0.60	100
WPB-4M2010□-301□	300	225	0.80	50
WPB-4T2010□-100□	10	7.5	0.10	200
WPB-4T2010□-400□	40	30	0.15	200
WPB-4T2010□-600□	60	45	0.30	200
WPB-4T2010□-800□	80	60	0.30	200
WPB-4T2010□-121□	120	90	0.40	150
WPB-4T2010□-201□	200	150	0.60	100
WPB-4T2010□-301□	300	225	0.80	50
WPB-4S2010□-100□	10	7.5	0.20	200
WPB-4S2010□-300□	30	23	0.30	200
WPB-4S2010□-600□	60	45	0.40	150
WPB-4S2010□-101□	100	75	0.50	150
WPB-4H3216□-300□	30	22	0.10	200
WPB-4M3216□-600□	60	45	0.12	200
WPB-4M3216□-800□	80	60	0.15	150
WPB-4M3216□-121□	120	90	0.20	100
WPB-4M3216□-201□	200	150	0.30	100
WPB-4M3216□-241□	240	180	0.40	100
WPB-4M3216□-301□	300	225	0.45	100
WPB-4M3216□-471□	470	353	0.45	100
WPB-4M3216□-601□	600	450	0.50	100
WPB-4M3216□-102□	1000	750	0.80	100
WPB-4T3216□-600□	600	450	0.12	200
WPB-4T3216□-121□	120	90	0.20	200
WPB-4T3216□-201□	200	150	0.30	150
WPB-4T3216□-241□	240	180	0.40	150
WPB-4T3216□-301□	300	225	0.45	150
WPB-4T3216□-601□	600	450	0.50	100
WPB-4T3216□-102□	1000	750	0.80	50
WPB-4S3216□-500□	50	37	0.20	200
WPB-4S3216□-800□	80	60	0.25	200
WPB-4S3216□-121□	120	90	0.25	200
WPB-4S3216□-201□	200	150	0.30	200
WPB-4S3216□-241□	240	180	0.35	200
WPB-4S3216□-301□	300	225	0.40	200
WPB-4V3216□-400□	40	30	0.15	200
WPB-4V3216□-600□	60	45	0.20	200
WPB-4V3216□-800□	80	60	0.20	200
WPB-4V3216□-121□	120	90	0.30	150
WPB-4V3216□-201□	200	150	0.40	100
WPB-4V3216□-301□	300	225	0.50	100

\* Parts with other electrical characteristics can be provided upon request. \* Test equipment : HP4291A + HP161692A

# CHIP FERRITE BEAD ARRAYS

## Electrical Characteristics

### 4 Array 3216 Series

WPB-4H3216A-300

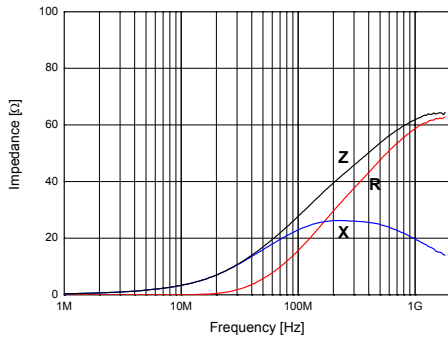

WPB-4M3216A-600

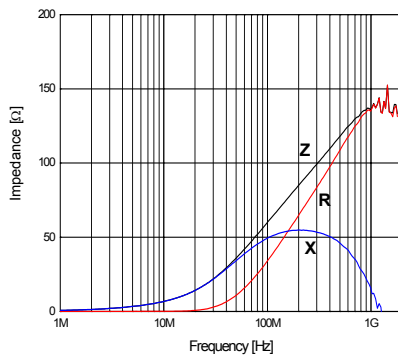

WPB-4M3216A-800

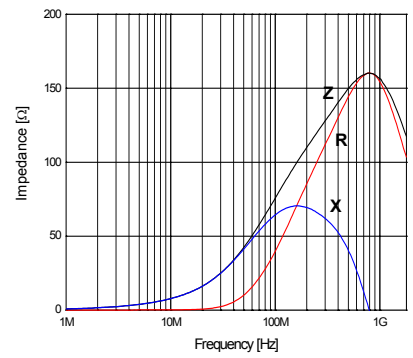

WPB-4M3216A-121

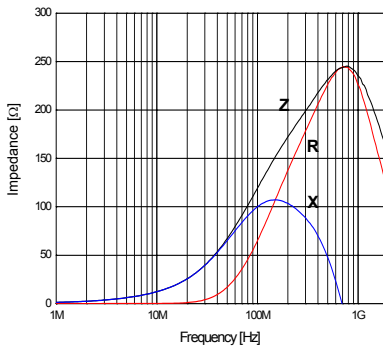

WPB-4M3216A-201

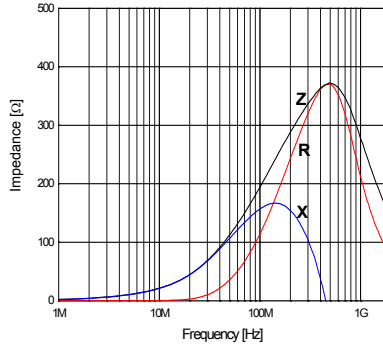

WPB-4M3216A-241

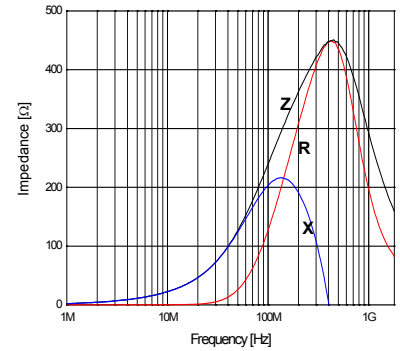

WPB-4M3216A-301

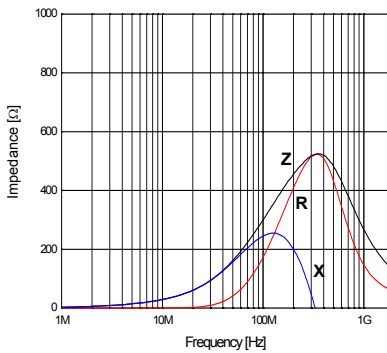

WPB-4M3216A-471

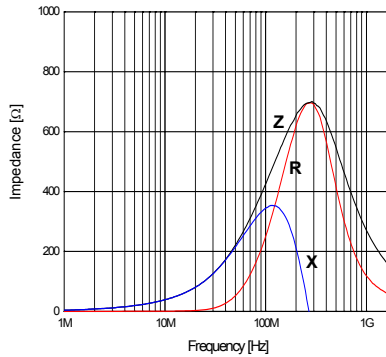

WPB-4M3216A-601

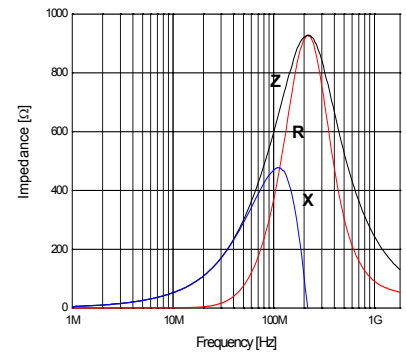

# CHIP FERRITE BEAD ARRAYS

**WPB-4M3216A-102**

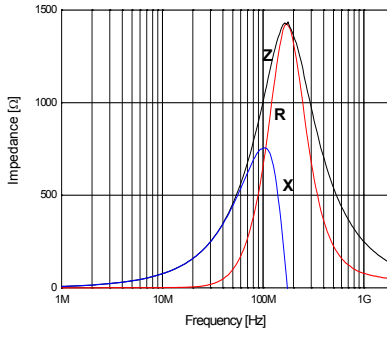

**WPB-4T3216A-121**

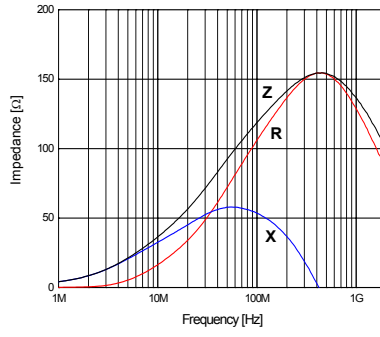

**WPB-4T3216A-201**

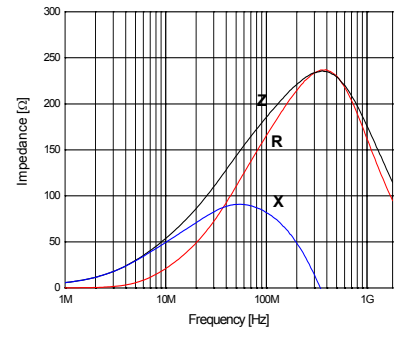

**WPB-4T3216A-301**

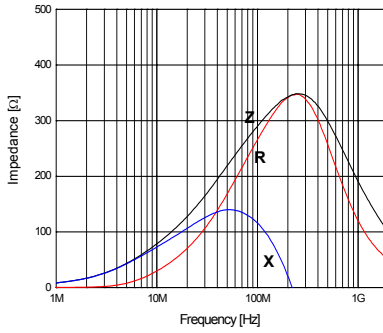

**WPB-4T3216A-601**

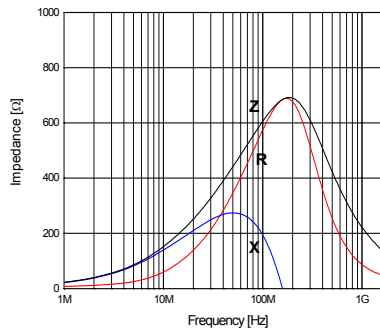

**WPB-4T3216A-102**

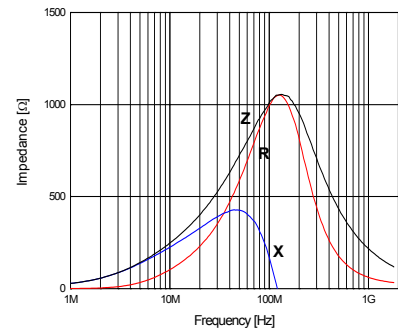

**WPB-4S3216A-800**

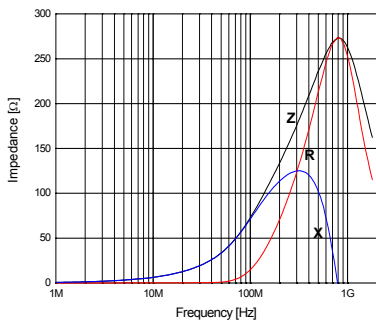

**WPB-4S3216A-121**

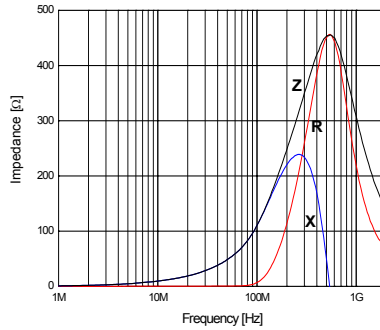

**WPB-4S3216A-201**

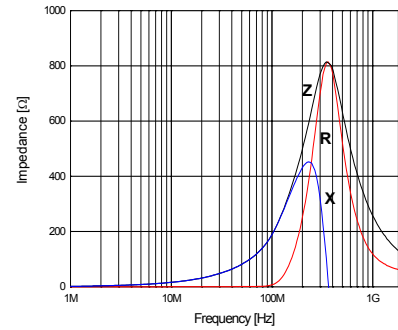

**WPB-4S3216A-301**

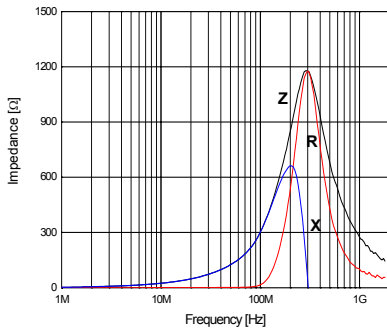

# CHIP FERRITE BEAD ARRAYS

## 4 Array 2012 Series

**WPB-4M2010B-400**

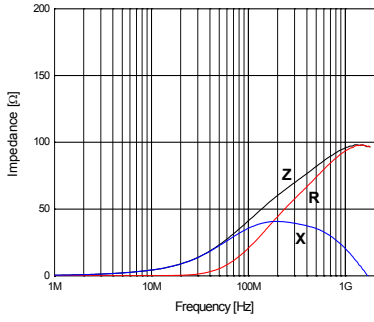

**WPB-4M2010B-600**

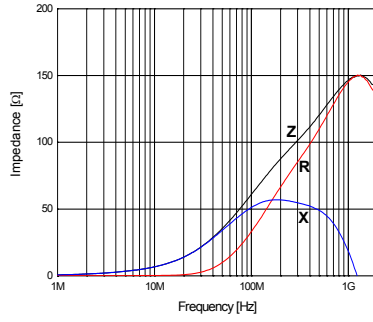

**WPB-4M2010B-121**

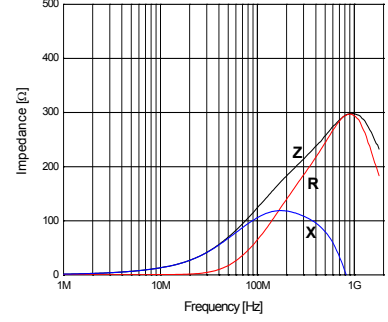

**WPB-4M2010B-201**

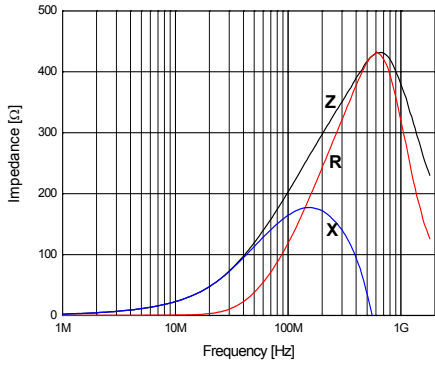

**WPB-4M2010B-301**

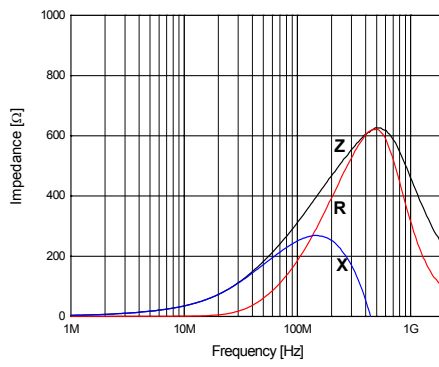

# CHIP FERRITE BEAD ARRAYS

## Reliability and Test Conditions

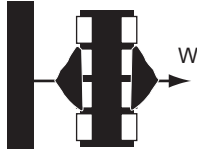
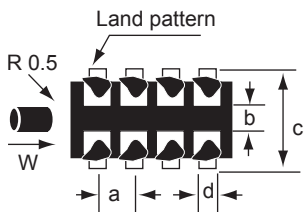
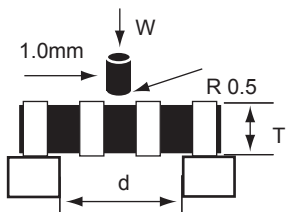
ITEM	REQUIREMENTS			TEST CONDITION	
	3216	2012			
Operating temp.range	-55°C~+125°C			-	
Storage temp. & humidity range	40°C max. , 70% RH max.			at packing condition	
Resistance to solder heat	1. No damage such as cracks should be caused in chip element. 2. More than 75% of the terminal electrode shall be covered with new solder. 3. Impedance change: ±30%			Preheat temperature: 100 to 150°C Preheat time: 1min Solder temperature: 260 ± 10°C Dipping time: 10 ± 0.5sec.	
Solderability	1. More than 90% of the terminal electrode shall be covered with new solder. 2. Inductance change : ± within 5% 3. Impedance change: ±30%			Preheat temperature: 100 to 150°C Preheat time: 1min Solder temperature: 230 ± 10°C Dipping time: 3 ± 1sec.	
Reflow soldering	1. More than 50% of the terminal electrode shall be covered with new solder. 			Preheat temperature: 150°C Preheat time: 1min Solder temperature: 230 ± 10°C Dipping time: 3 ± 1sec.	
Tensile strength (Terminal strength)	1. No mechanical damage.				
	W	1.2(1.0)	0.6		Unit : Kgf(W) "T"max. 0.7mm W (kgf) min.
Adhesion of Terminal electrode (Flexure strength)	1. No mechanical damage				
	Unit : mm (a,b,c), Kgf(W)				
	a	0.8	0.5		-
	b	0.8	0.5		-
	c	3.0	2.0		-
	d	0.4	0.25		-
Body strength (Bending strength)	1. The body shall not be damaged by forces applied (see illustration.)				
	Unit : mm (d), Kgf(W)				
	d	2.0	1.3		-
W	3.0	2.0	-		

# CHIP FERRITE BEAD ARRAYS

## Reliability and Test Conditions

ITEM	REQUIREMENTS		TEST CONDITION
	3216	2012	
Drop	1. No mechanical damage 2. Impedance change: $\pm$ within 30%		Drop 10 times on a concrete Floor from a height of 91cm
Vibration	1. No mechanical damage 2. Impedance change: $\pm$ within 30%		Frequency: 10~55~10Hz Amplitude: 1.52mm Direction and time: X,Y,Z directions for 2 hours
Thermal shock (Temperature cycle)	1. No mechanical damage 2. Impedance change: $\pm$ within 30%		Step1. $-40 \pm 3^{\circ}\text{C}$ 30 $\pm$ 3min. Step2. $85 \pm 3^{\circ}\text{C}$ 30 $\pm$ 3min. Number of cycle: 100 times
Heat load resistance	1. No mechanical damage 2. Impedance change: $\pm$ within 30%		Temperature: $85 \pm 2^{\circ}\text{C}$ Applied current: rated current Time: 1,000 hours Measured at ambient temperature after placing for 24 hours
Low temp. resistance	1. No mechanical damage 2. Impedance change: $\pm$ within 30%		Temperature: $-40 \pm 5^{\circ}\text{C}$ Time: 1,000 hours Measured at ambient temperature after placing for 24 hours
Humidity resistance	1. No mechanical damage 2. Impedance change: $\pm$ within 30%		Temperature: $40 \pm 2^{\circ}\text{C}$ Humidity: 90~95% RH Applied current: rated current Time: 500 hours Measured at ambient temperature after placing for 24 hours
Humidity load resistance	1. No mechanical damage 2. Impedance change: $\pm$ within 30%		Temperature: $40 \pm 2^{\circ}\text{C}$ Humidity: 90~95% RH Applied current: rated current Time: 500 hours Measured at ambient temperature after placing for 24 hours
Cross	1. Cross talk: Max $-30\text{dB}$ 2. Cross talk= $20 \log (V_x/V_{in})$		Drop voltage: 5V Pulse Width: 100ns Pulse duration: 16.6 ms Test diagram: Fig. 1

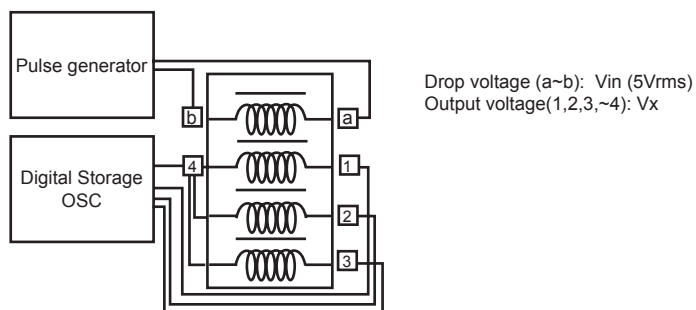
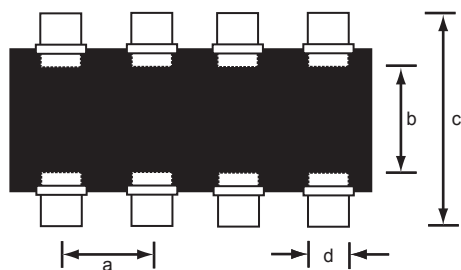

Fig. 1 Cross talk test diagram



# CHIP FERRITE BEAD ARRAYS

## Land Pattern Design



unit: mm

Size	a	b	c	d
3216	0.8	0.8	3.0	0.5
2012	0.5	0.5	1.5	0.4

## Labeling

### Label

- 1) Part name.
- 2) Lot No.
- 3) Quantity.

### Standard quantity for packing

Packing Type(EIA)	Tape & reel			Bulk
	Reel	Inner box	Carton box	Vinyl or Cassette
3216	3,000	30,000	120,000	As requested
	7,000	70,000	280,000	

\*Packing method can be changed upon request.

## Tape Dimensions

### Embossing 8mm

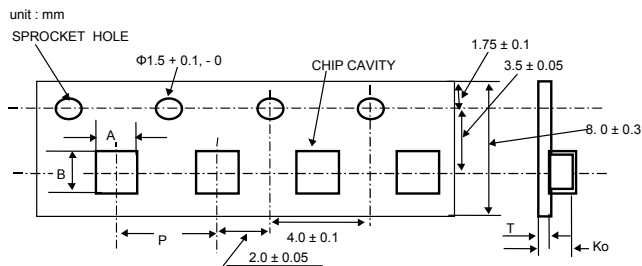

unit: mm

Type	A $\pm 0.1$	B $\pm 0.1$	P $\pm 0.1$	K <sub>0</sub> $\pm 0.1$	T (max.)
3216	1.90	3.60	4.0	1.00	0.3
	1.90	3.60	4.0	1.35	0.3

# CHIP FERRITE BEAD ARRAYS

## Leader and Blank Portion

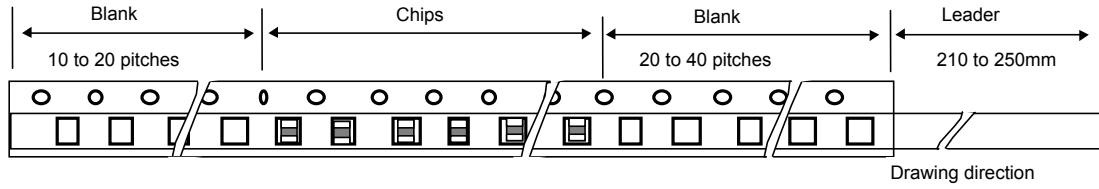

The pitch holes shift within  $\pm 0.3\text{mm}$  for cumulative 10 pitches.

## Reel Dimensions

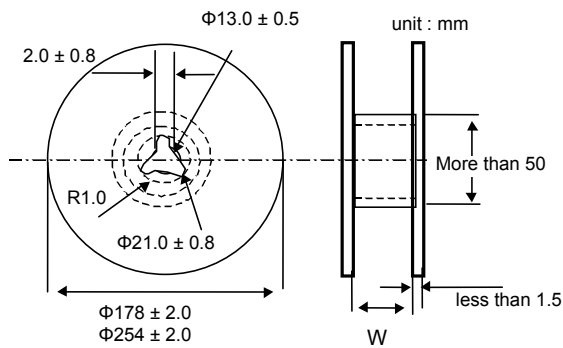

Type	W (mm)
3216 Array	$9.0 \pm 0.3$

## Top Cover Tape Strength

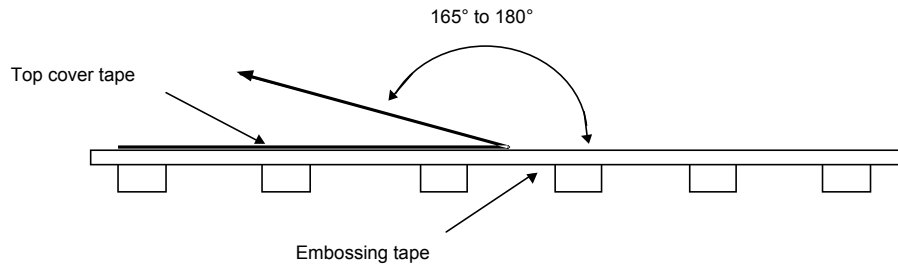

The force for tearing off top cover tape is 20 to 70 grams in the arrow direction.

# CHIP FERRITE BEAD ARRAYS

## Soldering Profile

**REFLOW SOLDERING(Peak 230°C)**

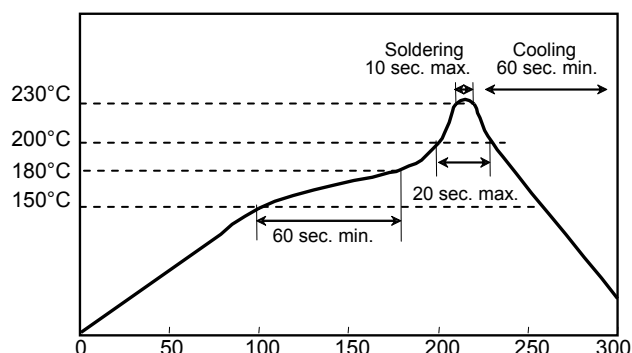

**REFLOW SOLDERING (Peak 250°C)**

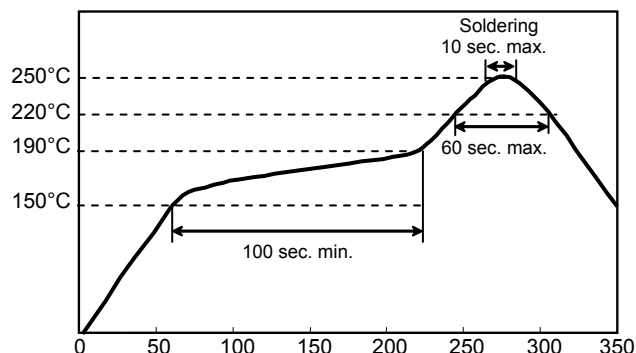

**FLOW SOLDERING**

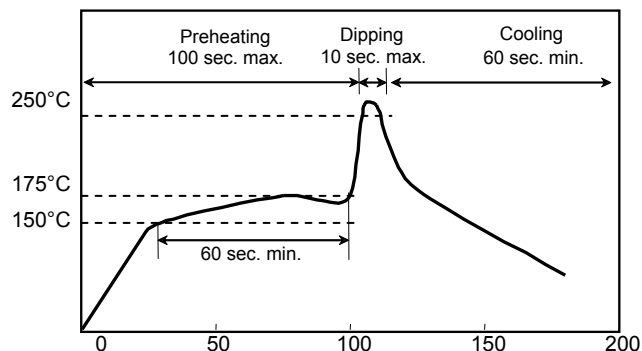

**MANUAL SOLDERING**

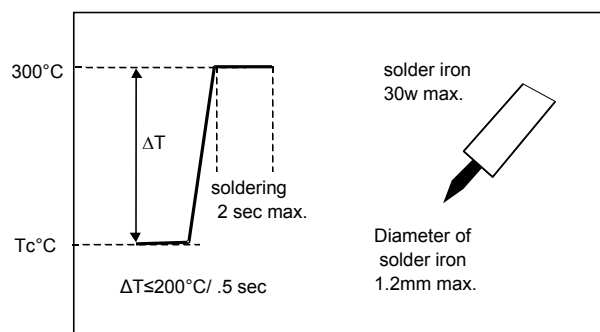

## Precaution for Storage

Electrical characteristics of product will not change when stored under typical environmental conditions. However, it is possible that the solderability of terminal electrodes and the characteristics of the tape packaging can change during storage. For this reason, the following storage guidelines should be followed.

1. Storage Environment: The tape packaging material is designed to withstand long-term storage but they will degrade more rapidly in the presence of high temperature or high humidity. Therefore, product shall be stored in an ambient temperature of less than 40°C with a relative humidity of less than 70%. The products should be used within 6 months of receipt. To achieve best solderability, product should be used as soon as possible after unpacking. Leftover product must be stored in dry condition with desiccant.
2. Corrosive gases: Since sulfur and chlorine may degrade the solderability of the terminal electrodes, it is important to store the product in an environment free of such gases.
3. Temperature fluctuations: Dew condensation may occur when the product is taken out of storage due to variation of temperature. It is important to maintain a temperature-controlled environment.

DISCLAIMER: The names of the products and the specifications in this catalog are subject to change without notice for the sake of improvement. World Products Inc. also reserves the right to discontinue any of these products. The products in this catalog are intended for use in ordinary electronic products. If any of these products are to be used in special applications requiring extremely high reliability, where product defects might pose a safety risk, please consult World Products Inc. Though World Products Inc. has taken all possible precautions to ensure the quality and reliability of its products, improper use of products may result in bodily injury, fire, or similar accident. If you have any questions regarding the use of the products in question, please consult World Products Inc. Please be advised that World Products Inc. accepts no responsibility for any infringement by users of World Products Inc. products on third party patents or industrial copyrights.