

QUAD BUS TRANSCEIVER; 3-STATE

FEATURES

- Non-inverting 3-state outputs
- 2-way asynchronous data bus communication
- Output capability: bus driver
- I_{CC} category: MSI

GENERAL DESCRIPTION

The 74HC/HCT243 are high-speed Si-gate CMOS devices and are pin compatible with low power Schottky TTL (LSSTTL). They are specified in compliance with JEDEC standard no. 7A.

The 74HC/HCT243 are quad bus transceivers featuring non-inverting 3-state bus compatible outputs in both send and receive directions. They are designed for 4-line asynchronous 2-way data communications between data buses.

The output enable inputs (\overline{OE}_A and \overline{OE}_B) can be used to isolate the buses.

The "243" is similar to the "242" but has non-inverting (true) outputs.

SYMBOL	PARAMETER	CONDITIONS	TYPICAL		UNIT
			HC	HCT	
t_{PHL}/t_{PLH}	propagation delay A_n to B_n ; B_n to A_n	$C_L = 15 \text{ pF}$ $V_{CC} = 5 \text{ V}$	6	11	ns
C_i	input capacitance		3.5	3.5	pF
$C_{I/O}$	input/output capacitance		10	10	pF
C_{PD}	power dissipation capacitance per transceiver	notes 1 and 2	26	34	pF

GND = 0 V; T_{amb} = 25 °C; t_r = t_f = 6 ns

Notes

1. C_{PD} is used to determine the dynamic power dissipation (P_D in μW):

$$P_D = C_{PD} \times V_{CC}^2 \times f_i + \Sigma (C_L \times V_{CC}^2 \times f_o) \text{ where:}$$

- f_i = input frequency in MHz
- f_o = output frequency in MHz
- $\Sigma (C_L \times V_{CC}^2 \times f_o)$ = sum of outputs
- C_L = output load capacitance in pF
- V_{CC} = supply voltage in V

2. For HC the condition is $V_I = \text{GND to } V_{CC}$
For HCT the condition is $V_I = \text{GND to } V_{CC} - 1.5 \text{ V}$

PACKAGE OUTLINES

SEE PACKAGE INFORMATION SECTION

PIN DESCRIPTION

PIN NO.	SYMBOL	NAME AND FUNCTION
1	\overline{OE}_A	output enable input (active LOW)
2, 12	n.c.	not connected
3, 4, 5, 6	A_0 to A_3	data inputs/outputs
7	GND	ground (0 V)
11, 10, 9, 8	B_0 to B_3	data inputs/outputs
13	\overline{OE}_B	output enable input
14	V_{CC}	positive supply voltage

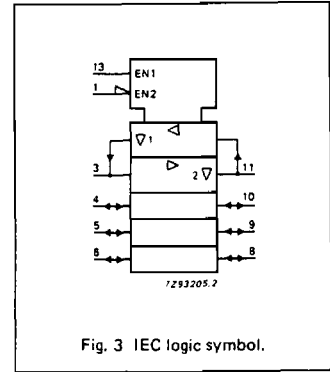
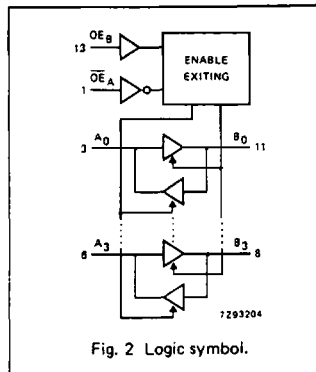
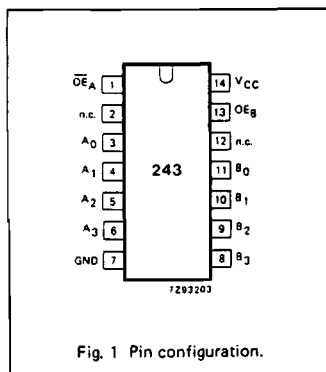

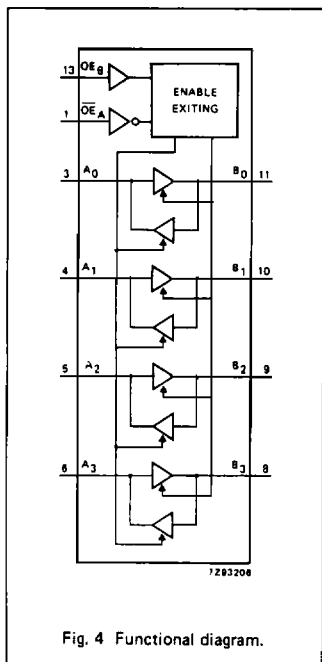

Fig. 4 Functional diagram.

FUNCTION TABLE

INPUTS		INPUTS/OUTPUTS	
\overline{OE}_A	OE_B	A_n	B_n
L	L	inputs	$B = A$
H	L	Z	Z
L	H	Z	Z
H	H	$A = B$	inputs

H = HIGH voltage level
 L = LOW voltage level
 Z = high impedance OFF-state

DC CHARACTERISTICS FOR 74HC

For the DC characteristics see chapter "HCMOS family characteristics", section "Family specifications".

Output capability: bus driver

I_{CC} category: MSI

AC CHARACTERISTICS FOR 74HC

GND = 0 V; t_r = t_f = 6 ns; C_L = 50 pF

SYMBOL	PARAMETER	T _{amb} (°C)						UNIT	TEST CONDITIONS	
		74HC							V _{CC} V	WAVEFORMS
		+25			-40 to +85		-40 to +125			
		min.	typ.	max.	min.	max.	min.		max.	
t _{PHL} / t _{PLH}	propagation delay A _n to B _n ; B _n to A _n	22 8 6	90 18 15		115 23 20		135 27 23	ns	2.0 4.5 6.0	Fig. 5
t _{PZH} / t _{PZL}	3-state output enable time OE _A to A _n or B _n ; OE _B to A _n or B _n	50 18 14	150 30 26		190 38 33		225 45 38	ns	2.0 4.5 6.0	Figs 6 and 7
t _{PHZ} / t _{PLZ}	3-state output disable time OE _A to A _n or B _n ; OE _B to A _n or B _n	61 22 18	165 33 28		205 41 35		250 50 43	ns	2.0 4.5 6.0	Figs 6 and 7
t _{THL} / t _{TLH}	output transition time	14 5 4	60 12 10		75 15 13		90 18 15	ns	2.0 4.5 6.0	Fig. 5

DC CHARACTERISTICS FOR 74HCT

For the DC characteristics see chapter "HCMOS family characteristics", section "Family specifications".

Output capability: bus driver

I_{CC} category: MSI

Note to HCT types

The value of additional quiescent supply current (ΔI_{CC}) for a unit load of 1 is given in the family specifications. To determine ΔI_{CC} per input, multiply this value by the unit load coefficient shown in the table below.

INPUT	UNIT LOAD COEFFICIENT
A _n	1.10
B _n	1.10
OE _A	1.00
OE _B	1.00

AC CHARACTERISTICS FOR 74HCT

GND = 0 V; t_r = t_f = 6 ns; C_L = 50 pF

SYMBOL	PARAMETER	T _{amb} (°C)						UNIT	TEST CONDITIONS		
		74HCT							V _{CC} V	WAVEFORMS	
		+25			-40 to +85		-40 to +125				
		min.	typ.	max.	min.	max.	min.				max.
t _{PHL} / t _{PLH}	propagation delay A _n to B _n ; B _n to A _n		13	22		28		33	ns	4.5	Fig. 5
t _{PZH} / t _{PZL}	3-state output enable time OE _A to A _n or B _n ; OE _B to A _n or B _n		18	34		43		51	ns	4.5	Figs 6 and 7
t _{PHZ} / t _{PLZ}	3-state output disable time OE _A to A _n or B _n ; OE _B to A _n or B _n		23	35		44		53	ns	4.5	Figs 6 and 7
t _{THL} / t _{TLH}	output transition time		5	12		15		18	ns	4.5	Fig. 5

AC WAVEFORMS

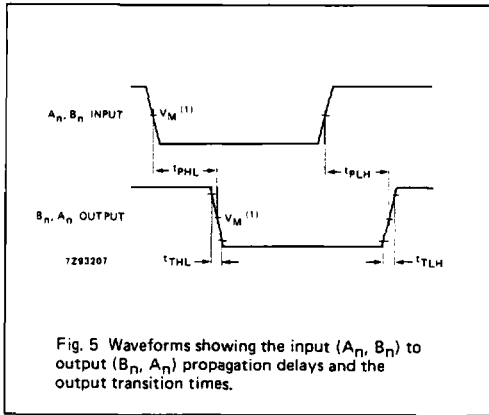

Fig. 5 Waveforms showing the input (A_n, B_n) to output (B_n, A_n) propagation delays and the output transition times.

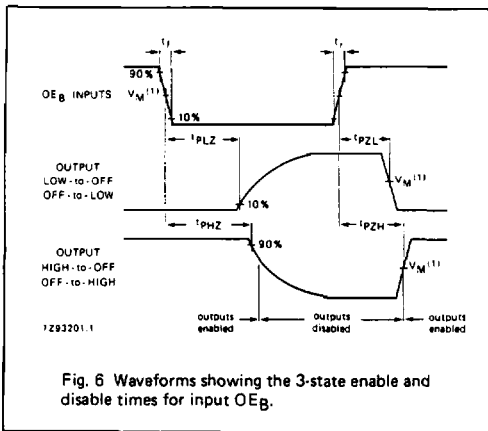

Fig. 6 Waveforms showing the 3-state enable and disable times for input OE_B.

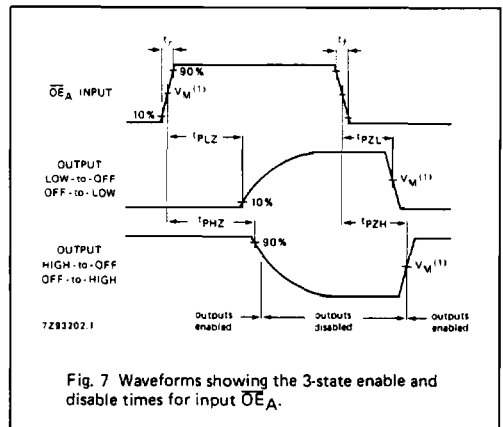

Fig. 7 Waveforms showing the 3-state enable and disable times for input OE_A.

Note to AC waveforms

- (1) HC : V_M = 50%; V_I = GND to V_{CC}.
- HCT: V_M = 1.3 V; V_I = GND to 3 V.