

## RECEPTACLES WITH PIN CONTACTS, RIGHT ANGLE PCB TERMINATION, 790-041P

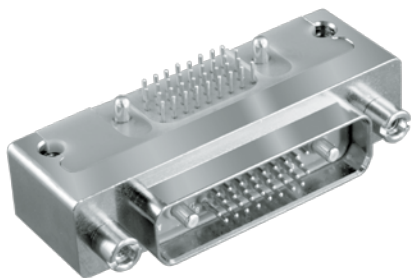

Lightweight, rugged right angle headers feature gold-plated contacts for thru-hole printed circuit board termination. 790-041P connectors are free-standing (not for panel mounting) and mate to 790-025S cable plugs. Contacts are permanently installed and are sealed with epoxy. Shells are aluminum alloy. Threaded board mounting holes and integral standoffs simplify installation. EMI shroud improves EMI performance. Fluorosilicone face seal provides watertight interface. Available in 29 different contact arrangements, these connectors feature size #23 signal contacts along with #16 and #12 power contacts for up to 23 amps current rating.

### HOW TO ORDER

Sample Part Number

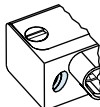
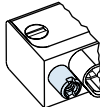
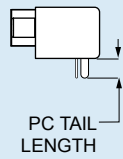
790-041P	J-25P2	M	P	A
Part Number	Shell Size - Insert Arr.	Shell Finish	Hardware Option	PC Tail Length
<p style="color: #0070C0; margin: 0;"><b>790-041P</b></p> <p style="margin: 0;">Header Receptacle with 90° PC Tail Pin Contacts for Termination to Backplanes or Flexible Circuits</p>	<p style="margin: 0;">See Table 1 for Available Insert Arrangements</p>	<p style="color: #0070C0; margin: 0; text-align: center;"><b>M</b></p> <p style="margin: 0;">Electroless Nickel <i>general purpose applications</i></p> <p style="color: #0070C0; margin: 0; text-align: center;"><b>MT</b></p> <p style="margin: 0;">Nickel-PTFE 1000 Hour Grey™ <i>maximum corrosion protection and durability (non-reflective grey)</i></p> <p style="color: #0070C0; margin: 0; text-align: center;"><b>ZNU</b></p> <p style="margin: 0;">Zinc-Nickel with Black Chromate <i>tactical applications (non-reflective black)</i></p> <p style="margin: 0; text-align: center;">Additional shell finishes are listed on page C-9.</p>	<div style="text-align: center;">   <p style="color: #0070C0; margin: 0;"><b>N</b></p> <p style="margin: 0;">No Hardware</p> </div> <div style="text-align: center; margin-top: 20px;">   <p style="color: #0070C0; margin: 0;"><b>P</b></p> <p style="margin: 0;">Female Jackpost</p> </div>	<div style="text-align: center;"> <p style="color: #0070C0; margin: 0;"><b>A</b></p> <p style="margin: 0;">.125 Inch (3.2 mm.)</p> </div> <div style="text-align: center; margin-top: 20px;"> <p style="color: #0070C0; margin: 0;"><b>B</b></p> <p style="margin: 0;">.250 inch (6.4 mm.)</p>  <p style="margin: 0; font-size: small;">PC TAIL LENGTH</p> </div>

### SPECIFICATIONS

Current Rating	#23 5 AMPS, #16 13 A., #12 23 A.
Dielectric Withstanding Voltage	#23 500 VAC RMS, #12 and #16 1800 VAC RMS
Insulation Resistance	5000 megohms minimum
Operating Temperature	-65° C. to +150° C.
Shock	300 g.
Vibration	37 g.

### MATERIALS AND FINISHES

Shell	Aluminum alloy
Contacts	Copper alloy, 50 microinches gold plated
Insulator	Liquid crystal polymer (LCP)
EMI Shroud	Aluminum alloy
Interfacial Seal	Fluorosilicone rubber
Jackposts	300 series stainless steel
Tray	Thermoplastic
Encapsulant	Epoxy

Dimensions in inches (millimeters) and are subject to change without notice.

# Series 79 Micro-Crimp Section G: Right Angle Printed Circuit Board Connectors



**Table 1 Contact Arrangements**

Layout	Contact Quantity		Face View
	#23	#16#12	
A-5	5		
B-2P2	2		
B-9	9		
C-13	13		
D-15	15		
D-3P3	3		
D-7P2	5	2	
E-11P2	9	2	
E-19	19		
E-7P3	4	3	
F-15P2	13	2	
F-23	23		
F-5P5	5		
G-33	33		
H-10P4	6	4	
H-29P7	22	7	
H-36P2	34	2	
H-54P2	52	2	
H-5P5		5	
H-66	66		
J-17P4	13	4	
J-25P2	23	2	
J-33	33		
J-7P7		7	
K-27P4	23	4	
K-35P2	33	2	
K-43	43		
K-9P9		9	
L-6P6		6	

**CROSS-SECTIONAL VIEW OF 790-041P**

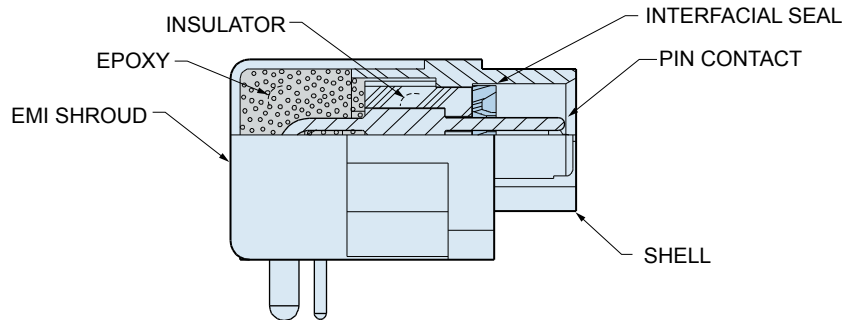

**TABLE 2 HARDWARE OPTION**

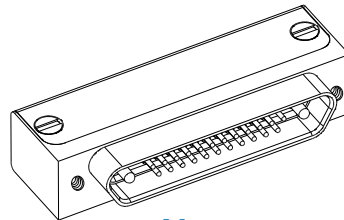

**N**

**No Mating Hardware**

Connector is supplied with threaded holes. Shell sizes H and L have #6-32 threads, other sizes have #4-40 threads. Thread depth is .150" (3.8).

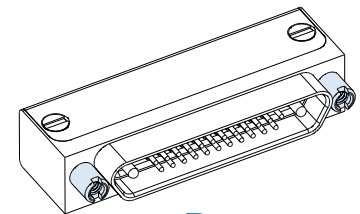

**P**

**Jackposts**

Connector is supplied with non-removable stainless steel jackposts. Shell sizes H and L have #4-40 UNC thread, other sizes have #2-56 thread.

Dimensions in inches (millimeters) and are subject to change without notice.

790-041P DIMENSIONS: SHELL SIZES A-F, J, AND K

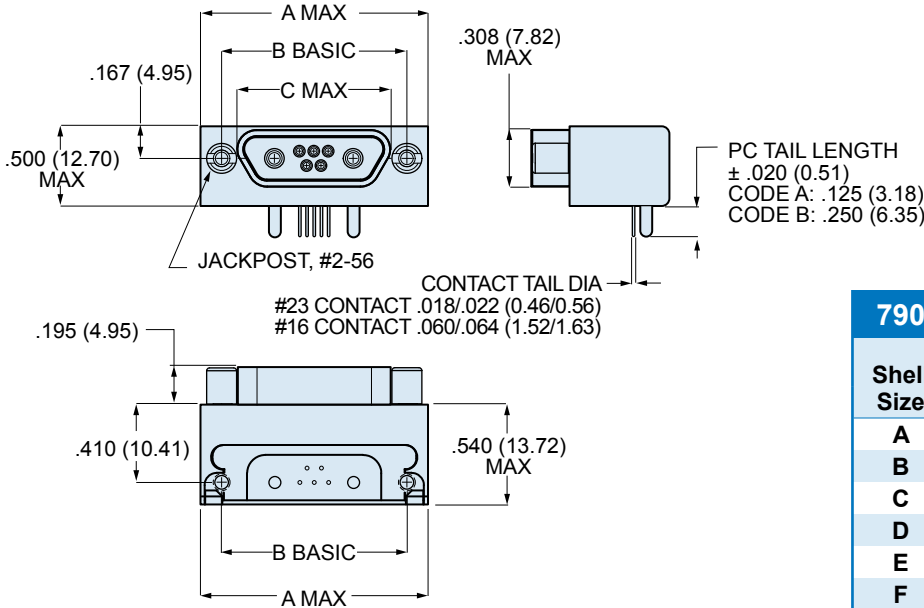

790-041P SHELL SIZES A-F, J AND K

Shell Size	A Max.		B Basic		C Max.	
	In.	mm.	In.	mm.	In.	mm.
A	.805	20.45	.565	14.35	.401	10.19
B	.955	24.26	.715	18.16	.551	14.00
C	1.105	28.07	.865	21.97	.701	17.81
D	1.205	30.61	.965	24.51	.801	20.35
E	1.355	34.42	1.115	28.32	.951	24.16
F	1.505	38.23	1.265	32.13	1.101	27.96
J	1.855	47.12	1.615	41.02	1.456	36.98
K	2.255	57.28	2.015	51.18	1.860	47.24

790-041P DIMENSIONS: SHELL SIZE G

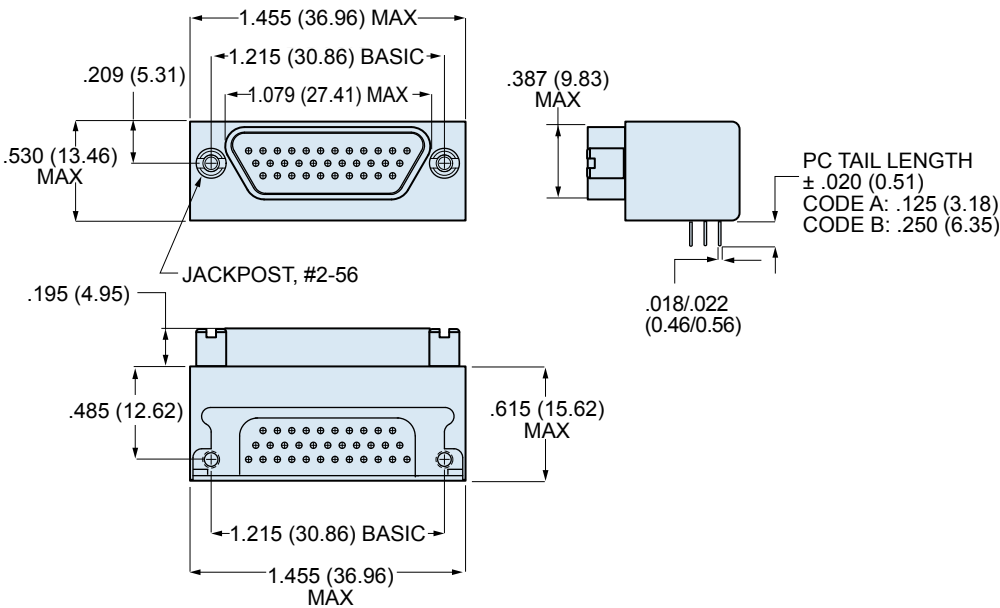

Dimensions in inches (millimeters) and are subject to change without notice.

# Series 79 Micro-Crimp Section G: Right Angle Printed Circuit Board Connectors



## 790-041P DIMENSIONS: SHELL SIZES H & L

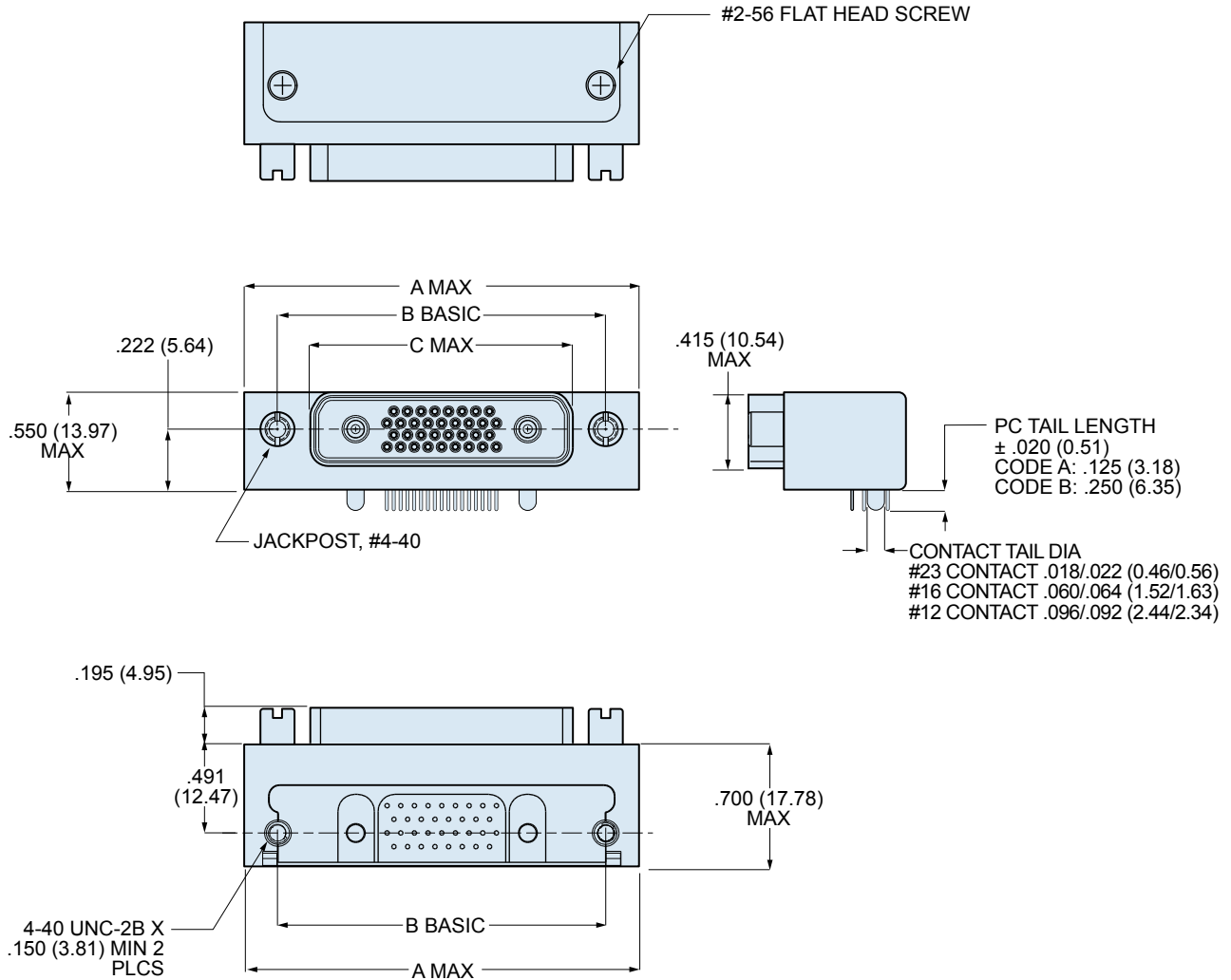

790-041P SHELL SIZES H AND L

Shell Size	A Max.		B Basic		C Max.	
	In.	mm.	In.	mm.	In.	mm.
H	2.185	55.50	1.800	45.72	1.450	36.83
L	2.430	61.72	2.036	51.71	1.686	42.82

Dimensions in inches (millimeters) and are subject to change without notice.