

VERY LOW IMPEDANCE (LOWER THAN NRSZ) AT HIGH FREQUENCY
 RADIAL LEADS, POLARIZED ALUMINUM ELECTROLYTIC CAPACITORS

FEATURES

- VERY LOW IMPEDANCE
- LONG LIFE AT 105°C (2000 ~ 7000 hrs.)
- HIGH STABILITY AT LOW TEMPERATURE
- IDEALLY FOR SWITCHING POWER SUPPLIES

RoHS Compliant
 includes all homogeneous materials

*See Part Number System for Details

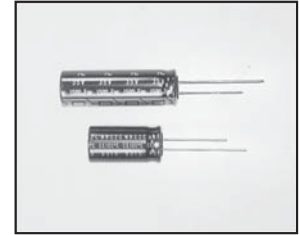

CHARACTERISTICS

Rated Voltage Range	6.3 ~ 35VDC					
Capacitance Range	47 ~ 18,000µF					
Operating Temperature Range	-55 ~ +105°C					
Capacitance Tolerance	±20% (M)					
Max. Leakage Current @ 20°C after 2 min.	0.01CV					
Max. Tanδ ~ 120Hz/20°C	W.V. (VDC)	6.3	10	16	25	35
	S.V. (VDC)	8	13	20	32	44
	C < 1,000µF	0.22	0.19	0.16	0.14	0.12
	C = 1,800µF	0.22	0.19	0.16	0.14	0.12
	C = 2,200µF	0.24	-	0.18	0.16	0.14
	C = 2,700µF	0.24	0.21	0.18	0.16	0.14
	C = 3,300µF	-	-	0.20	0.18	0.16
	C = 3,900µF	0.26	0.23	0.20	0.18	0.16
	C = 4,700µF	0.28	0.26	0.22	-	0.18
	C = 5,600µF	0.30	0.27	0.24	0.22	-
	C = 6,800µF	0.32	0.29	0.26	0.24	-
	C = 8,200µF	0.36	0.33	0.30	-	-
	C = 10,000µF	0.40	0.37	0.34	-	-
	C = 12,000µF	0.44	0.41	-	-	-
C = 15,000µF	0.50	0.47	-	-	-	
C = 18,000µF	0.56	-	-	-	-	
Low Temperature Stability Impedance Ratio @ 120Hz	Z-25°C/Z+20°C	3	2	2	2	2
	Z-40°C/Z+20°C	4	4	3	3	3
Load Life Test at Rated W.V. & 105°C 7,000 Hours: 16 ~ 18φ 5,000 hours: 12.5φ 4,000 hours: 10φ 3,000 hours: 8φ 2,000 hours: 5 ~ 6.3φ	Capacitance Change	Within ±25% of initial measured value				
	Tanδ	Less than 200% of specified maximum value				
	Leakage Current	Less than specified maximum value				
Shelf Life Test 105°C for 1,000 hours No Load	Capacitance Change	Within ±20% of initial measured value				
	Tanδ	Less than 200% of specified maximum value				
	Leakage Current	Less than specified maximum value				

NRSZ → NRSZC
 (today's standard) (for new designs)

PART NUMBER SYSTEM

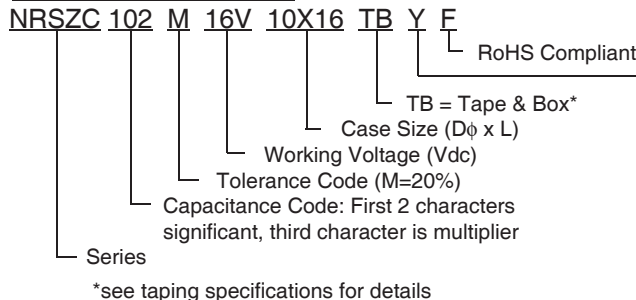

Optional: For automotive equipment, sourced to special production and inspection at TS-16949 certified production site.

PRECAUTIONS

Please review the notes on correct use, safety and precautions found on pages T10 & T11 of NIC's Electrolytic Capacitor catalog.
 Also found at www.niccomp.com/precautions
 If in doubt or uncertainty, please review your specific application - process details with NIC's technical support personnel: tpmg@niccomp.com



STANDARD PRODUCTS, CASE SIZES AND SPECIFICATIONS

Part Number	Cap. (µF)	W.V. (Vdc)	Max. Tanδ	Max. LC (µA)	Max. Impedance	Max. Ripple Current at 100KHz/105°C (mA rms)	Load Life Hours @ +105°C	
					100KHz/20°C			
NRSZC181M6.3V5x11F	180	6.3	0.22	11.3	0.340	205	2,000	
NRSZC331M6.3V6.3x11F	330		0.22	20.8	0.170	330	2,000	
NRSZC391M6.3V6.3x11F	390		0.22	24.6	0.170	330	2,000	
NRSZC681M6.3V8x11.5F	680		0.22	42.8	0.110	580	3,000	
NRSZC102M6.3V8x15F	1000		0.22	63.0	0.080	750	3,000	
NRSZC122M6.3V8x20F	1200		0.22	75.6	0.060	1000	3,000	
NRSZC122M6.3V10x12.5F			0.22	75.6	0.063	900	4,000	
NRSZC152M6.3V8x20F	1500		0.22	94.5	0.060	1000	3,000	
NRSZC152M6.3V10x16F			0.22	94.5	0.049	1200	4,000	
NRSZC222M6.3V10x20F	2200		0.24	138.6	0.036	1450	4,000	
NRSZC272M6.3V10x22F	2700		0.24	170.1	0.036	1500	4,000	
NRSZC392M6.3V12.5x20F	3900		0.26	245.7	0.035	1660	5,000	
NRSZC472M6.3V12.5x25F	4700		0.28	296.1	0.027	2000	5,000	
NRSZC562M6.3V12.5x25F	5600		0.30	352.8	0.027	2000	5,000	
NRSZC562M6.3V16x21F			0.30	352.8	0.032	2000	7,000	
NRSZC682M6.3V12.5x30F	6800		0.32	428.4	0.24	2450	5,000	
NRSZC682M6.3V16x25F			0.32	428.4	0.022	2560	7,000	
NRSZC822M6.3V16x25F	8200		0.36	516.6	0.022	2560	7,000	
NRSZC103M6.3V16x25F	10000		0.40	630.0	0.17	3010	7,000	
NRSZC103M6.3V18x25F			0.40	630.0	0.022	2740	7,000	
NRSZC123M6.3V16x35.5F	12000		0.44	756.0	0.016	3150	7,000	
NRSZC123M6.3V18x30.5F			0.44	756.0	0.17	3330	7,000	
NRSZC153M6.3V18x35.5F	15000		0.50	945.0	0.016	3680	7,000	
NRSZC151M10V5x11F	150		10	0.19	15.0	0.340	205	2,000
NRSZC271M10V6.3x11F	270			0.19	27.0	0.170	330	2,000
NRSZC471M10V8x11.5F	470			0.19	47.0	0.110	580	3,000
NRSZC561M10V8x11.5F	560			0.19	56.0	0.110	580	3,000
NRSZC681M10V8x15F	680			0.19	68.0	0.080	750	3,000
NRSZC821M10V10x12.5F	820	0.19		82.0	0.063	900	4,000	
NRSZC102M10V8x20F	1000	0.19		100.0	0.060	1000	3,000	
NRSZC102M10V10x16F		0.19		100.0	0.049	1200	4,000	
NRSZC122M10V10x16F	1200	0.19		120.0	0.049	1200	4,000	
NRSZC152M10V10x20F	1500	0.19		150.0	0.036	1450	4,000	
NRSZC182M10V10x22F	1800	0.19		180.0	0.036	1500	4,000	
NRSZC272M10V12.5x20F	2700	0.21		270.0	0.035	1660	5,000	
NRSZC392M10V12.5x25F	3900	0.23		390.0	0.027	2000	5,000	
NRSZC392M10V16x21F		0.23		390.0	0.032	2000	7,000	
NRSZC472M10V12.5x30F	4700	0.25		470.0	0.024	2450	5,000	
NRSZC472M10V16x25F		0.25		470.0	0.022	2560	7,000	
NRSZC562M10V16x25F	5600	0.27		560.0	0.022	2560	7,000	
NRSZC562M10V18x21F		0.27		560.0	0.030	2490	7,000	
NRSZC682M10V16x31.5F	6800	0.29		680.0	0.017	3010	7,000	
NRSZC682M10V18x25F		0.29		680.0	0.022	2740	7,000	
NRSZC822M10V16x31.5F	8200	0.33		820.0	0.017	3010	7,000	
NRSZC103M10V16x35.5F	10000	0.37		1000	0.016	3150	7,000	
NRSZC103M10V18x30.5F		0.37		1000	0.017	3330	7,000	
NRSZC123M10V18x35.5F	12000	0.41		1200	0.016	3680	7,000	

For Automotive Applications see part number system



STANDARD PRODUCTS, CASE SIZES AND SPECIFICATIONS

Part Number	Cap. (μF)	W.V. (Vdc)	Max. Tanδ	Max. LC (μA)	Max. Impedance	Max. Ripple Current at 100KHz/105°C (mA rms)	Load Life Hours @ +105°C	
					100KHz/20°C			
NRSZC101M16V5x11F	100	16	0.16	16.0	0.340	205	2,000	
NRSZC181M16V6.3x11F	180		0.16	28.8	0.170	330	2,000	
NRSZC331M16V8x11.5F	330		0.16	52.8	0.110	580	3,000	
NRSZC471M16V8x15F	470		0.16	75.2	0.080	750	3,000	
NRSZC561M16V10x12.5F	560		0.16	89.6	0.063	900	4,000	
NRSZC681M16V8X20F	680		0.16	108.8	0.060	1000	3,000	
NRSZC821M16V10X16F	820		0.16	131.2	0.049	1200	4,000	
NRSZC102M16V10X20F	1000		0.16	160.0	0.036	1450	4,000	
NRSZC122M16V10X22F	1200		0.16	192.0	0.036	1500	4,000	
NRSZC152M16V12.5X20F	1500		0.16	240.0	0.035	1660	5,000	
NRSZC182M16V12.5X20F	1800		0.16	288.0	0.035	1660	5,000	
NRSZC222M16V12.5X25F	2200		0.18	352.0	0.027	2000	5,000	
NRSZC272M16V12.5X25F	2700		0.18	432.0	0.027	2000	5,000	
NRSZC272M16V16X21F			0.18	432.0	0.032	2000	7,000	
NRSZC332M16V12.5x30F	3300		0.20	528.0	0.024	2450	5,000	
NRSZC332M16V16x25F			0.20	528.0	0.022	2560	7,000	
NRSZC332M16V18x21F			0.20	528.0	0.030	2490	7,000	
NRSZC392M16V16x25F	3900		0.20	624.0	0.022	2560	7,000	
NRSZC472M16V16x31.5F	4700		0.22	752.0	0.017	3010	7,000	
NRSZC472M16V18x25F			0.22	752.0	0.022	2740	7,000	
NRSZC562M16V16x31.5F	5600		0.24	896.0	0.017	3010	7,000	
NRSZC682M16V16x35.5F	6800		0.26	1088	0.016	3150	7,000	
NRSZC822M16V18x35.5F	8200		0.30	1312	0.016	3680	7,000	
NRSZC680M25V5x11F	68		25	0.14	17.0	0.340	205	2,000
NRSZC121M25V6.3x11F	120			0.14	30.0	0.170	330	2,000
NRSZC221M25V8x11.5F	220			0.14	55.0	0.110	580	3,000
NRSZC331M25V8x15F	330			0.14	82.5	0.080	750	3,000
NRSZC391M25V10x12.5F	390			0.14	97.5	0.063	900	4,000
NRSZC471M25V8x20F	470	0.14		117.5	0.060	1000	3,000	
NRSZC561M25V10x16F	560	0.14		140.0	0.049	1200	4,000	
NRSZC681M25V10x20F	680	0.14		170.0	0.036	1450	4,000	
NRSZC821M25V10x20F	820	0.14		205.0	0.036	1450	4,000	
NRSZC102M25V10x22F	1000	0.14		250.0	0.036	1500	4,000	
NRSZC122M25V12.5x20F	1200	0.14		300.0	0.035	1660	5,000	
NRSZC182M25V12.5x25F	1800	0.14		450.0	0.027	2000	5,000	
NRSZC182M25V16x25F		0.14		450.0	0.032	2000	7,000	
NRSZC222M25V12.5x30F	2200	0.16		550.0	0.024	2450	5,000	
NRSZC222M25V18x21F		0.16		550.0	0.030	2490	7,000	
NRSZC272M25V16x25F	2700	0.16		675.0	0.022	2560	7,000	
NRSZC332M25V16x31.5F	3300	0.18		825.0	0.017	3010	7,000	
NRSZC332M25V18x25F		0.18		825.0	0.022	2740	7,000	
NRSZC392M25V16x35.5F	3900	0.18		975.0	0.016	3150	7,000	
NRSZC392M25V18x30.5F		0.18		975.0	0.017	3330	7,000	
NRSZC562M25V18x35.5F	5600	0.22		1400	0.016	3680	7,000	

For Automotive Applications see part number system



STANDARD PRODUCTS, CASE SIZES AND SPECIFICATIONS

Part Number	Cap. (μF)	W.V. (Vdc)	Max. Tanδ	Max. LC (μA)	Max. Impedance	Max. Ripple Current at 100KHz/105°C (mA rms)	Load Life Hours @ +105°C
					100KHz/20°C		
NRSZC470M35V5x11F	47	35	0.12	16.5	0.340	205	2,000
NRSZC101M35V6.3x11F	100		0.12	35.0	0.170	330	2,000
NRSZC151M35V8x11.5F	150		0.12	52.5	0.110	580	3,000
NRSZC221M35V8x15F	220		0.12	77.0	0.080	750	3,000
NRSZC271M35V10x12.5F	270		0.12	94.5	0.063	900	4,000
NRSZC331M35V8x20F	330		0.12	115.5	0.060	1000	3,000
NRSZC331M35V10x16F			0.12	115.5	0.049	1200	4,000
NRSZC391M35V10x16F	390		0.12	136.5	0.049	1200	4,000
NRSZC471M35V10x20F	470		0.12	164.5	0.036	1450	4,000
NRSZC561M35V10x20F	560		0.12	196.0	0.036	1450	4,000
NRSZC681M35V10x22F	680		0.12	238.0	0.036	1500	4,000
NRSZC821M35V12.5x20F	820		0.12	287.0	0.035	1660	5,000
NRSZC122M35V12.5x25F	1200		0.12	420.0	0.027	2000	5,000
NRSZC122M35V16x21F			0.12	420.0	0.032	2000	7,000
NRSZC152M35V12.5x30F	1500		0.12	525.0	0.024	2450	5,000
NRSZC152M35V18x21F			0.12	525.0	0.030	2490	7,000
NRSZC182M35V16x25F	1800		0.12	630.0	0.022	2560	7,000
NRSZC222M35V18x25F	2200		0.14	770.0	0.022	2740	7,000
NRSZC272M35V16x31.5F	2700		0.14	945.0	0.017	3010	7,000
NRSZC332M35V16x35.5F	3300		0.16	1155	0.016	3150	7,000
NRSZC392M35V18x35.5F	3900	0.16	1365	0.016	3680	7,000	

For Automotive Applications see part number system

RIPPLE CURRENT CORRECTION FACTORS

Frequency (Hz)	Cap. (μF)	120	1K	10K	100K
Multiplier	47 ~ 68	0.50	0.80	1.00	1.00
	100 ~ 220	0.55	0.85	1.00	1.00
	270 ~ 1000	0.65	0.90	1.00	1.00
	1200 ~ 18000	0.75	0.90	1.00	1.00

LEAD SPACING AND DIAMETER (mm)

Case Dia. (Dφ)	5	6.3	8	10	12.5	12.5x30	16	18
Lead Dia. (dφ)	0.5	0.5	0.6	0.6	0.6	0.8	0.8	0.8
Lead Spacing (F)	2.0	2.5	3.5	5.0	5.0	5.0	7.5	7.5
Dim. α	0.5							

$\beta = L < 20\text{mm} = 1.5\text{mm}, L \geq 20\text{mm} = 2.0\text{mm}$

DIMENSIONS (mm)

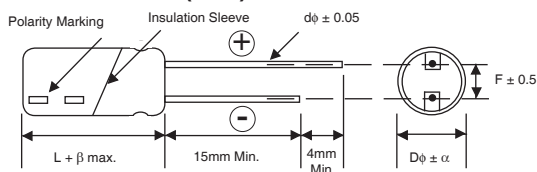

Drawing is representative of parts as supplied in bulk or straight lead format, please see taping specification for details on taped format packaging.

Miniature Aluminum Electrolytic Capacitors Taping Specifications

STANDARD RADIAL TAPING (5mm LEAD SPACING, FORMED LEADS) TB

Taping Dimensions (mm)

Case Dia. (D ϕ)	4			5			6.3			8		
Case Size	4x5	5x5	5x11	6.3x5	6.3x7	6.3x11	8x11.5					
Dim.	4x7	5x7	5x11	6.3x7	6.3x11	6.3x11	8x11.5					
d ϕ \pm 0.05	0.45	0.45	0.5	0.45	0.5	0.5	0.6					
H \pm 0.75	17.5	17.5	18.5	17.5	18.5	18.5	20.0					
F +0.8 ~ -0.2				5.0 -0.2 ~ +0.8								
P				12.7 \pm 1.0								
P ₀				12.7 \pm 0.2								
P ₁				3.85 \pm 0.5 (at end of tape)								
P ₂				6.35 \pm 1.0								
W				18.0 \pm 0.5								
W ₀				11.5 min.								
W ₁				9.0 \pm 0.5								
W ₂				0 ~ 2.5								
H ₀				16.0 \pm 0.5								
l				1.0 max.								
D ₀ ϕ				4.0 \pm 0.2								
Δ h				0 \pm 1.0 (at top of can)								
t				0.7 \pm 0.2 (not including lead)								

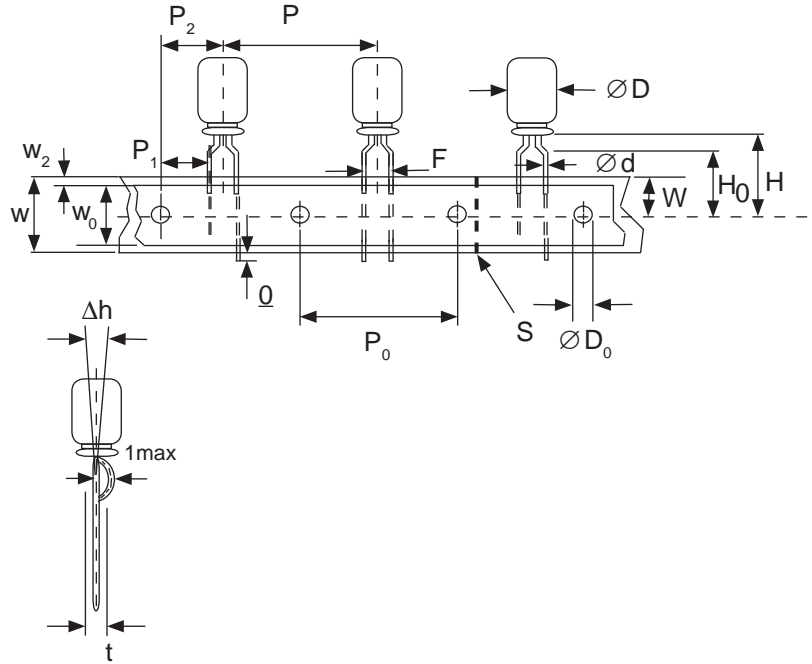

STANDARD RADIAL TAPING (5mm LEAD SPACING, STRAIGHT LEADS) TB

Taping Dimensions (mm)

Case Dia. (D ϕ)	10	12.5
Case Size	All	All
Dim.	All	All
d ϕ \pm 0.05	0.6	0.6
H \pm 0.75	19.0	19.0
F +0.8 ~ -0.2	5.0	5.0
P \pm 1.0	25.4*	
P ₀	12.7 \pm 0.2	
P ₁	3.85	
P ₂	6.35 \pm 1.0	
W	18.0 \pm 0.5	
W ₀	11.5 min	
W ₁	9.0 \pm 0.5	
W ₂	0 ~ 2.5	
H ₀	16.0 \pm 0.5	
l	1.0 max.	
D ₀ ϕ	4.0 \pm 0.2	
Δ h	0 \pm 1.0 (at top of can)	
t	0.7 \pm 0.2 (not including lead)	
*Optional Taping Specifications		
10mm diameter available with P dim. = 12.7mm (P/N Suffix: TB12.7MMP)		
12.5mm diameter available with P dim. = 15mm, P ₁ = 5.0mm, P ₀ = 15.0mm & P ₂ = 7.5mm (P/N Suffix: TB15MMP)		

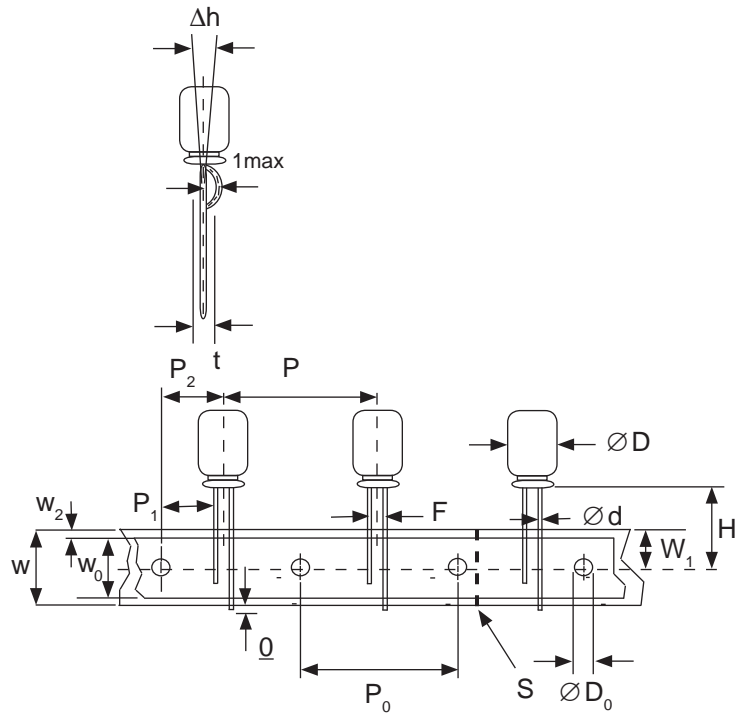

NOTE: ANODE (+) LEAD FEEDS OFF FIRST. FOR OPTION OF NEGATIVE (-) LEAD FIRST, SPECIFY "TBN".



SPECIAL RADIAL TAPING (2.5mm LEAD SPACING, FORMED LEADS) TBF1

Taping Dimensions (mm)

Case Dia. (D ϕ)	4		5	
Case Size Dim.	4x5 4x7	5x5 5x7	5x11	
d ϕ \pm 0.05	0.45	0.45	0.5	
H \pm 0.75	17.5	17.5	18.5	
H ₀ \pm 0.5	16.0	-	-	
F	2.5 -0.2 ~ +0.8			
P	12.7 \pm 1.0			
P ₀	12.7 \pm 0.2			
P ₁	5.1 \pm 0.5			
P ₂	6.35 \pm 1.0			
W	18.0 \pm 0.5			
W ₀	11.5 min.			
W ₁	9.0 \pm 0.5			
W ₂	0 ~ 1.5			
l	1.0 max.			
D ₀ ϕ	4.0 \pm 0.2			
Δ h	0 \pm 1.0			
t	0.7 \pm 0.2			

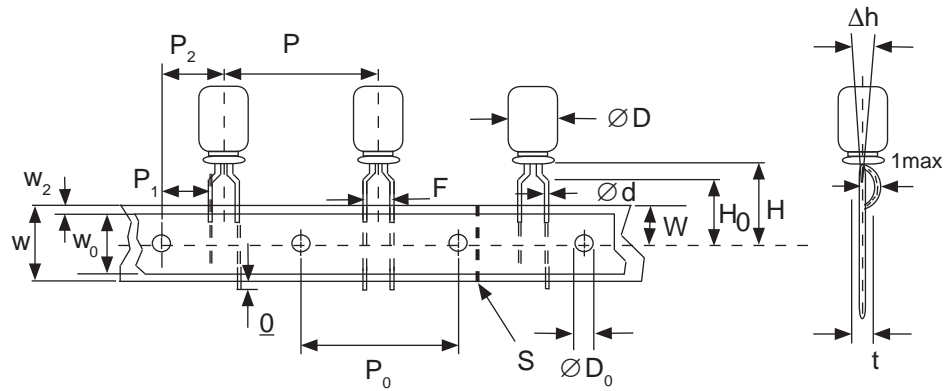

SPECIAL STRAIGHT LEAD TAPING TBST

Taping Dimensions (mm)

Case Dia. (D ϕ)	4			5			6.3		8	
Case Size Dim.	4x5 4x7	5x5 5x7	5x11		6.3x5 6.3x7	6.3x11	8x11.5			
d ϕ \pm 0.05	0.45	0.45	0.5	0.45	0.5	0.6				
H \pm 0.75	17.5	17.5	18.5	17.5	18.5	20.0				
F +0.8 ~ -0.2	2.0*	2.0	2.0	2.5	2.5	3.5				
P \pm 1.0	12.7 \pm 0.2									
P ₀	12.7 \pm 0.2									
P ₁	5.1	5.1	5.1	5.1	5.1	4.6				
P ₂	6.35 \pm 1.0									
W	18.0 \pm 0.5									
W ₀	11.5 min.									
W ₁	9.0 \pm 0.5									
W ₂	0 ~ 2.5									
H ₀	16.0 \pm 0.5									
l	1.0 max.									
D ₀ ϕ	4.0 \pm 0.2									
Δ h	0 \pm 1.0 (at top of can)									
t	0.7 \pm 0.2 (not including lead)									

* Parts with 4mm diameter are taped with a slight flare in the lead and a 2.0mm lead-space.

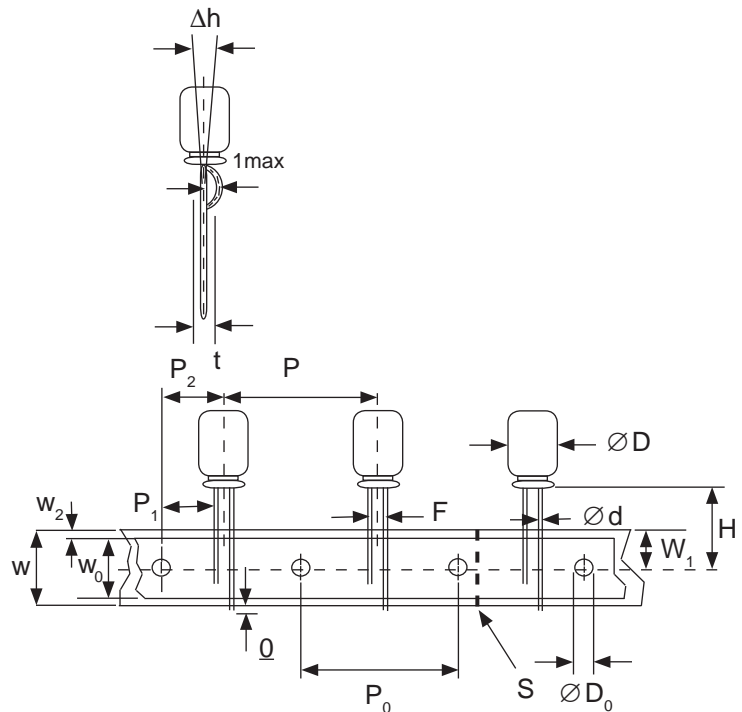

RADIAL TAPED PACKAGING

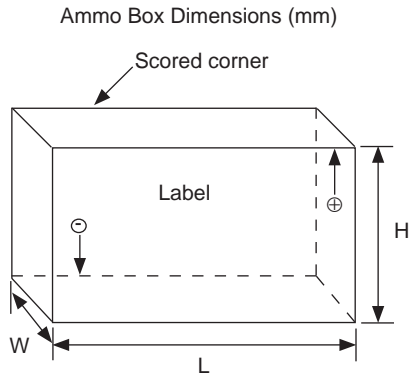

Ammo Box (Tape & Box) TB, TBF1, TBST

Size of box and component quantity

Case Dia (D ϕ) or Case Size	Q'ty per Box (pcs)	Dim. L	Dim. H	Dim. W
4x5, 4x7	2,000	331	175	43
5x5, 5x7	2,000	331	220	43
5x11	2,000	340	255	55
6.3x5, 6.3x7	2,000	331	280	43
6.3x11	2,000	331	280	48
8x11.5, 8x12.5	1,000	335	235	53
10x12.5*	500	335	190	53
10x16*	500	335	300	53
10x20*	500	335	300	55
12.x20*	500	335	300	55
12.5x25*	500	335	300	61

*Special Taping Consult Factory For Availability