



TECHNICAL REFERENCE NOTES (AA20C)

AA20C-048L SERIES

THIS SPECIFICATION COVERS THE REQUIREMENTS
FOR AA20C-048L-XXXS-X, 20W SWITCHING POWER SUPPLY WITH DC INPUT
RANGE FROM 36V TO 75V AND AN ISOLATED OUTPUT

MODEL NAME	SIS CODE	OUTPUT VOLTAGE / CURRENT	SERIAL NO. PREFIX
AA20C-048L-033S-M1	AA20C048SM02	3.3V / 6.0A	A585
AA20C-048L-050S	AA20C048S003	5.0V / 4.0A	A586
AA20C-048L-120S	AA20C048S004	12.0V / 1.67A	A587
AA20C-048L-050S-6	AA20C048S003-6	5.0V / 4.0A	A590
AA20C-048L-120S-6	AA20C048S004-6	12.0V / 1.67A	A591
AA20C-048L-050S-8	AA20C048S003-8	5.0V / 4.0A	A594
AA20C-048L-120S-8	AA20C048S004-8	12.0V / 1.67A	A595



TECHNICAL REFERENCE NOTES (AA20C)

Electrical Specifications

Unless otherwise indicated, specifications apply over all operating input voltage and temperature conditions.

ABSOLUTE MAXIMUM RATINGS

Stresses in excess of the absolute maximum ratings can cause permanent damage to the device. These are absolute stress ratings only. Functional operation of the device is not implied at these or any other conditions in excess of those given in the operational sections of the IPS. Exposure to absolute maximum ratings for extended periods can adversely affect device reliability.

Parameter	Device	Symbol	Min	Typ	Max	Unit
Input Voltage:						
Continuous:	All	V_I	0	-	75	Vdc
Transient (100ms)	All	$V_{I,trans}$	0	-	100	Vdc
Operating Case Temperature	All	T_c	-40	-	105	°C
Storage Temperature	All	T_{srg}	-40	-	125	°C
Operating Humidity	All	-	-	-	85	%
I/O Isolation (Input to Output)	All	-	-	-	1500	Vdc

INPUT SPECIFICATIONS

Parameter	Device	Symbol	Min	Typ	Max	Unit
Operating Input Voltage	All	V_I	36	48	75	Vdc
Maximum Input Current ¹ ($V_I = 0$ to $V_{I,max}$; $I_O = I_{O,max}$)	033S-MX	$I_{I,max}$	-	-	0.80	A
	050S-X	$I_{I,max}$	-	-	0.75	A
	120S-X	$I_{I,max}$	-	-	0.68	A
Input Reflected-ripple Current (5Hz to 20MHz; 12uH source Impedance; $T_A = 25$ °C.) See Figure 1.	All	I_r	-	-	15	mAp-p
No Load Input Power ($V_I = V_{I,nom}$)	All	-	-	-	0.35	W
Maximum Internal Input Capacitance	All	-	-	-	1.4	uF

Note: 1. This power module is not internally fused. The use of an input line fuse is recommended.



TECHNICAL REFERENCE NOTES (AA20C)

Electrical Specifications (continued)

OUTPUT SPECIFICATIONS

Parameter	Device	Symbol	Min	Typ	Max	Unit
Output Voltage Setpoint ($V_I = V_{I,min}$ to $V_{I,max}$; $I_O = I_{O,max}$ at $T_A = 25^\circ C$)	033S-MX	$V_{o,set}$	3.17	3.3	3.43	Vdc
	050S-X	$V_{o,set}$	4.92	5.0	5.08	Vdc
	120S-X	$V_{o,set}$	11.82	12.0	12.18	Vdc
Output Regulation Line ($V_I = V_{I,min}$ to $V_{I,max}$)	All	-	-	-	2	%
	All	-	-	-	2	%
	All	-	-	25	100	mV
Temperature ($T_c = -40^\circ C$ to $+105^\circ C$)	120S-X	-	-	0.5	2	% V_O
Output Ripple and Noise (Across 2 x 0.47 μF Ceramic Cap) See FIG 2. ($I_O = I_{O,max}$, at $T_A = 25^\circ C$)	All	-	-	50	100	mV _{PK-PK}
	120S-X	-	-	75	120	mV _{PK-PK}
	All	-	-	-	30	mV _{RMS}
RMS	120S-X	-	-	-	35	mV _{RMS}
External Load Capacitance	All	-	-	-	2200	μF
	120S-X	-	-	-	220	μF
Output Current	033S-MX	I_o	0.60	-	6.0	A
	050S-X	I_o	0.40	-	4.0	A
	120S-X	I_o	0.16	-	1.67	A
Output Current-limit Inception ($V_o = 90\% V_{o,set}$)	033S-MX	I_o	-	-	8.5	A
	050S-X	I_o	-	-	6.0	A
	120S-X	I_o	-	-	3.0	A
Output Short-circuit Current ($V_o = 250mV$)	All	-	-	-	190	% $I_{o,max}$
Efficiency ($V_I = V_{I,nom}$; $I_{o,max}$; $T_A = 25^\circ C$)	033S-MX	I_o	79	81	-	%
	050S-X	I_o	83	85	-	%
	120S-X	I_o	85	87	-	%
Switching Frequency	All	-	-	400	-	KHz
Turn-On Time ($I_o = I_{o,max}$; V_o within 1% $V_{o,set}$)	All	-	-	70	100	msec



TECHNICAL REFERENCE NOTES (AA20C)

Electrical Specifications *(continued)*

Parameter	Device	Symbol	Min	Typ	Max	Unit
Dynamic Response						
Slew Rate ($V_I = V_{I,nom}$; $T_A = 25^\circ\text{C}$)		$\Delta I_o/\Delta t$		0.1		A/ μsec
Load Change: 50% to 75% of $I_{O,max}$	All	-	-	2	6	% V_o
Peak Deviation Settling Time (to 1% $V_{o,set}$)	All	-	-	250	500	μsec
Load Change: 50% to 25% of $I_{O,max}$	All	-	-	2	6	% V_o
Peak Deviation Settling Time (to 1% $V_{o,set}$)	All	-	-	250	500	μsec
Output Voltage Overshoot ($I_o = I_{O,max}$; $T_A = 25^\circ\text{C}$)	All	-	-	-	5	% V_o

FEATURE SPECIFICATIONS

Parameter	Device	Symbol	Min	Typ	Max	Unit
Remote On/Off Signal Interface ($V_I = 0$ to $V_{I,max}$; Open collector or equivalent compatible ; Signal referenced to $V_I(-)$ terminal.)						
Positive Logic – Suffix “-4” Low Logic – Module Off High Logic – Module On						
Negative Logic – Suffix “-1” Low Logic – Module On High Logic – Module Off						
Module Specifications						
On/Off Current – Logic Low	All	$I_{ON/OFF}$	-	-	1.0	mA
On/Off Voltage :						
Logic Low	All	$V_{ON/OFF}$	-0.7	-	1.2V	V
Logic High ($I_{ON/OFF} = 0$)	All	$V_{ON/OFF}$	-	-	10V	V
Open Collector Switch Specifications						
Leakage Current – Logic High ($V_{on/off} = 10V$)	All	$I_{ON/OFF}$	-	-	50	μA
Output Voltage – Logic Low ($I_{on/off} = 1\text{mA}$)	All	$V_{ON/OFF}$	-	-	1.2	V



TECHNICAL REFERENCE NOTES (AA20C)

FEATURE SPECIFICATION *(continued)*

Parameter	Device	Symbol	Min	Typ	Max	Unit
Output Voltage Adjustment Voltage Adjustment Range	All	-	90	-	100	%V _O
Output Overvoltage Clamp	033S-MX	V _{O,clamp}	3.9	-	5.7	V
	0505-X	V _{O,clamp}	5.9	-	7.0	V
	120S-X	V _{O,clamp}	13.5	-	16.0	V
Undervoltage Lockout Turn-on Point	All	-	-	34.5	35	V
	All	-	30	32.5	-	V
Overtemperature Shutdown	All	-	105	110	120	°C

ISOLATION SPECIFICATIONS

Parameter	Device	Symbol	Min	Typ	Max	Unit
Isolation Capacitance	All	-	-	260	-	pF
Isolation Resistance	All	-	-	1000	-	Mohm

SAFETY APPROVAL

The AA20C family is certified under the following: UL/cUL 1950 (Recognized) and TUV 60950 (Certified).

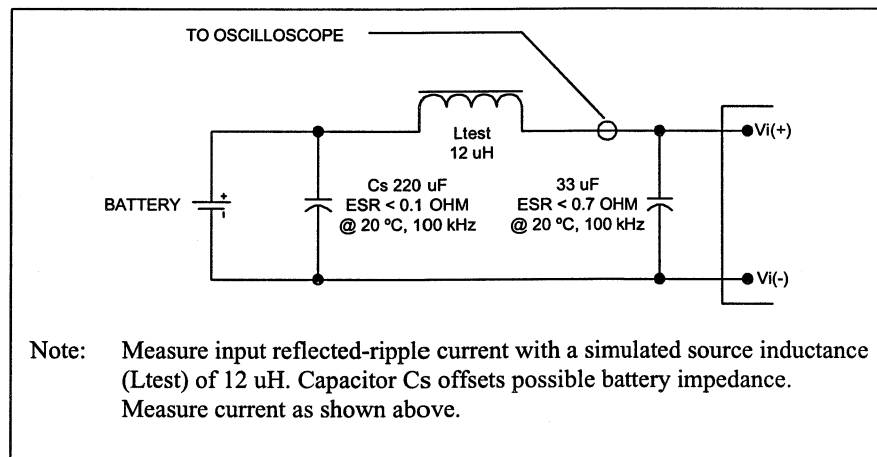

Figure 1. Input Reflected-ripple Test Setup

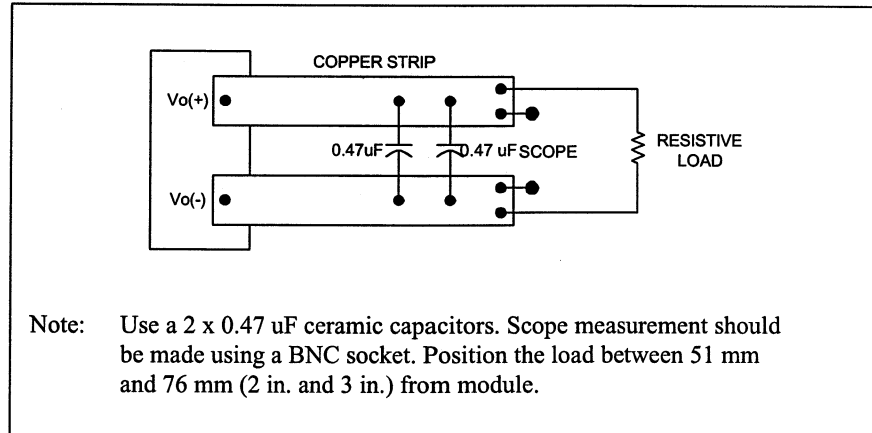

Figure 2. Peak-to-Peak Output Noise Measurement Test Setup



Basic Operation and Features

OUTPUT VOLTAGE ADJUSTMENT OPTION

Output voltage adjustment is accomplished by connecting an external resistor between the Vadj Pin / Trim Pin (Pin 8) and either the +Vout (Pin 6) or -Vout Pins (Pin 7).

With an external resistor between the Vadj Pin and +Vout Pin (Radj-down) the output voltage set point (Vo,adj) can be decreased (see Figure 4). The following equation determines the required external resistor value to obtain an adjusted output voltage:

$$R_{adj_dn} = \frac{A \cdot (V_{adj}C - B \cdot E)}{(A + B) \cdot E - V_{adj}C} - D$$

Where Radj-down is the resistance value and A, B, C, D, and E are defined in Table 1.

With an external resistor, Radj-up between the Vadj Pin / Trim Pin and -Vout Pin the output voltage set point (Vo,adj) increases (see Figure 5). The following equation determines the required external resistor value to obtain an adjusted output voltage:

$$R_{adj_up} = \frac{A \cdot B \cdot E}{V_{adj}C - (A + B) \cdot E} - D$$

Where Radj-up is the resistance value and A, B, C, D, and E are defined in Table 1:

Table 1. Output Adjustment Variables.

Model	A	B	C	D	E
033S	1690	1534	1210	4120	1.24
050S	3400	5880	4640	6810	2.5
120S	3400	2420	1210	6810	2.5

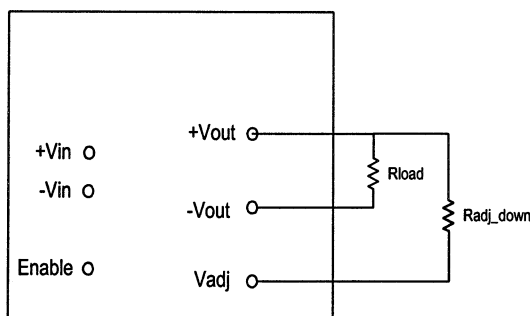

Figure 4. Output Trim Setup to decrease V_O

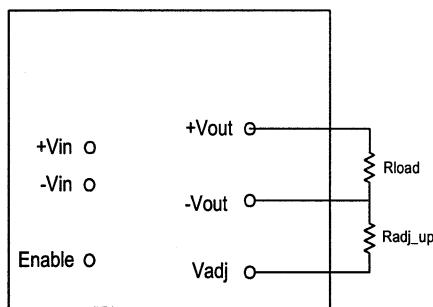

Figure 5. Output Trim Setup to Increase V_O



Basic Operation and Features *(continued)*

OUTPUT ENABLE / REMOTE ON-OFF

Pin 4 is an open collector pin functioned to enable the output voltage of a module. A "-4" suffix option is configured as positive logic whereas a "-1" suffix is configured as negative enable. If there is no suffix in the part number, there is no external pin control to turn On/Off the module.

EFFICIENCY

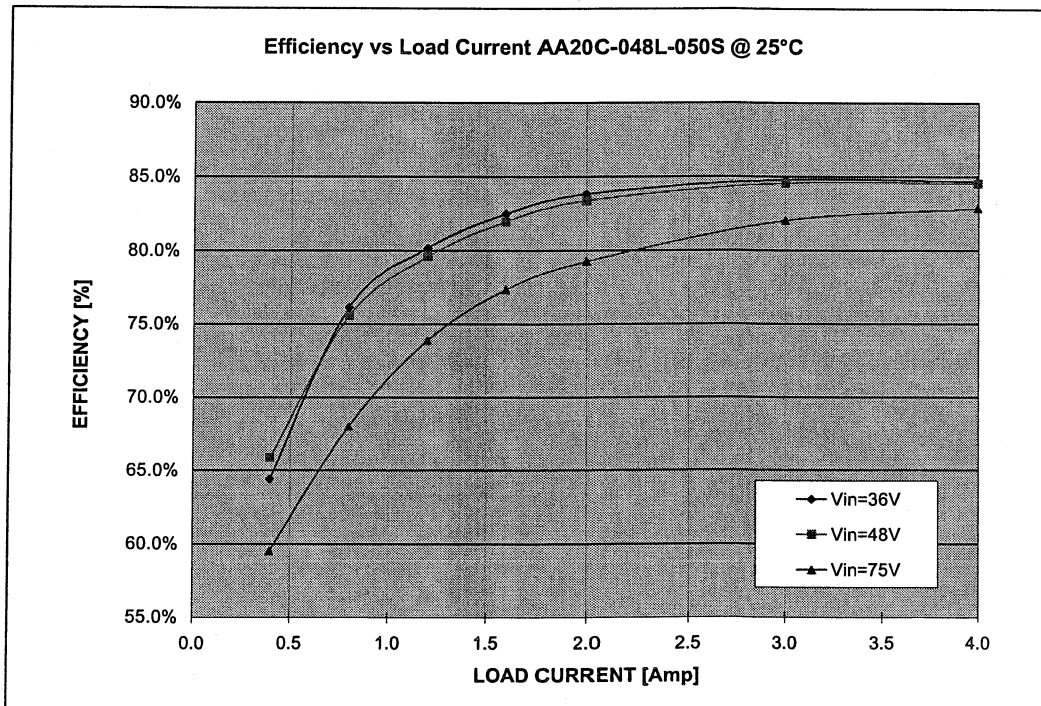

Figure 6. Efficiency Curve for 5V version at Ta = 25° C



AA20C 5V POWER VS TEMPERATURE

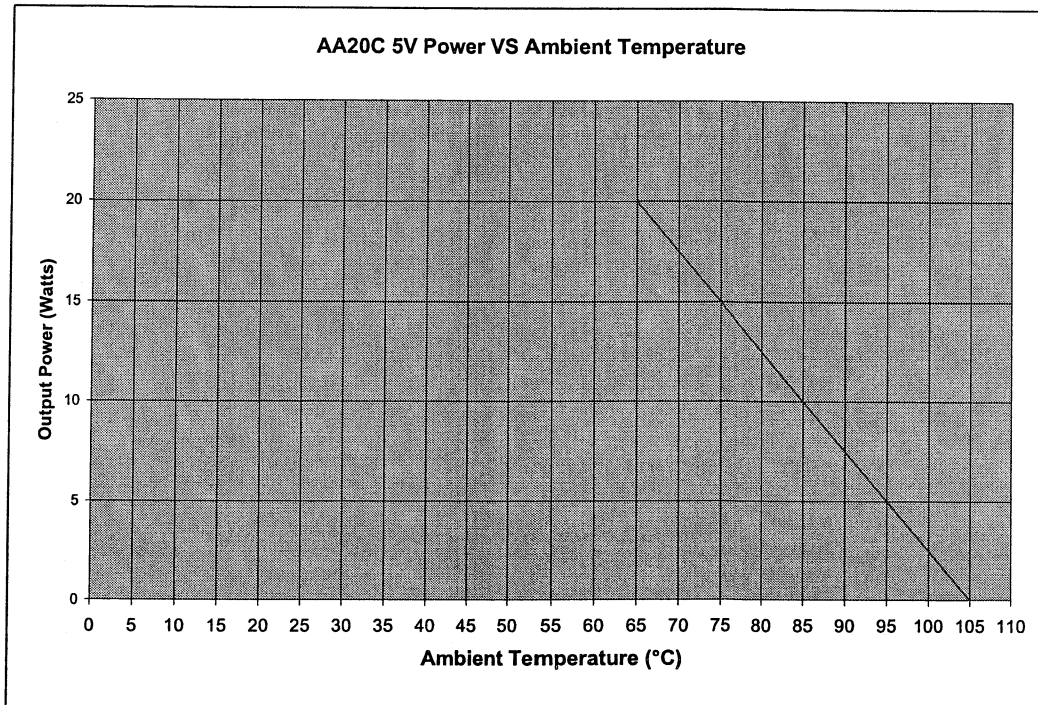

Figure 7. AA20C 5V Power Derating Curve



Mechanical Specification

OUTLINE DRAWING AND MODULE PIN ASSIGNMENT

PIN ASSIGNMENT

- 1 + V IN
- 2 - V IN
- 3 NO PIN
- 4 ENABLE
- 5 NO PIN
- 6 +V OUT
- 7 -V OUT
- 8 TRIM

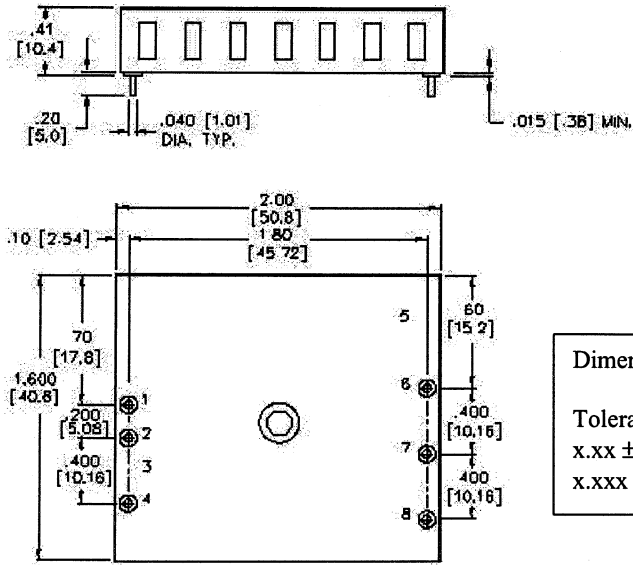

Dimensions: inches [mm]
Tolerances:
x.xx ± 0.02 in [x.x ± 0.5mm]
x.xxx ± 0.010 in [x.xx ± 0.25mm]

BOTTOM VIEW

Figure 8. Mechanical Outline