



Branche Connecteurs Aéromilitaires



FDBA series Normes UTE C 93422 mod. HE 302,
NF L 54130 et / and EN 3646

- *Connecteur aéronautique et ferroviaire / Aeronautic and railway industry connector*
- *Connecteur baïonnette circulaire / Circular bayonet connector*
- *Gain de masse et d'encombrement / Saving in weight and overall dimension*

Présentation	1	<i>Introduction</i>	1
Avantages	2	<i>Advantages</i>	2
Synoptique	3	<i>Synoptic</i>	3
Caractéristiques techniques	4	<i>Technical characteristics</i>	5
Système de référence	6	<i>Part numbering system</i>	6
Détrompage mécanique	6	<i>Keying mechanism</i>	6
Arrangements	7	<i>Arrangements</i>	7
Embases	8	<i>Receptacles</i>	8
Embases hermétiques	10	<i>Hermetic receptacles</i>	10
Fiches	11	<i>Plugs</i>	11
Accouplements	12	<i>Mating and unmating dimensions</i>	12
capuchons	12	<i>Protective covers</i>	12
Accessoires	13	<i>Accessories</i>	13
Contacts et outillages	14-15	<i>Contacts and tools</i>	14-15

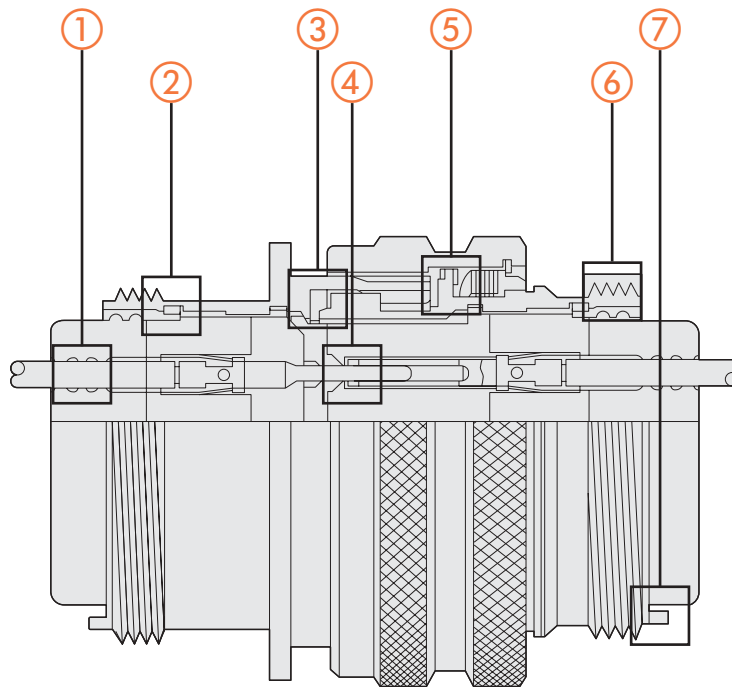

- 1 – Etanchéité garantie sur chaque câble, grâce à plusieurs barrières d'étanchéité.
- 2 – Rétention mécanique de l'isolant par clip.
- 3 – Etanchéité interfaciale garantie par compression de l'isolant et joint périphérique.
- 4 – Etanchéité individuelle des contacts assurée à l'accouplement par compression des cheminées élastomère sur isolant dur.
- 5 – Rondelles anti-friction, permettant à l'effort de verrouillage de rester constant.
- 6 – Etanchéité entre boîtier et isolant garantie par potting.
- 7 – Système anti-rotation par crans sur l'arrière du corps de prise permettant un serrage et blocage efficaces des accessoires.

- 1 – Triple wire sealing.
- 2 – Mechanical retention of the insert by a snap ring.
- 3 – Interfacial seal ensured by compression of insert and static/dynamic seal.
- 4 – Contacts individual sealing at coupling stage by compression of elastomer conical risers on hard insert.
- 5 – Anti-friction washers for constant mating force.
- 6 – Insert to shell sealing with potting.
- 7 – Connector rear part fitted with a teeth anti-rotation system assuming an effective tightening and clamping.

- Verrouillage baïonnettes.
- Connecteur conforme aux normes UTE C 93422 modèles HE 302 et HE 303, NF L 54130, à la spécification BES/SST/ELC/321 Prod., (B.A.C. et Aérospatiale) et AECMA EN 3646.
- Boîtier en alliage d'aluminium anodisé noir ou nickelé. Hermétiques en acier nickelé
- Isolant en élastomère silicone et en résine thermodurcissable.
- Gain de masse (25%) et d'encombrement (23%) par rapport aux connecteurs de la NAS 1599.
- Contacts à sertir de taille 20 et 16.
- Contacts à picot pour circuit imprimé, embase étanche et hermétique.
- Isolant arrière à barrières réduites acceptant les nouveaux câbles utilisés en aéronautique.
- 9 tailles de boîtiers et 24 arrangements disponibles.
- Embases hermétiques avec contacts à souder.
- *Bayonet coupling*
- *Connector meet requirements of UTE C 93422 models HE 302 and HE 303, NF L 54130, specification BES/SST/ELC/321 Prod., (B.A.C. and Aérospatiale) and AECMA EN 3646.*
- *Black anodized or nickel plating aluminium shells. Hermetics in nickel steel.*
- *Silicone elastomere and thermosetting resin insert.*
- *Gain in weight (25%) and overall dimension (23%) compared to NAS 1599 connectors.*
- *Crimping contacts size 20 and 16.*
- *Contacts for printed circuit available in sealed and hermetic shells.*
- *Back silicone insert on each wire to accept the new generation of aeronautic cables.*
- *9 sizes of shells and 24 arrangements available.*
- *Solder contacts hermetic shells.*

Accessoires
Accessories

Fiches
Plugs

Embases
Receptacles

Accessoires
Accessories

A451 Ecrou arrière allégé
Lightened backhell

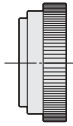

A285 Ecrou arrière
Backhell

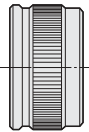

059 Serre câble droit
Straight cable clamp

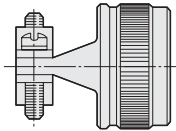

081 Serre câble coude
Elbowed cable clamp

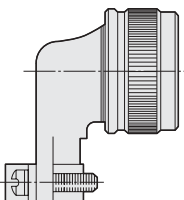

56

Avec couronne de masse
With earth continuity

57

Collerette carrée Fixation 4 vis
4 screw square / Box mounting

50

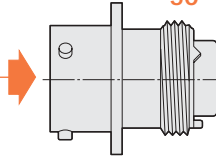

Collerette ronde Fixation écrou
Round nut box Mounting

54

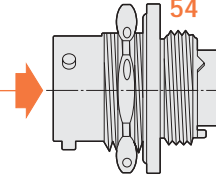

Embases hermétiques
Hermetical receptacles

Collerette carrée Fixation 4 vis
4 screw square Box mounting

50H

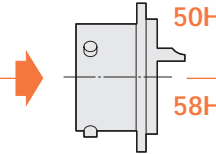

Collerette carrée
Contacts à picot
4 screw square box
Mounting pin contacts

50H A276A

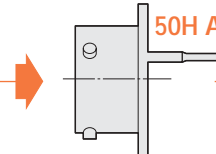

Collerette ronde Fixation écrou
Round nut box Mounting

54H

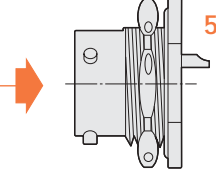

Collerette à souder
Soldered box mounting

53H

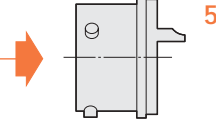

Prise de repos
Dummy receptacle

50PR

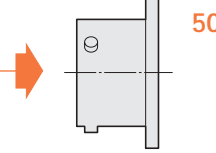

A451 Ecrou arrière allégé
Lightened backhell

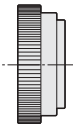

A285 Ecrou arrière
Backhell

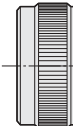

059 Serre câble droit
Straight cable clamp

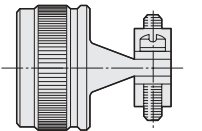

081 Serre câble coude
Elbowed cable clamp

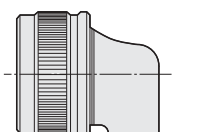

Joint à plat
Flat gasket



Capuchons pour embases
Protective cap for receptacles

DBAC 50

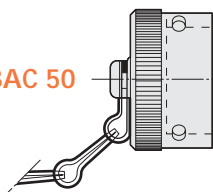

DBAC 50-54

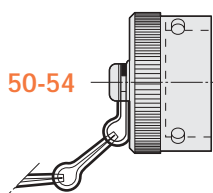

Capuchons pour fiches
Protective cap for plugs

DBAC 56

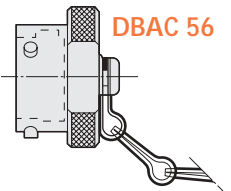

DBAC 56-54

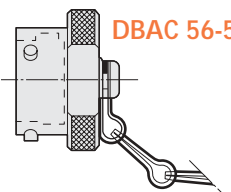

DBAC 56-56

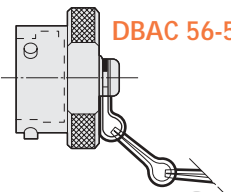

Mécaniques

Boîtier	Matière	Version étanche : Alliage d'aluminium Version hermétique : Acier
	Revêtement	Version étanche : Anodisé noir ou nickelé Version hermétique : Nickelé
Isolant	Matière	Version étanche : Résine thermodurcissable et élastomère silicone Version hermétique : Verre fritté
Résistance aux fluides		(conforme BES/SST/ELC/321/Prod. et MIL C 26482) Oronite M2V, skydrol, kérosène JP2 et JP4, huiles moteurs et fluides hydrauliques
Tenue en pression de l'isolant verre		Version hermétique : 70 bars
Contacts	Matière et revêtement	: Alliage cuivreux - Or sur nickel Version étanche : Type à sertir, montage et démontage par l'arrière du connecteur Version hermétique : Ferro nickel - Or sur nickel - Type à souder
	Rétention	Version étanche : Par clip unitaire à chaque contact intégré dans l'isolant Taille 20 : $9 \pm 0,13$ daN Taille 16 : $11 \pm 0,13$ daN Taille 12 : $11 \pm 0,13$ daN
Étanchéité		(conforme à la norme MIL-C 26482) Fuite \leq à 16 cm ³ /h sous 2,1 bars
Vibrations		Conforme à la norme MIL-STD 202 méthode 204, condition B
Chocs		Version étanche : 100 g 11 millisecondes dans les 3 axes Version hermétique : 50 g dans les 3 axes
Endurance		500 cycles complets de verrouillages et déverrouillages
Température d'utilisation		- 55° C à + 200° C
Chocs thermiques		10 cycles de - 55° C à + 200° C
Herméticité		Sous une dépression de 1×10^{-6} torr fuite inférieure à 2,8mm ³ /h

Electriques

Tension de tenue		Au niveau de la mer – service 1 : 1500V eff. 50 Hz – service 2 : 2300V eff. 50 Hz
Tension d'utilisation		Service 1 : 500 V eff. 50 Hz Service 2 : 750 V eff. 50 Hz
Résistance d'isolement		Version étanche : \geq à 5000 M Ω à 25° C et 60% HR Version hermétique : \geq à 5000 M Ω à 20° C et 65% HR
Intensité maximale des contacts		Version étanche : Taille 20 : 7,5 A max. Taille 16 : 13 A max. Taille 12 : 23 A max. Version hermétique : Taille 20 : 5 A max. Taille 16 : 10 A max. Taille 12 : 17 A max.
Résistance de contact		Version étanche : Taille 20 : 3 m Ω sous intensité max. Taille 16 : 2 m Ω sous intensité max. Taille 12 : 1,5 m Ω sous intensité max. Version hermétique : Taille 20 : 21 m Ω sous intensité max. Taille 16 : 14 m Ω sous intensité max. Taille 12 : 11 m Ω sous intensité max.
Section câble admissible		Version étanche : Taille 20 : 0,21 à 0,60 mm ² Taille 16 : 0,60 à 1,34 mm ² Taille 12 : 1,91 à 3,18 mm ² Version hermétique : Taille 20 : 0,21 à 0,93 mm ² Taille 16 : 0,60 à 1,91 mm ² Taille 12 : 1,91 à 3,18 mm ²
Diamètre sur gaine		Version étanche : Taille 20 : 0,71 à 2,11 mm Taille 16 : 1,20 à 2,62 mm Taille 12 : 1,93 à 4,01 mm

Mechanical

Shell	Material	Sealing version : Aluminium alloy Hermetical version : Steel
	Plating	Sealing version : Black anodize or nickel plating Hermetical version : Nickel
Insert	Material	Sealing version : Thermosetting resin, silicone elastomere Hermetical version : Sintered glass insert
Fluid resistance		(in accordance with BES/SST/ELC/321/Prod. and MIL C 26482) Oronite M2V, skydrol, JP2 and JP4 kerosene, engine oils and hydraulics fluids
Pressure resistance		Hermetical version : 70 bars
Contacts	Material and plating	: Copper alloy – Gold over nickel Sealing version : Crimp type, rear release Hermetical version : Ferrous – Gold over nickel – Solder type
	Retention	Sealing version : By clip on each contact integreat Size 20 : $9_{-0}^{+0,13}$ daN Size 16 : $11_{-0}^{+0,13}$ daN Size 12 : $11_{-0}^{+0,13}$ daN
Sealing		(in accordance with MIL C 26482) Maximum leakage ≤ 16 cm ³ /h under 2,1 bars pressure
Vibrations		In accordance with MIL–STD 202 method 204, condition B
Physical shocks		Sealing version : 100 g 11 ms in the 3 axes Hermetical version : 50 g in the 3 axes
Durability		500 full coupling and uncoupling cycles
Service temperature		– 55° C to + 200° C
Thermal shocks		10 cycles from – 55° C to + 200° C
Air leakage		Less than to 2,8 mm ³ /h under 1×10^{-6} torr vacuum

Electrical

Withstanding voltage		At sea level : service 1 : 1500 V eff 50Hz service 2 : 2300 V eff. 50 Hz
Service voltage		Service 1 : 500 V eff. 50 Hz Service 2 : 750 V eff. 50 Hz
Insulation resistance	Sealing version :	\geq to 5000 M Ω to 25° C and 60% HR
	Hermetical version :	\geq to 5000 M Ω to 20° C and 65% HR
Contacts maximum current	Sealing version :	Size 20 : 7,5 A max. Size 16 : 13 A max. Size 12 : 23 A max.
	Hermetical version :	Size 20 : 5 A max. Size 16 : 10 A max. Size 12 : 17 A max.
Insulation resistance	Sealing version :	Size 20 : 3 m Ω under max. intensity Size 16 : 2 m Ω under max. intensity Size 12 : 1,5 m Ω under max. intensity
	Hermetical version :	Size 20 : 21 m Ω under max. intensity Size 16 : 14 m Ω under max. intensity Size 12 : 11 m Ω under max. intensity
Allowed wires section	Sealing version :	Size 20 : 0,21 to 0,60 mm ² Size 16 : 0,60 to 1,34 mm ² Size 12 : 1,91 to 3,18 mm ²
	Hermetical version :	Size 20 : 0,21 to 0,93 mm ² Size 16 : 0,60 to 1,91 mm ² Size 12 : 1,91 to 3,18 mm ²
Diameter over insulation sheath		Size 20 : 0,71 to 2,11 mm Size 16 : 1,20 to 2,62 mm Size 12 : 1,93 to 4,01 mm

Type de boîtier

- 50 : Embase collerette carrée
- 53 : Embase collerette à souder, uniquement hermétique
- 54 : Embase collerette ronde
- 56 : Fiche
- 57 : Fiche avec couronne de masse
- 58 : Embase collerette carrée large, uniquement hermétique
- * : Version inox, nous consulter

Shell type

- 50 : Square flange receptacle
- 53 : Solder receptacle, hermetic only
- 54 : Single hole mounting receptacle
- 56 : Plug
- 57 : Plug with RFI fingers
- 58 : Large square flange, hermetic only
- * : stainless steel, consult us

Taille du boîtier
Shell size
8-10-12-14-16-18-20-22-24

Modifications spéciales

- Cadmié vert olive : 023
- Serre-câble droit : 059
- Serre-câble coudé : 081
- Connecteur livré sans contact : 090
- Contact taille 20 conforme à la norme ASNE : A246
- Arrangements hybrides gauge 20 plus 16, conformes à la norme ASNE : B246
- Connecteur livré avec écrou arrière : A 285
- Écrou arrière allégé : A 451

Genre du contact

- Contact mâle : P
 - Contact femelle : S
- Contact type**
- Male contact : P
 - Female contact : S

- Connecteur version nickelé : A 499
 - Embase hermétique collerette carrée avec contacts à picot : A 276 A
- Special Modifications**
- Olive drab cadmium : 023
 - Straight cable clamp : 059
 - Elbowed cable clamp : 081
 - Delivery without contact : 090
 - Size 20 contact in accordance with ASNE : A246
 - Hybrid arrangement gauge 20 and 16, in accordance with ASNE : B246
 - Supplied with backshell : A 285
 - Lightened backshell : A 451
 - Nickel version connector : A 499
 - Hermetical square flange receptacle with special contacts for printed circuit : A 276 A

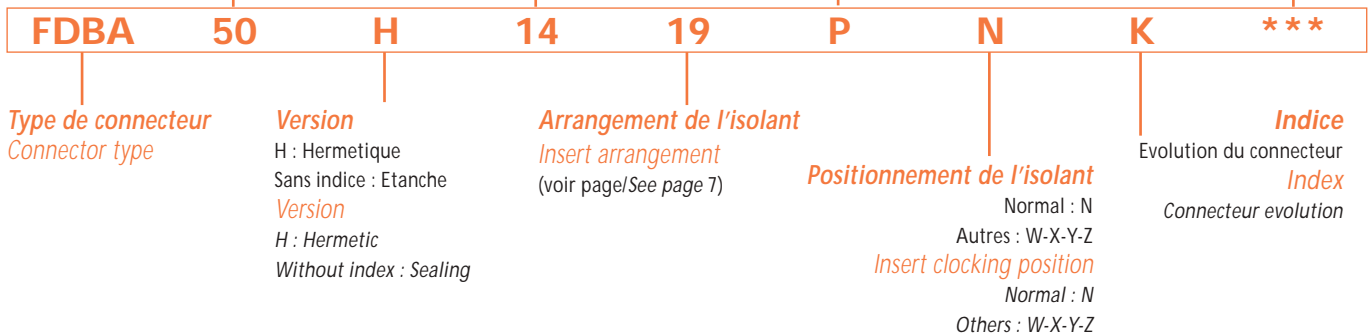

Détrompage mécanique / Keying mechanism

Le positionnement est normal lorsque l'axe vertical de l'isolant est confondu avec l'axe de la clavette du boîtier (repé-
rage N).

Un détrompage peut-être effectué entre deux connecteurs de même disposition par un décalage angulaire de l'un des
isolants dans son boîtier. Cette rotation de l'isolant s'effectue dans le sens des aiguilles d'une montre pour les dispositions
mâles et dans le sens inverse pour les dispositions femelles. Les décalages angulaires déterminés (voir tableau ci-contre)
donnent les positions W - X - Y - ou Z.

*Clocking position is normal when the insert vertical axis is intermingled with the shell keyway axis. An unkeying can be performed
between 2 connectors of same layout by angular displacement of one of the inserts in its shell. This insert rotation is made in the
clockwise for pin layouts and in the counter clockwise for socket layouts. Angular displacements on the hereafter table give clocking
positions W - X - Y - or Z (see table opposite).*

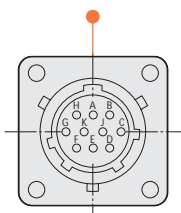

Positionnement normal
Normal clocking position

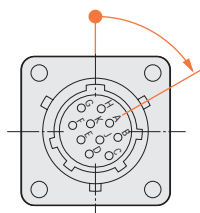

Positionnement Y
Normal clocking Y

Arrangements Arrangements	Positionnement en degrés Clocking position in degrees				Nombre de contacts Number of contacts		
	W	X	Y	Z	Tailles / Sizes		
					20	16	12
8-3A / 8-98	60	-	-	-	3	-	-
8-33	90	-	-	-	3	-	-
10-6	90	-	-	-	6	-	-
12-3	-	-	180	-	-	3	-
12-8	90	112	203	292	8	-	-
12-10	60	155	270	295	10	-	-
14-4	45	-	-	-	-	-	4
14-5	40	92	184	273	-	5	-
14-12	43	90	-	-	8	4	-
14-15	17	110	155	234	14	1	-
14-19	30	165	315	-	19	-	-
16-8	54	152	180	331	-	8	-
16-21	-	-	-	-	16	5	-
16-26	60	-	275	338	26	-	-
18-11	62	119	241	340	-	11	-
18-32	85	138	222	265	32	-	-
20-16	238	318	333	347	-	16	-
20-39	63	144	252	333	37	2	-
20-41	45	126	225	-	41	-	-
22-21	16	135	175	349	-	21	-
22-12	-	-	-	-	0-	-	12
22-41	39	-	-	-	27	14	-
22-55	30	142	226	314	55	-	-
24-61	90	180	270	324	61	-	-

Exemple de décalage angulaire de l'isolant, vue face avant mâle
Exemple of insert angular displacement, male front face view

Vu face avant isolant mâle / Male insert viewed from front face.



Disposition 08-3A/08-98 *
3 contacts taille/size 20



Disposition 08-33 *
3 contacts taille/size 20



Disposition 10-06 *
6 contacts taille/size 20



Disposition 12-03 *
3 contacts taille/size 16



Disposition 12-08
8 contacts taille/size 20



Disposition 12-10 *
10 contacts taille/size 20

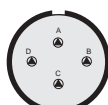

Disposition 14-4
4 contacts taille/size 12

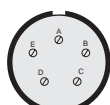

Disposition 14-5
5 contacts taille/size 16

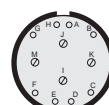

Disposition 14-12 *
8 contacts taille/size 20
4 contacts taille/size 16

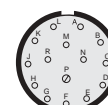

Disposition 14-15 *
14 contacts taille/size 20
1 contacts taille/size 16

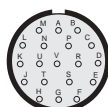

Disposition 14-19 *
19 contacts taille/size 20

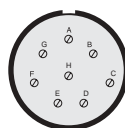

Disposition 16-08
8 contacts taille/size 16

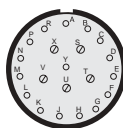

Disposition 16-21
16 contacts taille/size 20
5 contacts taille/size 16

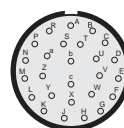

Disposition 16-26 *
26 contacts taille/size 20

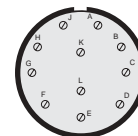

Disposition 18-11
11 contacts taille/size 16

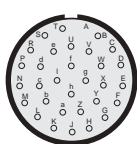

Disposition 18-32 *
32 contacts taille/size 20

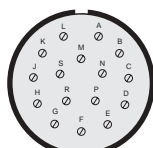

Disposition 20-16
16 contacts taille/size 16

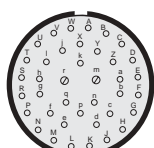

Disposition 20-39
37 contacts taille/size 20
2 contacts taille/size 16

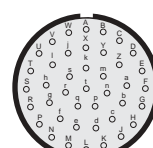

Disposition 20-41 *
41 contacts taille/size 20

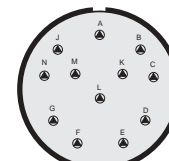

Disposition 22-12
12 contacts taille/size 12

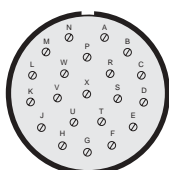

Disposition 22-21
21 contacts taille/size 16

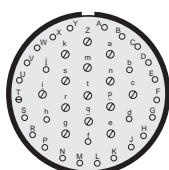

Disposition 22-41 *
27 contacts taille/size 20
14 contacts taille/size 16

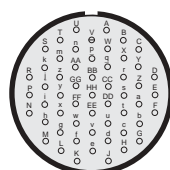

Disposition 22-55 *
55 contacts taille/size 20

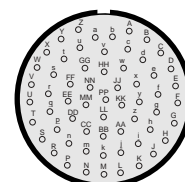

Disposition 24-61
61 contacts taille/size 20

* Disponibles en hermétique. Available in hermetic version.

Collerette carrée / Square flange

Version étanche
Sealing version

- Sans écrou arrière / Less backshell **FDBA 50**

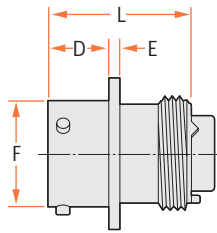

4 trous/holes $\varnothing 3,15 \pm 0,15$
tailles/sizes 8 à/to 22
4 trous/holes $\varnothing 3,73 \pm 0,15$
tailles/sizes 24

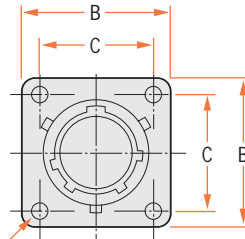

Taille Size	L max.
08	25,50
10	25,50
12	25,50
14	25,50
16	25,50
18	25,50
20	27,95
22	27,95
24	27,95

- Avec écrou arrière / With backshell **FDBA 50-**-A285**

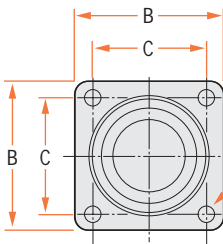

4 trous/holes $\varnothing 3,15 \pm 0,15$
tailles/sizes 8 à/to 22
4 trous/holes $\varnothing 3,73 \pm 0,15$
tailles/sizes 24

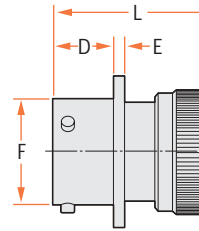

Taille Size	L max.
08	31,45
10	31,45
12	31,45
14	31,45
16	31,45
18	31,45
20	33,85
22	33,85
24	33,85

- Avec serre-cable droit / With straight cable clamp **FDBA 50-**-059**

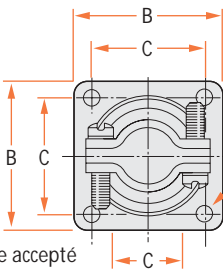

4 trous/holes $\varnothing 3,15 \pm 0,15$
tailles/sizes 8 à/to 22
4 trous/holes $\varnothing 3,73 \pm 0,15$
tailles/sizes 24

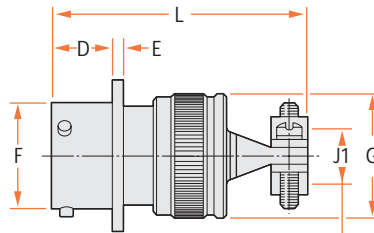

\varnothing max. câble accepté
 \varnothing allowed cable

\varnothing max. brides serrées
 \varnothing tightened cable

Taille Size	J1 max.	J max.	L max.
08	5,15	6,80	40,40
10	7,25	7,95	40,40
12	10,55	12,75	40,40
14	12,05	14,60	46,40
16	15,85	17,80	46,40
18	17,95	19,80	46,40
20	21,05	23,00	48,85
22	24,25	26,10	48,85
24	27,45	28,80	48,85

- Avec serre-cable coudé / With elbowed cable clamp **FDBA 50-**-081**

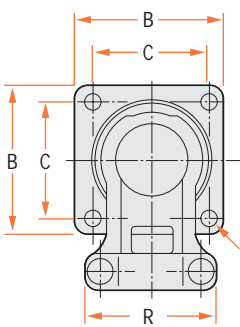

4 trous/holes $\varnothing 3,15 \pm 0,15$
Tailles/sizes 8 à/to 22
4 trous/holes $\varnothing 3,73 \pm 0,15$
tailles/sizes 24

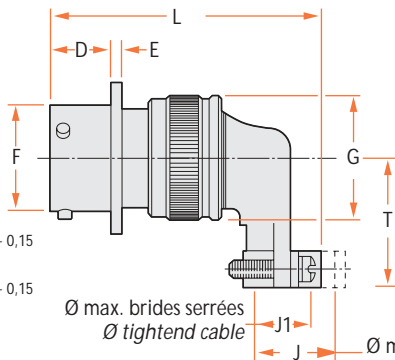

\varnothing max. brides serrées
 \varnothing tightend cable

\varnothing max. câble accept

Taille Size	J1 max.	J max.	L max.	R max.	T max.
08	5,15	6,80	43,80	17,40	20,70
10	7,25	7,95	46,15	20,20	22,00
12	10,55	12,75	49,60	23,60	23,80
14	12,05	14,60	51,85	25,50	25,30
16	15,85	17,80	55,25	29,70	26,80
18	17,90	19,80	58,70	32,60	28,30
20	21,05	23,00	64,50	36,00	29,90
22	24,25	26,10	67,60	39,20	31,60
24	27,40	28,80	70,70	42,80	33,20

- Mode de fixation / Mounting styles

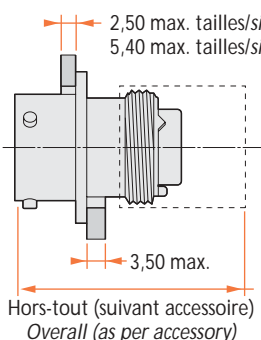

Hors-tout (suivant accessoire)
Overall (as per accessory)

Perçage panneau
Panel cutout

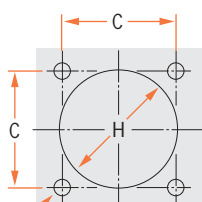

4 trous/holes $\varnothing 3,15 \pm 0,15$
tailles/sizes 8 à/to 22
4 trous/holes $\varnothing 3,73 \pm 0,15$
tailles/sizes 24

Taille Size	B max.	C $\pm 0,1$	D $\pm 0,15$	E max.	F max.	G max.	H -0 $+0,2$
08	21,00	15,08	11,13	1,45	12,03	15,65	16,05
10	24,25	18,26	11,13	1,45	15,01	18,65	19,00
12	26,60	20,62	11,13	1,45	19,07	21,80	22,25
14	29,00	23,02	11,13	1,45	22,24	25,00	25,40
16	31,30	24,58	11,13	1,45	25,42	28,25	28,60
18	33,70	26,98	11,13	1,45	28,60	30,95	31,75
20	36,85	29,36	14,85	2,25	31,77	34,15	34,90
22	39,95	31,76	14,85	2,25	34,94	37,30	38,10
24	43,15	34,92	15,70	2,25	38,12	40,45	41,30

Collerette ronde / Single hole mounting

Version étanche
Sealing version

- Sans écrou arrière / Less backshell **FDBA 54**

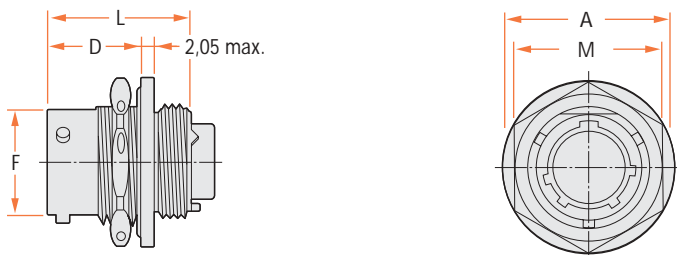

Taille Size	L max.
8	25,50
10	25,50
12	25,50
14	25,50
16	25,50
18	25,50
20	27,95
22	27,95
24	27,95

- Avec écrou arrière / With backshell **FDBA 54-**-A285**

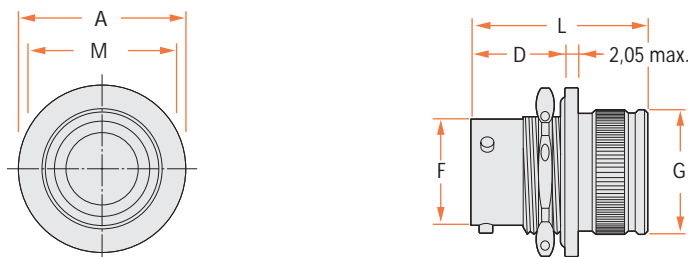

Taille Size	L max.
8	31,45
10	31,45
12	31,45
14	31,45
16	31,45
18	31,45
20	33,85
22	33,85
24	33,85

- Avec serre-cable droit / With straight cable clamp **FDBA 54-**-059**

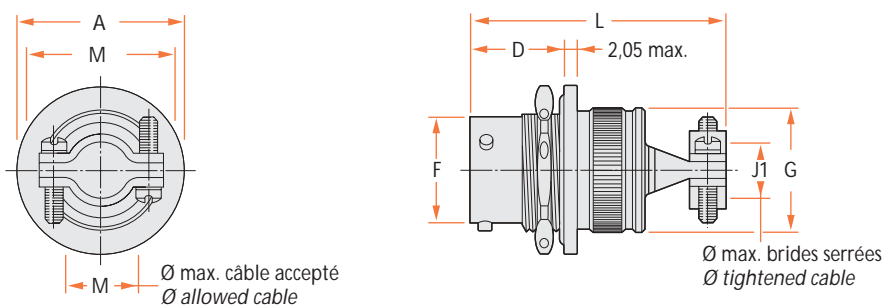

Taille Size	J1 max.	J max.	L max.
8	5,15	6,80	40,40
10	7,25	7,95	40,40
12	10,55	12,75	40,40
14	12,05	14,60	46,40
16	15,85	17,80	46,40
18	17,95	19,80	46,40
20	21,05	23,00	48,85
22	24,25	26,10	48,85
24	27,45	28,80	48,85

- Avec serre-cable coudé / With elbowed cable clamp **FDBA 54-**-081**

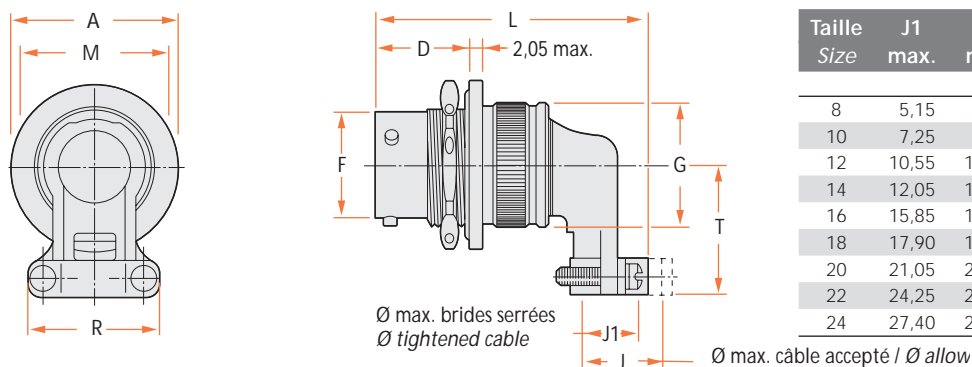

Taille Size	J1 max.	J min.	L max.	R max.	T max.
8	5,15	6,80	43,85	17,40	20,70
10	7,25	7,95	46,20	20,20	22,00
12	10,55	12,75	49,65	23,60	23,80
14	12,05	14,60	51,90	25,50	25,30
16	15,85	17,80	55,30	29,70	26,80
18	17,90	19,80	58,75	32,60	28,30
20	21,05	23,00	64,50	36,00	29,90
22	24,25	26,10	67,60	39,20	31,60
24	27,40	28,80	70,70	42,80	33,20

- Mode de fixation / Mounting styles

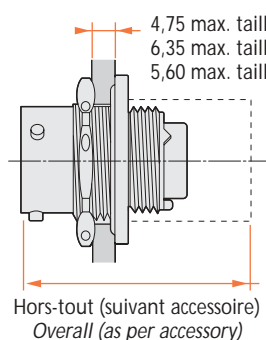

Perçage panneau
Panel cutout

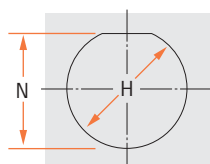

Taille Size	A max.	D ± 0,15	F max.	G max.	H +0 -0,2	M max.	N +0 -0,2
8	23,30	16,70	12,03	15,65	14,70	19,20	13,85
10	26,60	16,70	15,01	18,65	17,85	22,37	17,05
12	30,40	16,70	19,07	21,80	22,60	27,12	21,15
14	33,80	16,70	22,24	25,00	25,75	30,30	24,30
16	37,00	16,70	25,42	28,25	28,95	33,47	27,45
18	40,15	16,70	28,60	30,95	32,10	36,67	30,65
20	45,20	19,10	31,77	34,15	35,30	39,82	33,80
22	48,35	19,10	34,94	37,30	38,45	43,02	37,00
24	51,55	19,10	38,12	40,45	41,65	46,17	40,15

Hors-tout (suivant accessoire)
Overall (as per accessory)

Collerette carrée / Square flange

Mode de fixation
Mounting styles

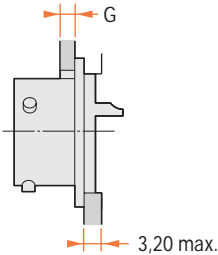

Taille Size	B max.	B1 max.	C ± 0,1	C1 ± 0,1	D ± 0,15	D1 max.	F max.	G max.	H +0 -0,2	L max.	P max. Tailles / Sizes 20 16
8	21,00	26,50	15,08	18,10	12,65	1,55	12,03	2,50	16,05	-	6,85 8,95
10	24,25	29,10	18,26	20,62	12,65	1,55	15,01	2,50	19,00	13,75	6,85 8,95
12	26,60	32,25	20,62	23,82	12,62	1,55	19,07	2,50	22,25	13,75	6,85 8,95
14	29,00	34,65	23,02	26,18	12,65	1,55	22,24	2,50	25,40	13,75	6,85 8,95
16	31,30	37,00	24,58	28,57	12,65	1,55	25,42	2,50	28,60	13,75	6,85 8,95
18	33,70	39,05	26,98	30,55	12,65	1,55	28,60	2,50	31,75	13,75	6,85 8,95
20	36,85	43,00	29,36	32,94	14,09	2,25	31,77	5,40	34,90	15,35	7,10 9,20
22	39,95	44,95	31,76	34,92	14,09	2,25	34,94	5,40	38,10	-	7,10 9,20
24	43,15	48,15	34,92	38,10	14,93	2,25	38,12	5,40	41,30	-	6,25 8,35

Pour circuits imprimés
For printed circuit boards

Percage panneau
Panel cutout

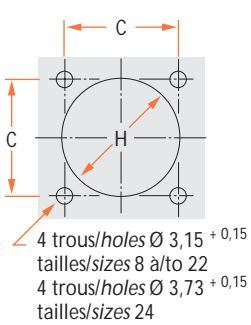

FDBA 50H

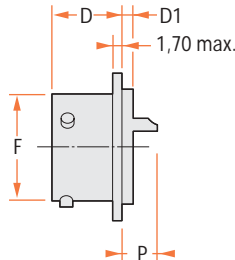

FDBA 50H-**-A276A

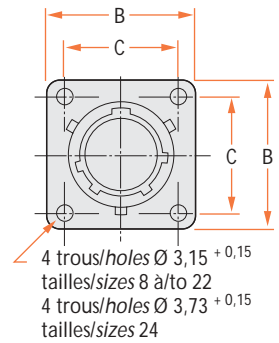
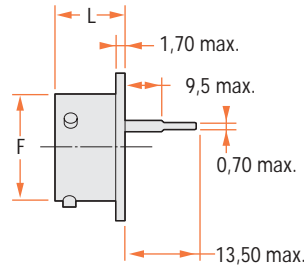

FDBA 58H

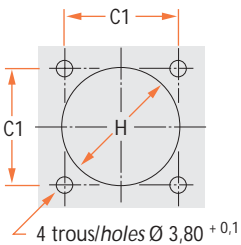

FDBA 58H

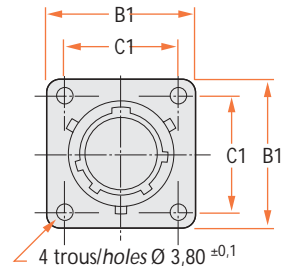
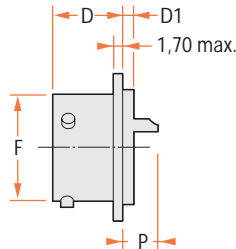

Collerette ronde / Single hole mounting

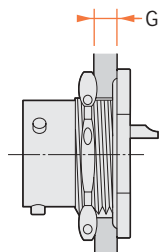

Mode de fixation
Mounting styles

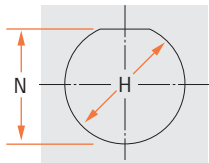

Percage panneau
Panel cutout

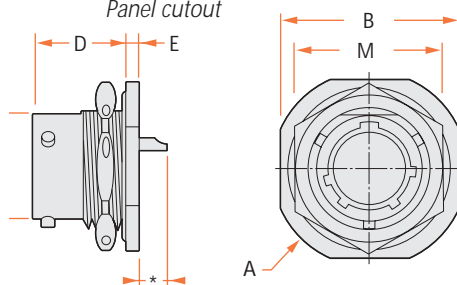

Taille Size	A max.	B max.	D ± 0,15	E max.	F max.	G max.	H +0 -0,2	M max.	N +0 -0,2
8	27,30	24,00	17,81	2,50	12,03	3,17	14,70	19,20	13,85
10	30,50	27,20	17,81	2,50	15,01	3,17	17,85	22,37	17,05
12	35,30	32,00	17,81	2,50	19,07	3,17	22,60	27,12	21,15
14	38,40	35,10	17,81	2,50	22,24	3,17	25,75	30,30	24,30
16	41,60	38,30	17,81	2,50	25,42	3,17	28,95	33,47	27,45
18	44,80	41,50	17,81	2,50	28,60	3,17	32,10	36,67	30,65
20	49,60	46,20	22,58	3,30	31,77	6,35	35,30	39,82	33,80
22	52,70	49,40	22,58	3,30	34,94	6,35	38,45	43,02	37,00
24	55,90	52,60	23,67	3,30	38,12	6,35	41,65	46,17	40,15

Les # 20 sont en retrait dans le boîtier

Collerette à souder / Solder flange

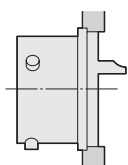

Mode de fixation
Mounting styles

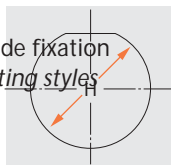

Perçage panneau
Panel cutout

Taille Size	A max.	D ±0,5	D1 max.	F max.	G max.	H	P max. Tailles/Sizes 20 16	
	8	16,10	11,50	2,60	12,03	14,35	14,75	7,95
10	19,25	11,50	2,60	15,01	17,15	17,55	7,95	10,00
12	21,65	11,50	2,60	19,07	19,90	20,30	7,95	10,00
14	24,85	11,50	2,60	22,24	23,10	23,50	7,95	10,00
16	28,00	11,50	2,60	25,42	26,25	26,65	7,95	10,00
18	31,15	11,50	2,60	28,60	29,45	29,85	7,95	10,00
20	33,55	13,11	3,35	31,77	31,80	32,20	8,20	10,30
22	36,70	13,11	3,35	34,94	35,00	35,40	8,20	10,30
24	39,90	13,95	3,35	38,12	38,15	38,55	7,35	9,45

Fiches / Plugs

FDBA

- Sans écrou arrière / Less backshell
FDBA 56 / FDBA 57-**-A499

Version étanche
Sealing version

En version 57, équipée de la couronne de masse RFI, commander impérativement le connecteur dans le système de référence avec la modification A499 (connecteur nickelé).

Shell type 57 with RFI fingers must be ordered in accordance with part numbering system with the modification A499 (nickel version connector).

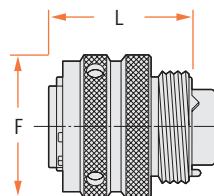

Taille Size	F max.	L max.
08	11,75	25,55
10	21,05	25,55
12	24,60	25,55
14	28,05	25,55
16	31,10	25,55
18	34,40	25,55
20	37,65	27,10
22	40,90	27,10
24	44,10	27,10

- Avec écrou arrière / With backshell
FDBA 56-**-A285 / FDBA 57-**-A5787

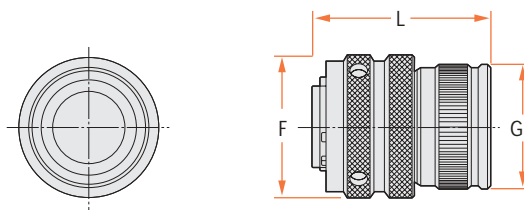

Taille Size	F max.	G max.	L max.
08	17,75	15,65	31,45
10	21,05	18,65	31,45
12	24,60	21,80	31,45
14	28,05	25,00	31,45
16	31,10	28,25	31,45
18	34,40	30,95	31,45
20	37,65	34,15	33,00
22	40,90	37,30	33,00
24	44,10	40,45	33,00

- Avec serre-cable droit / With straight cable clamp
FDBA 56-**-059 / FDBA 57-**-A5559

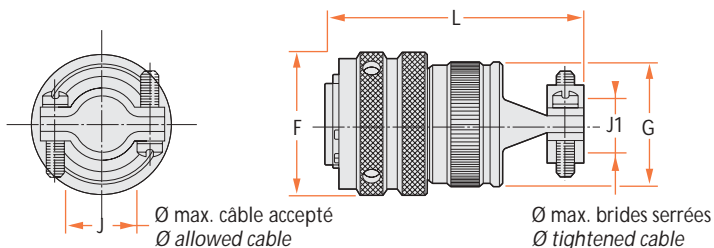

Taille Size	F max.	G max.	J1 max.	J mini.	L max.
08	17,75	15,65	5,15	6,80	40,40
10	21,05	18,65	7,25	7,95	40,40
12	24,60	21,80	10,55	12,75	40,40
14	28,05	25,00	12,05	14,60	46,40
16	31,10	28,25	15,85	17,80	46,40
18	34,40	30,95	17,95	19,80	46,40
20	37,65	34,15	21,05	23,00	47,95
22	40,90	37,30	24,25	26,10	47,95
24	44,10	40,45	27,45	28,80	47,95

- Avec serre-cable coudé / With elbowed cable clamp
FDBA 56-**-081 / FDBA 57-**-A5560

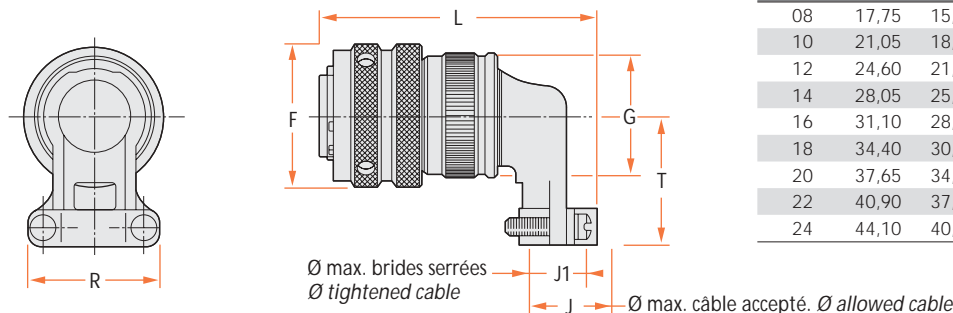

Taille Size	F max.	G max.	J1 max.	J mini.	L max.	R max.	T max.
08	17,75	15,65	5,15	6,80	43,85	17,40	20,70
10	21,05	18,65	7,25	7,95	46,20	20,20	22,00
12	24,60	21,80	10,55	12,75	49,65	23,60	23,80
14	28,05	25,00	12,05	14,60	51,90	25,50	25,30
16	31,10	28,25	15,85	17,80	55,30	29,70	26,80
18	34,40	30,95	17,90	19,80	58,75	32,60	28,30
20	37,65	34,15	21,05	23,00	63,65	36,00	29,90
22	40,90	37,30	24,25	26,10	66,75	39,20	31,60
24	44,10	40,45	27,40	28,80	69,85	42,80	33,20

Collerette carrée Square flange

Collerette ronde Single hole mounting

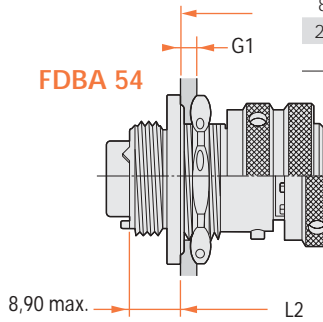
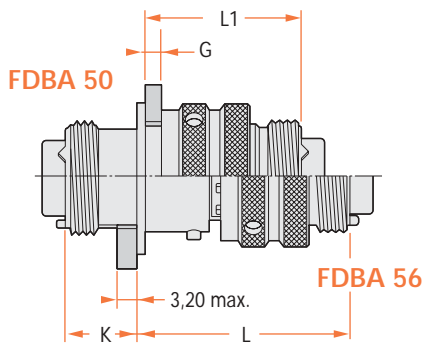

Taille Size	K	L	L1	L2	L3	G	G1
8 à 18	13,30	38,25	28,65	42,45	34,20	2,50	4,75
20 - 22	11,15	44,30	32,30	46,35	36,55	5,40	6,35
24	10,30	45,15	33,15	46,35	36,55	5,40	5,60

Capuchons / Protective covers

Pour embases / For receptacles

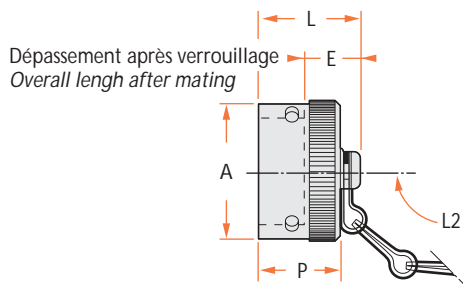

DBAC 50

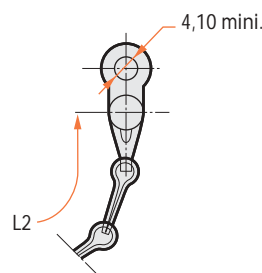

Fixation sur collerette carrée
For receptacle mounting on
square flange receptable

DBAC 50-54

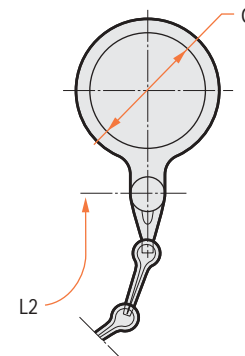

Fixation sur embase
collerette ronde
For plug mounting on single
hole mounting

Pour fiches / For plugs

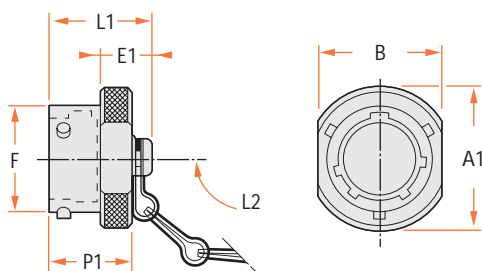

DBAC 56

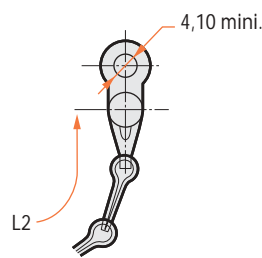

Fixation sur accessoire arrière
For plug attached to cable clamp

DBAC 56-54

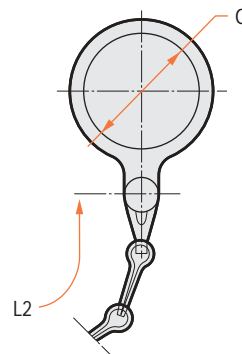

Fixation sur embase
collerette ronde
For plug mounting on single
hole mounting

DBAC 56-58

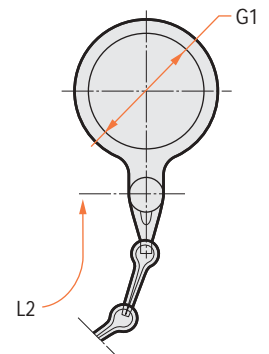

Fixation sur fiche
For plug attached on plug

Nota : La Mod A190, ajoutée à la fin de la référence, vous permet d'obtenir un fil nylon à la place de la chaînette
Mod A190, add at the end of the reference, permit to replace the chain by a nylon wire.

Taille Size	A	A1	B	E	E1	F	G	G1	L	L1	L2	P	P1
8	16,60	18,30	16,10	10,15	9,60	12,03	14,60	12,45	17,85	18,65	79,00	14,20	14,40
10	19,70	21,50	18,10	10,15	9,60	15,01	17,70	15,70	17,85	18,65	79,00	14,20	14,40
12	24,60	25,40	22,10	10,15	9,60	19,07	22,50	18,85	17,85	18,65	95,00	14,20	14,40
14	27,80	28,60	24,10	10,15	9,60	22,24	25,70	22,10	17,85	18,65	95,00	14,20	14,40
16	30,90	31,80	27,10	10,15	9,60	25,42	28,90	25,50	17,85	18,65	95,00	14,20	14,40
18	34,10	34,90	30,10	10,15	9,60	28,60	32,00	27,35	17,85	18,65	95,00	14,20	14,40
20	37,30	38,10	33,10	10,15	9,60	31,77	35,20	30,40	17,85	20,25	111,00	14,20	16,00
22	40,50	41,30	36,10	10,15	9,60	34,94	38,40	33,30	17,85	20,25	111,00	14,20	16,00
24	44,10	44,50	41,10	10,30	10,45	38,12	41,60	36,80	18,85	21,10	111,00	15,20	16,80

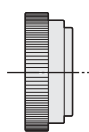

• Ecrou arrière allégé
Lightened backshell

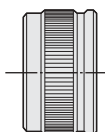

• Ecrou arrière standard
Standard backshell

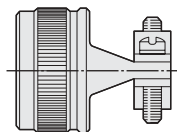

• Serre-cable droit
Straight cable clamp

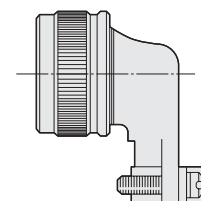

• Serre-câble coudé
Elbowed cable clamp

Taille Size	Nouvelle réf. New ref.		Ancienne réf. Former ref.		Nouvelle réf. New ref.		Ancienne réf. Former ref.		Nouvelle réf. New ref.		Ancienne réf. Former ref.	
	8	004-0003-08	EP 38 002-08	006-0909-08	38 002-08	006-0910-08	38 003-08	006-0908-08	38 001-08			
10	004-0003-10	EP 38 002-10	006-0909-10	38 002-10	006-0910-10	38 003-10	006-0908-10	38 001-10				
12	004-0003-12	EP 38 002-12	006-0909-12	38 002-12	006-0910-12	38 003-12	006-0908-12	38 001-12				
14	004-0003-14	EP 38 002-14	006-0909-14	38 002-14	006-0910-14	38 003-14	006-0908-14	38 001-14				
16	004-0003-16	EP 38 002-16	006-0909-16	38 002-16	006-0910-16	38 003-16	006-0908-16	38 001-16				
18	004-0003-18	EP 38 002-18	006-0909-18	38 002-18	006-0910-18	38 003-18	006-0908-18	38 001-18				
20	004-0003-20	EP 38 002-20	006-0909-20	38 002-20	006-0910-20	38 003-20	006-0908-20	38 001-20				
22	004-0003-22	EP 38 002-22	006-0909-22	38 002-22	006-0910-22	38 003-22	006-0908-22	38 001-22				
24	004-0003-24	EP 38 002-24	006-0909-24	38 002-24	006-0910-24	38 003-24	006-0908-24	38 001-24				

Prise de repos pour fiches / Dummy receptacles for plugs

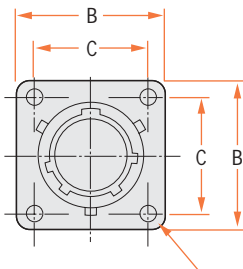
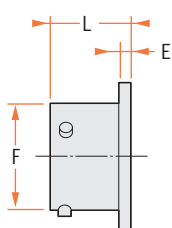

4 trous/holes Ø 3,15 +0,15 tailles/sizes 8 à/to 22

Taille Size	référence reference	B max.	C ±0,1	E max.	F max.	L max.
8	DBA50PR08	21,00	15,08	1,95	12,03	14,70
10	DBA50PR10	24,20	18,26	1,95	15,01	14,70
12	DBA50PR12	26,55	20,62	1,95	19,07	14,70
14	DBA50PR14	28,95	23,02	1,95	22,24	14,70
16	DBA50PR16	31,30	24,58	1,95	25,42	14,70
18	DBA50PR18	33,70	26,98	1,95	28,60	14,70
20	DBA50PR20	36,85	29,36	2,55	31,77	17,20
22	DBA50PR22	39,95	31,76	2,55	34,94	17,20
24	DBA50PR24	43,15	34,92	2,55	38,12	17,20

Joint plat / Panel seal

■ Pour embase collerette carrée / For square flange receptacle

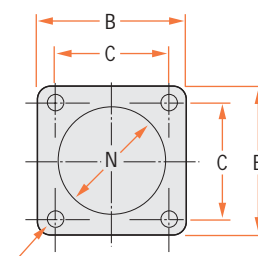
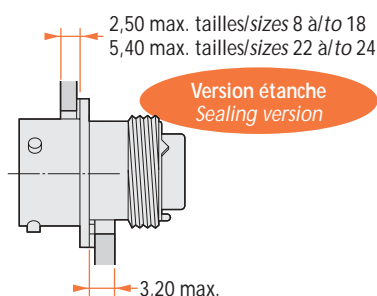
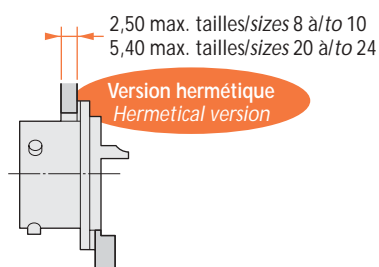

4 trous/holes Ø 3,30 +0,15 tailles/sizes 8 à/to 22
4 trous/holes Ø 4,30 +0,15 tailles/sizes 24

Nota : * Pour commander le joint plat spécial kérosène, ajouter 395 à la référence du joint
* To order the kerosene special flat gasket, add 395 to the gasket reference

Taille Size	Joint avant collerette Front flange mounting			Joint arrière collerette Rear flange mounting								
	Pour version étanche et hermétique Hermetical version sealing version			Pour version hermétique For hermetical version			Pour version étanche For sealing version					
	Nouvelle réf. New ref.	Ancienne réf. Former ref.	H max.	B max.	C ±0,1	H max.	Nouvelle réf. New ref.	Ancienne réf. Former ref.	H max.	Nouvelle réf. New ref.	Ancienne réf. Former ref.	Taille Size
8	108-0003-08-B756	Fg-4080-0372-1-2	12,50	21,10	15,10	14,90	108-0005-08-B756	Fg-4080-0576-1-2	13,20	108-0001-08-B756	Fg-4080-0615-1-2	8
10	108-0003-10-B756	Fg-4100-0372-1-2	15,40	24,30	18,30	17,50	108-0005-10-B756	Fg-4100-0576-1-2	16,40	108-0001-10-B756	Fg-4100-0615-1-2	10
12	108-0001-12-B756	Fg-4120-0372-1-2	19,50	26,70	20,60	20,30	108-0005-12-B756	Fg-4120-0576-1-2	19,50	108-0001-12-B756	Fg-4120-0615-1-2	12
14	108-0001-14-B756	Fg-4140-0372-1-2	22,70	29,10	23,00	23,50	108-0005-14-B756	Fg-4140-0576-1-2	22,70	108-0001-14-B756	Fg-4140-0615-1-2	14
16	108-0001-16-B756	Fg-4160-0372-1-2	25,90	31,30	24,60	26,70	108-0005-16-B756	Fg-4160-0576-1-2	25,90	108-0001-16-B756	Fg-4160-0615-1-2	16
18	108-0003-18-B756	Fg-4180-0372-1-2	29,10	33,70	27,00	29,90	108-0005-18-B756	Fg-4180-0576-1-2	27,50	108-0001-18-B756	Fg-4180-0615-1-2	18
20	108-0003-20-B756	Fg-4200-0372-1-2	32,30	36,90	29,40	32,30	108-0003-20-B756	Fg-4200-0372-1-2	30,60	108-0001-20-B756	Fg-4200-0617-1-2	20
22	108-0003-22-B756	Fg-4220-0372-1-2	35,40	40,10	31,75	35,40	108-0003-22-B756	Fg-4220-0372-1-2	33,50	108-0001-22-B756	Fg-4220-0616-1-2	22
24	108-0003-24-B756	Fg-4240-0372-1-2	38,60	43,30	34,90	38,60	108-0003-24-B756	Fg-4240-0372-1-2	37,00	108-0001-24-B756	Fg-4240-0615-1-2	24

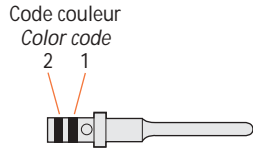

Contact mâle / Male contact

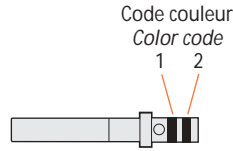

Contact femelle / Female contact

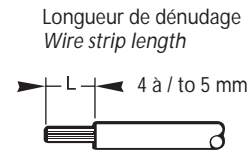

Contacts Contacts					Câbles Cables			
Référence commerciale Commercial Ref	Genre Type	Taille AWG wire	Observations Remarks	Code couleur Color code		Section en mm ² Section in mm ²	Gauge AWG wire	Ø sur gaine Ø over sheath
				1	2			
006-0937-20 A*	P	20	-	rouge	rouge	0,21 à / to 0,60	20 à / to 24	0,85 à / to 2,10
006-0912-20 A*	S	20	-	red	red			
006-0972-20 A	P	20	contact à fût réduit	rouge	blanc	0,055 à / to 0,15	26 à/to 30	0,85 à / to 2,10
006-0973-20 A	S	20	reduced bucket contact	red	white			
006-0044-20 A**	P	20	contact à fût agrandi	rouge	violet	0,21 à / to 0,93	18 à / to 22	0,85 à / to 2,10
006-0055-20 A**	S	20	enlarged bucket contact	red	purple			
006-0982-20	P	20	contact chromel	repère Ch		0,21 à / to 0,60	20 à / to 24	0,71 à / to 2,10
006-0985-20	S	20	chromel contact	mark Ch				
025-0404-20	P	20	contact chromel	repère Ch		0,38 à / to 0,93	18 à / to 22	0,71 à / to 2,10
025-0405-20	S	20	chromel contact	mark Ch				
006-0983-20	P	20	contact alumel	repère Al		0,21 à / to 0,60	20 à / to 24	0,71 à / to 2,10
006-0984-20	S	20	alumel contact	mark Al				
025-0402-20	P	20	contact alumel	repère Al		0,38 à / to 0,93	18 à / to 22	0,71 à / to 2,10
025-0403-20	S	20	alumel contact	mark Al				
006-1060-20	P	20	contact constantan	repère Co		0,21 à / to 0,60	20 à / to 24	0,71 à / to 2,10
006-1062-20	S	20	constantan contact	mark Co				
025-0406-20	P	20	contact constantan	repère Co		0,38 à / to 0,93	18 à / to 22	0,71 à / to 2,10
025-0407-20	S	20	constantan contact	mark Co				
006-0937-16 A*	P	16	-	bleu	bleu	0,60 à / to 1,34	16 à / to 20	1,28 à / to 2,62
006-0912-16 A*	S	16	-	blue	blue			
006-1102-16 A	P	16	contact à fût agrandi	bleu	orange	0,93 à / to 1,91	14 à / to 18	1,28 à / to 2,62
006-1104-16 A	S	16	enlarged bucket contact	blue	orange			
025-0870-16 A	P	16	contact à fût réduit	bleu	noir	0,055 à / to 0,15	26 à / to 30	1,28 à / to 2,62
025-0871-16 A	S	16	reduced bucket contact	blue	black			
006-1168-16 A	P	16	contact à fût réduit	bleu	rouge	-	20 à / to 24	1,28 à / to 2,62
006-1169-16 A	S	16	reduced bucket contact	blue	red			
006-0937-12 A*	P	12	-	jaune	jaune	1,91 à / to 3,18	12 à / to 14	1,93 à / to 4,01
006-0912-12 A*	S	12	-	yellow	yellow			
006-1157-12 A	P	12	contact à fût réduit	jaune	bleu	0,60 à / to 1,34	16 à / to 20	1,93 à / to 4,01
006-1159-12 A	S	12	reduced bucket contact	yellow	blue			

* Contacts standards livrés avec le connecteur
Standard contacts supplied with connector

** Contacts livrés avec les mods A246 et B246 (conformes à la norme ASNE 052/053/054)
contacts supplied with mod A246 and B246 (in accordance with ASNE 052/053/054)

Face arrière
du connecteur

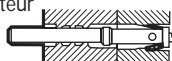

Connector rear face

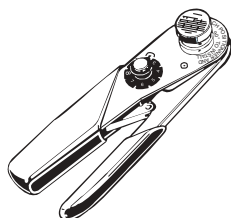

Obturateur <i>Sealing plug</i>		Pince à sertir <i>Crimping tool</i>		Outil de montage et de démontage <i>Insertion and extraction tool</i>		Outil de démontage des contacts non câblés <i>Extraction tool non wired contacts</i>	
Référence <i>Reference</i>	Couleur <i>Color</i>	Référence <i>Reference</i>	Référence de la tourelle <i>Turret reference</i>	Contacts câblés <i>Wired contacts</i>	Référence <i>Reference</i>	Embout de rechange <i>Alternate end</i>	
006-0893-20	rouge <i>red</i>	057-0461-11	057-0462-21	M 15570-20	057-0481-60	057-0502-60	
006-0893-20	rouge <i>red</i>	057-0463-11	057-0464-21	M 15570-20	057-0481-60	057-0502-60	
006-0893-20	rouge <i>red</i>	057-0461-11	057-0462-21	M 155570-20	057-0481-60	057-0502-60	
006-0893-20	rouge <i>red</i>	057-0461-11	057-0462-21	M 15570-20	057-0481-60	057-0502-60	
006-0893-20	rouge <i>red</i>	057-0461-11	057-0462-21	M 15570-20	057-0481-60	057-0502-60	
006-0893-20	rouge <i>red</i>	057-0461-11	057-0462-21	M 15570-20	057-0481-60	057-0502-60	
006-0893-20	rouge <i>red</i>	057-0461-11	057-0462-21	M 15570-20	057-0481-60	057-0502-60	
006-0893-20	rouge <i>red</i>	057-0461-11	057-0462-21	M 15570-20	057-0481-60	057-0502-60	
006-0893-20	rouge <i>red</i>	057-0461-11	057-0462-21	M 15570-20	057-0481-60	057-0502-060	
006-0893-20	rouge <i>red</i>	057-0461-11	057-0462-21	M 15570-20	057-0481-60	057-0502-60	
006-0893-16	bleu <i>blue</i>	057-0461-11	057-0462-21	M 15570-16	057-0481-60	057-0499-60	
006-0893-16	bleu <i>blue</i>	057-0461-11	057-0462-21	M 15570-16	057-0481-60	057-0499-60	
006-0893-16	bleu <i>blue</i>	057-0463-12	057-0464-32	M 15570-16	057-0481-60	057-0499-60	
006-0893-16	bleu <i>blue</i>	057-0461-11	057-0462-21	M 15570-16	057-0481-60	057-0499-60	
006-0892-12	jaune <i>yellow</i>	057-0461-11	057-0462-21	M 15570-12	057-0481-60	057-0500-60	
006-0892-12	jaune <i>yellow</i>	057-0461-11	057-0462-21	M 15570-12	057-0481-60	057-0500-60	



Connecteurs Electriques Deutsch

17, rue Lavoisier z.i. n° 2 B.P. 117 27091 EVREUX CEDEX 9 (FRANCE)

Tél.: +33 (0)2 32 23 57 00 - Fax : +33 (0)2 32 23 58 00

E-mail : ced@compagnie-deutsch.com

Web : www.compagnie-deutsch.com

Réf.: CC 689-41 D Edition Mai 2002