



Features

- 184-Pin Registered 8-Byte Dual In-Line Memory Module
- 32M/64Mx72 and x64 Double Data Rate (DDR) SDRAM DIMM (32M x 8 SDRAMs)
- Performance:

		PC200		PC266B		Units
DIMM $\overline{\text{CAS}}$ Latency		3	3.5	3	3.5	
f_{CK}	Clock Frequency	100	125	125	133	MHz
t_{CK}	Clock Cycle	10	8.0	8.0	7.5	ns
f_{DQ}	DQ Burst Frequency	200	250	250	266	MHz

- Intended for 100MHz and 133MHz applications
- Inputs and outputs are SSTL-2 compatible
- $V_{\text{DD}} = 2.5\text{Volt} \pm 0.2$, $V_{\text{DDQ}} = 2.5\text{Volt} \pm 0.2$
- Single Pulsed $\overline{\text{RAS}}$ interface
- SDRAMs have four internal banks for concurrent operation
- Module has one or two physical banks depending on configuration
- Serial Presence Detect

- Bi-directional data strobe with one clock cycle preamble and one-half clock post-amble
- Differential clock inputs
- Data is read or written on both clock edges
- Address and control signals are fully synchronous to positive clock edge
- Programmable Operation:
 - DIMM $\overline{\text{CAS}}$ Latency: 3, 3.5
 - Burst Type: Sequential or Interleave
 - Burst Length: 2, 4, 8
 - Operation: Burst Read and Write
- Auto Refresh (CBR) and Self Refresh Modes
- Automatic and controlled precharge commands
- Power Down Mode
- 13/10/2 Addressing (row/column/bank)
- 7.8 μs Max. Average Periodic Refresh Interval
- Card size: 5.25" x 0.157" x 1.70"
- Gold contacts
- SDRAMs in 66-pin TSOP-II Package

Description

This Registered 184-Pin Double Data Rate (DDR) Synchronous DRAM Dual In-Line Memory Module (DIMM) can be organized as both a one- and two-bank high-speed memory array. The 32Mx64/72 is a single-bank DIMM that uses nine (x72) or eight (x64) 32Mx8 DDR SDRAMs in 400 mil TSOP packages. The 64Mx64/72 is a two-bank DIMM that uses 18 (x72) or 16 (x64) 32Mx8 SDRAMs in 400 mil TSOP packages. The DIMM achieves high-speed data transfer rates of up to 266MHz.

The DIMM is intended for use in applications operating from 100MHz to 133MHz clock speeds with data rates of 200 to 266 MHz. All control and address signals are re-driven through registers to the DDR SDRAM devices. The control and address input signals are latched in the register on one rising clock edge and sent to the SDRAM devices on the following rising clock edge.

A phase-locked loop (PLL) on the DIMM is used to re-drive the differential clock signals to both the DDR SDRAM devices and the registers, thus minimizing system clock loading. Clock enable(s)

(CKE0 and/or CKE1) control all devices on the DIMM.

Prior to any access operation, the device $\overline{\text{CAS}}$ latency and burst type/length/operation type must be programmed into the DIMM by address inputs A0-A12 using the mode register set cycle. The DIMM $\overline{\text{CAS}}$ latency exceeds the SDRAM device spec by one clock due to the address and control signals being clocked to the SDRAM devices.

These DIMMs are manufactured using raw cards developed for broad industry use by IBM as 'reference designs'. The use of these common design files will minimize electrical variation between suppliers.

The DIMM uses serial presence detects implemented via a serial EEPROM using the two-pin IIC protocol. The first 128 bytes of serial PD data are programmed and locked during module assembly. The last 128 bytes are available to the customer.

All IBM 184 DDR SDRAM DIMMs provide a high-performance, flexible 8-byte interface in a 5.25" long space-saving footprint.

Card Outline

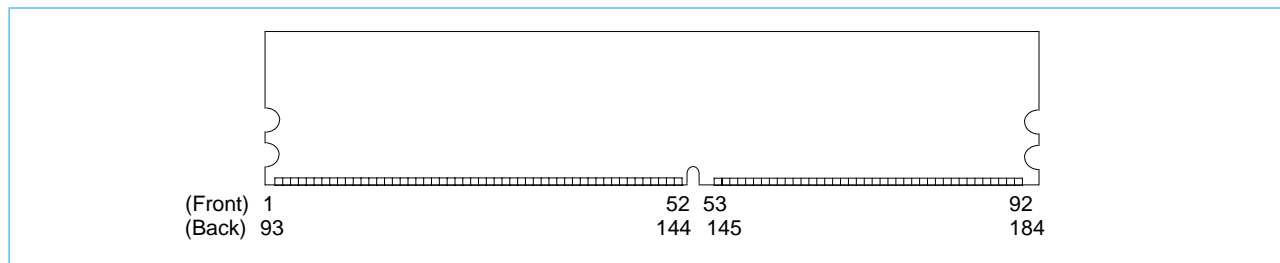

Pin Description

CK0, $\overline{\text{CK0}}$	Differential Clock Inputs	CB0 - CB7	Check Bit Data Input/Output
CKE0,CKE1	Clock Enables		
$\overline{\text{RAS}}$	Row Address Strobe	DM0 - DM8	Data Input Mask
$\overline{\text{CAS}}$	Column Address Strobe	DQS0-DQS8	Bidirectional data strobes
$\overline{\text{WE}}$	Write Enable	V_{DD}	Power (2.5V)
$\overline{\text{S0}}, \overline{\text{S1}}$	Chip Selects	V_{DDQ}	Supply voltage for DQs (2.5V)
A0 - A9, A11, A12	Address Inputs	V_{SS}	Ground
A10/AP	Address Input/Autoprecharge	NC	No Connect
BA0, BA1	SDRAM Bank Address Inputs	SCL	Serial Presence Detect Clock Input
$\overline{\text{RESET}}$	Reset pin	SDA	Serial Presence Detect Data Input/Output
V_{REF}	Ref. Voltage for SSTL_2 inputs	SA0-SA2	Serial Presence Detect Address Inputs
DQ0 - DQ63	Data Input/Output	V_{DDSPD}	Serial EEPROM positive power supply (2.5 V)



IBM16M64644HGA
IBM16M64734HGA

IBM16M32644HGA
IBM16M32734HGA

Preliminary

32/64Mx64/72 1 or 2 Bank Registered DDR SDRAM Module

184-Pin DDR SDRAM DIMM Pin Assignments

Front Side (left side 1 - 52, right side 53 - 92)			Back Side (left side 93 -144, right side 145 -184)			Front Side (left side 1 - 52, right side 53 - 92)			Back Side (left side 93 -144, right side 145 -184)		
Pin #	x64 Non-Parity	x72 ECC	Pin #	x64 Non-Parity	x72 ECC	Pin #	x64 Non-Parity	x72 ECC	Pin #	x64 Non-Parity	x72 ECC
1	VREF	VREF	93	VSS	VSS	48	A0	A0	140	NC	DM8
2	DQ0	DQ0	94	DQ4	DQ4	49	NC	CB2	141	A10	A10
3	VSS	VSS	95	DQ5	DQ5	50	VSS	VSS	142	NC	CB6
4	DQ1	DQ1	96	VDDQ	VDDQ	51	NC	CB3	143	VDDQ	VDDQ
5	DQS0	DQS0	97	DM0	DM0	52	BA1	BA1	144	NC	CB7
6	DQ2	DQ2	98	DQ6	DQ6	KEY			KEY		
7	VDD	VDD	99	DQ7	DQ7	53	DQ32	DQ32	145	VSS	VSS
8	DQ3	DQ3	100	VSS	VSS	54	VDDQ	VDDQ	146	DQ36	DQ36
9	NC	NC	101	NC	NC	55	DQ33	DQ33	147	DQ37	DQ37
10	RESET	RESET	102	NC	NC	56	DQS4	DQS4	148	VDD	VDD
11	VSS	VSS	103	NC	NC	57	DQ34	DQ34	149	DM4	DM4
12	DQ8	DQ8	104	VDDQ	VDDQ	58	VSS	VSS	150	DQ38	DQ38
13	DQ9	DQ9	105	DQ12	DQ12	59	BA0	BA0	151	DQ39	DQ39
14	DQS1	DQS1	106	DQ13	DQ13	60	DQ35	DQ35	152	VSS	VSS
15	VDDQ	VDDQ	107	DM1	DM1	61	DQ40	DQ40	153	DQ44	DQ44
16	NC	NC	108	VDD	VDD	62	VDDQ	VDDQ	154	RAS	RAS
17	NC	NC	109	DQ14	DQ14	63	WE	WE	155	DQ45	DQ45
18	VSS	VSS	110	DQ15	DQ15	64	DQ41	DQ41	156	VDDQ	VDDQ
19	DQ10	DQ10	111	CKE1	CKE1	65	CAS	CAS	157	S0	S0
20	DQ11	DQ11	112	VDDQ	VDDQ	66	VSS	VSS	158	S1	S1
21	CKE0	CKE0	113	BA2	BA2	67	DQS5	DQS5	159	DM5	DM5
22	VDDQ	VDDQ	114	DQ20	DQ20	68	DQ42	DQ42	160	VSS	VSS
23	DQ16	DQ16	115	A12	A12	69	DQ43	DQ43	161	DQ46	DQ46
24	DQ17	DQ17	116	VSS	VSS	70	VDD	VDD	162	DQ47	DQ47
25	DQS2	DQS2	117	DQ21	DQ21	71	NC	NC	163	NC	NC
26	VSS	VSS	118	A11	A11	72	DQ48	DQ48	164	VDDQ	VDDQ
27	A9	A9	119	DM2	DM2	73	DQ49	DQ49	165	DQ52	DQ52
28	DQ18	DQ18	120	VDD	VDD	74	VSS	VSS	166	DQ53	DQ53
29	A7	A7	121	DQ22	DQ22	75	NC	NC	167	NC	NC
30	VDDQ	VDDQ	122	A8	A8	76	NC	NC	168	VDD	VDD
31	DQ19	DQ19	123	DQ23	DQ23	77	VDDQ	VDDQ	169	DM6	DM6
32	A5	A5	124	VSS	VSS	78	DQS6	DQS6	170	DQ54	DQ54
33	DQ24	DQ24	125	A6	A6	79	DQ50	DQ50	171	DQ55	DQ55
34	VSS	VSS	126	DQ28	DQ28	80	DQ51	DQ51	172	VDDQ	VDDQ
35	DQ25	DQ25	127	DQ29	DQ29	81	VSS	VSS	173	NC	NC
36	DQS3	DQS3	128	VDDQ	VDDQ	82	VDDID	VDDID	174	DQ60	DQ60
37	A4	A4	129	DM3	DM3	83	DQ56	DQ56	175	DQ61	DQ61
38	VDD	VDD	130	A3	A3	84	DQ57	DQ57	176	VSS	VSS
39	DQ26	DQ26	131	DQ30	DQ30	85	VDD	VDD	177	DM7	DM7
40	DQ27	DQ27	132	VSS	VSS	86	DQS7	DQS7	178	DQ62	DQ62
41	A2	A2	133	DQ31	DQ31	87	DQ58	DQ58	179	DQ63	DQ63
42	VSS	VSS	134	NC	CB4	88	DQ59	DQ59	180	VDDQ	VDDQ
43	A1	A1	135	NC	CB5	89	VSS	VSS	181	SA0	SA0
44	NC	CB0	136	VDDQ	VDDQ	90	NC	NC	182	SA1	SA1
45	NC	CB1	137	CK0	CK0	91	SDA	SDA	183	SA2	SA2
46	VDD	VDD	138	CK0	CK0	92	SCL	SCL	184	VDDSPD	VDDSPD
47	NC	DQS8	139	VSS	VSS						

NC = No Connect; NU = Not Useable; DU = Do Not Use



Ordering Information

Part Number	Organization	Speed	SDRAM CAS Latency	Leads	Dimension	Power V _{DD} /V _{DDQ}
IBM16M32644HGA - 10HT	32Mx64	PC200	2	Gold	5.25" x 1.7" x 0.167"	2.5 V/2.5 V
IBM16M32644HGA - 8ET		PC266B	2.5			
IBM16M32734HGA - 10HT	32Mx72	PC200	2			
IBM16M32734HGA - 8ET		PC266B	2.5			
IBM16M64644HGA - 10HT	64Mx64	PC200	2			
IBM16M64644HGA - 8ET		PC266B	2.5			
IBM16M64734HGA - 10HT	64Mx72	PC200	2			
IBM16M64734HGA - 8ET		PC266B	2.5			

x72 ECC DDR Registered SDRAM DIMM Block Diagram (1 Bank, x8 DDR SDRAMs)

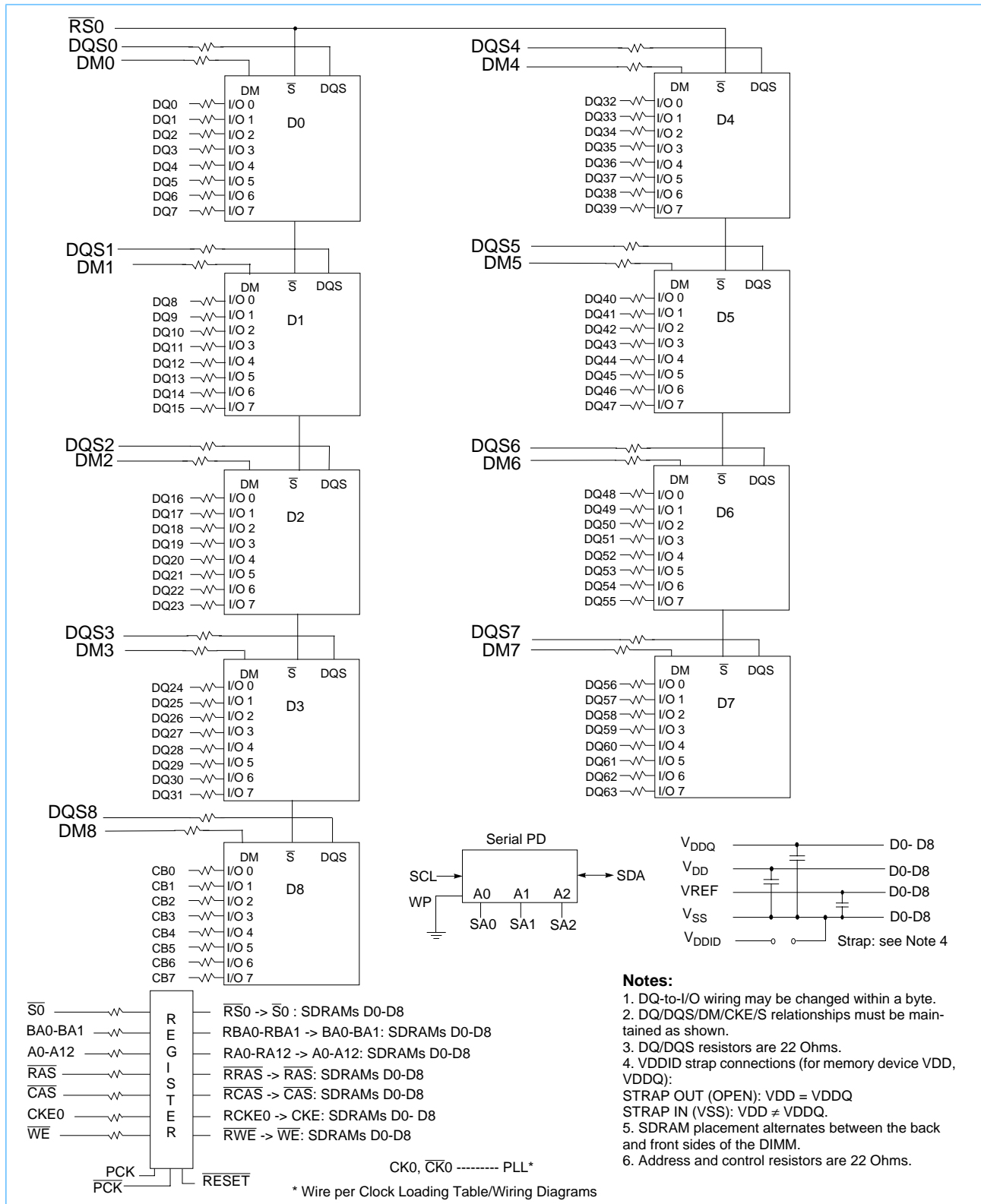

x72 ECC DDR Registered SDRAM DIMM Block Diagram (2 Banks, x8 DDR SDRAMs)

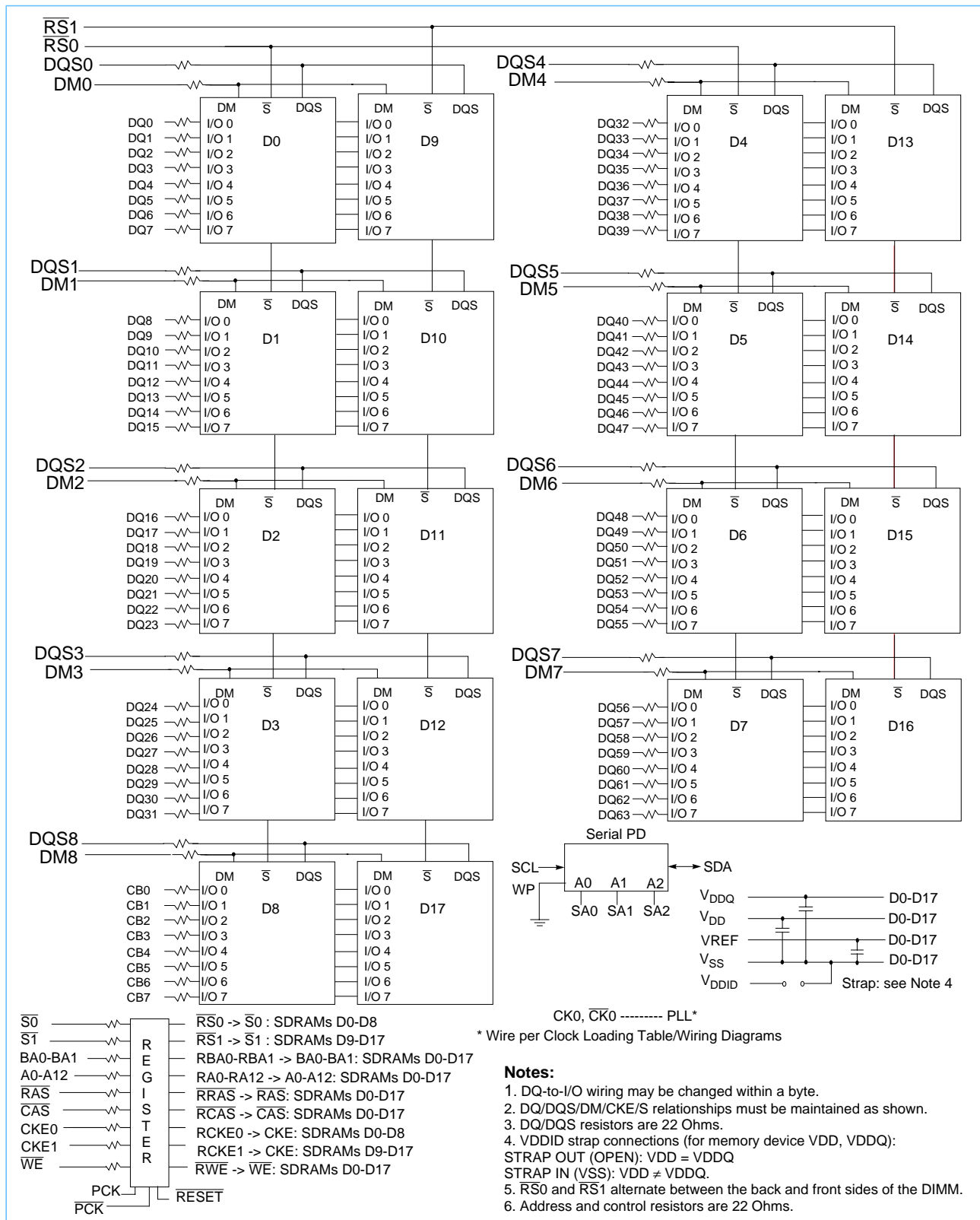

x64 ECC DDR Registered SDRAM DIMM Block Diagram (1 Bank, x8 DDR SDRAMs)

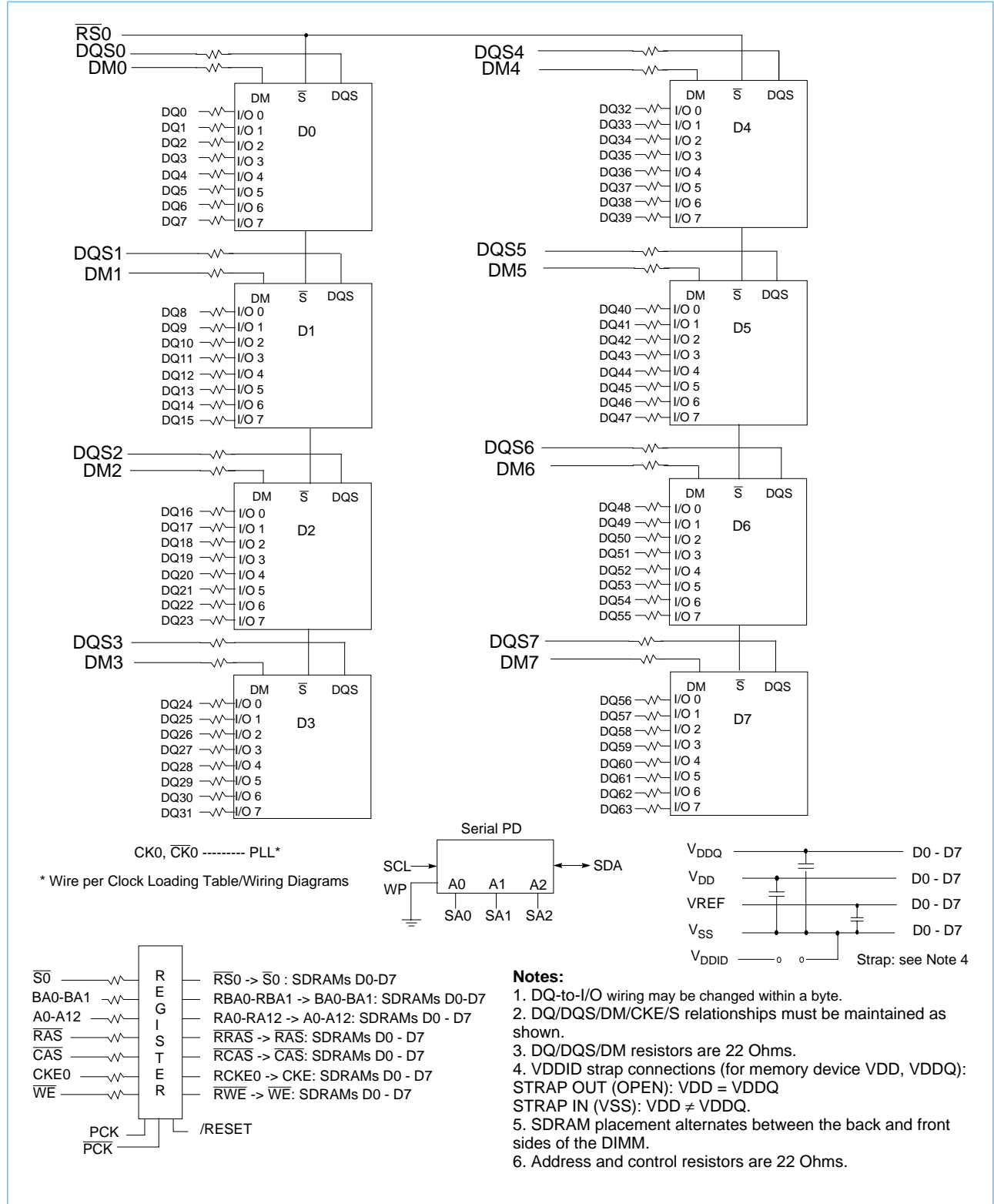

x64 ECC DDR Registered SDRAM DIMM Block Diagram (2 Banks, x8 DDR SDRAMs)

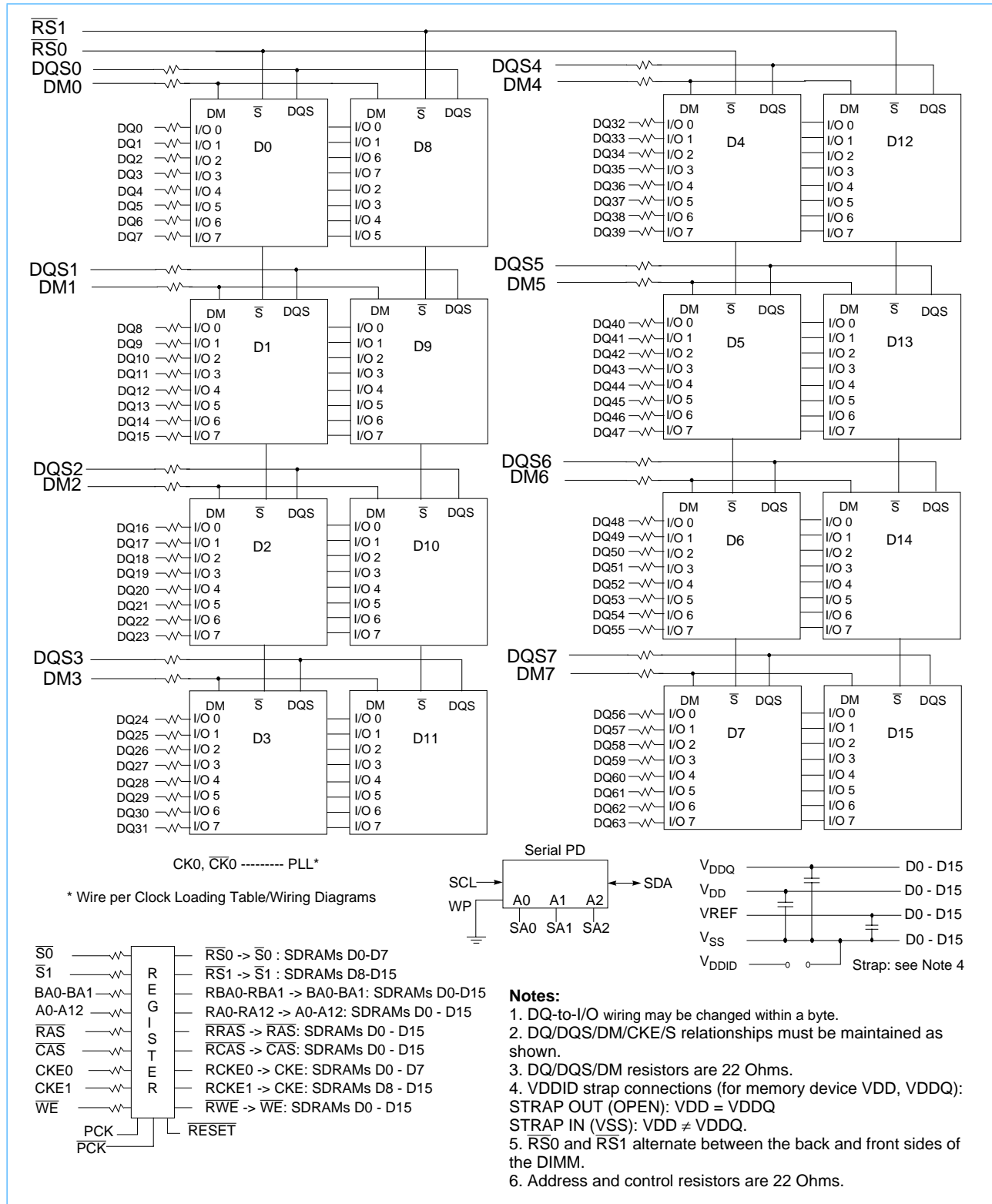



Input/Output Functional Description

Symbol	Type	Polarity	Function
CK0	(SSTL)	Positive Edge	The positive line of the differential pair of system clock inputs which drives the input to the on-DIMM PLL. All the DDR SDRAM addr/cnt inputs are sampled on the rising edge of their associated clocks.
$\overline{CK0}$	(SSTL)	Negative Edge	The negative line of the differential pair of system clock inputs which drives the input to the on-DIMM PLL.
CKE0, CKE1	(SSTL)	Active High	Activates the SDRAM CK signal when high and deactivates the CK signal when low. By deactivating the clocks, CKE low initiates the Power Down mode, or the Self Refresh mode.
$\overline{S0}, \overline{S1}$	(SSTL)	Active Low	Enables the associated SDRAM command decoder when low and disables the command decoder when high. When the command decoder is disabled, new commands are ignored but previous operations continue.
$\overline{RAS}, \overline{CAS}, \overline{WE}$	(SSTL)	Active Low	When sampled at the positive rising edge of the clock, \overline{CAS} , \overline{RAS} , and \overline{WE} define the operation to be executed by the SDRAM.
V_{REF}	Supply		Reference voltage for SSTL-2 inputs
V_{DDQ}	Supply		Isolated power supply for the DDR SDRAM output buffers to provide improved noise immunity
BA0,1	(SSTL)	—	Selects which SDRAM bank of four is activated.
A0 - A9, A11, A12, A10/AP	(SSTL)	—	During a Bank Activate command cycle, A0-A12 defines the row address (RA0-RA12) when sampled at the rising clock edge. During a Read or Write command cycle, A0-A9 defines the column address (CA0-CA9) when sampled at the rising clock edge. In addition to the column address, AP is used to invoke auto-precharge operation at the end of the burst read or write cycle. If AP is high, autoprecharge is selected and BA0, BA1 defines the bank to be precharged. If AP is low, autoprecharge is disabled. During a Precharge command cycle, AP is used in conjunction with BA0, BA1 to control which bank(s) to precharge. If AP is high, all banks will be precharged regardless of the state of BA0 or BA1. If AP is low, BA0 and BA1 are used to define which bank to precharge.
DQ0 - DQ63, CB0 - CB7	(SSTL)	—	Data and Check Bit Input/Output pins. Check bits are only applicable on the x72 DIMM configurations.
DM0-DM8	(SSTL)	Active High	Masks write data when high, issued concurrently with input data. Both DM and DQ have a write latency of one clock once the write command is registered into the SDRAM.
V_{DD}, V_{SS}	Supply		Power and ground for the DDR SDRAM input buffers and core logic
DQS0-DQS8	(SSTL)	Negative and Positive Edge	Data strobe for input and output data
RESET	(LVC-MOS)	Active Low	Asynchronously forces all register outputs low when RESET is low. This signal can be used during power up to ensure CKE0/1 are low and SDRAM DQS are Hi-Z.
SA0 - 2		—	These signals are tied at the system planar to either V_{SS} or V_{DD} to configure the serial SPD EEPROM address range.
SDA		—	This bidirectional pin is used to transfer data into or out of the SPD EEPROM. A resistor must be connected from the SDA bus line to V_{DD} to act as a pullup.
SCL		—	This signal is used to clock data into and out of the SPD EEPROM. A resistor may be connected from the SCL bus time to V_{DD} to act as a pullup.
V_{DDSPD}	Supply		Serial EEPROM positive power supply.

Serial Presence Detect (Part 1 of 3)

Byte #	Description	SPD Entry Value	Serial PD Data Entry (Hexadecimal)	Notes
0	Number of Serial PD Bytes Written during Production	128	80	
1	Total number of bytes in Serial PD Device	256	08	
2	Fundamental Memory Type	SDRAM DDR	07	
3	Number of Row Addresses on Assembly	13	0D	
4	Number of Column Addresses on Assembly	10	0A	
5	Number of Physical Banks on DIMM	32Mx64, 72	01	
		64Mx64, 72	02	
6-7	Data Width of Assembly	32M, 64Mx64	x64	4000
		32M, 64Mx72	x72	4800
8	Voltage Interface Level of this Assembly	SSTL 2.5V	04	
9	SDRAM Device Cycle Time at Maximum CL (CLX = 2.5)	PC200	8.0ns	80
		PC266B	7.5ns	
10	SDRAM Device Access Time from Clock at CL=2.5	PC200	0.8ns	80
		PC266B	0.75ns	
11	DIMM Configuration Type	32M, 64Mx64	Non-parity	00
		32M, 64Mx72	ECC	02
12	Refresh Rate/Type	7.8µs/SR	82	
13	Primary SDRAM Device Width	x8	08	
14	Error Checking SDRAM Device Width	x8	08	
15	SDRAM Device Attributes: Minimum Clock Delay, Random Column Access	1 Clock	01	
16	SDRAM Device Attributes: Burst Lengths Supported	2, 4, 8	0E	
17	SDRAM Device Attributes: Number of Device Banks	4	04	
18	SDRAM Device Attributes: $\overline{\text{CAS}}$ Latency	2, 2.5	0C	
19	SDRAM Device Attributes: $\overline{\text{CS}}$ Latency	0	01	
20	SDRAM Device Attributes: $\overline{\text{WE}}$ Latency	1	02	
21	SDRAM Module Attributes	Registered with PLL, Differential clock	26	
22	SDRAM Device Attributes: General	$V_{DD} \pm 0.2V$	00	
23	Minimum Clock Cycle at CLX-0.5 (CL = 2)	PC200	10.0ns	A0
		PC266B	8.0ns	80
24	Maximum Data Access Time (t_{AC}) from Clock at CLX-0.5 (CL = 2)	PC200	$\pm 0.8ns$	80
		PC266B	$\pm 0.75ns$	75
25	Minimum Clock Cycle Time at CLX-1 (CL = 1.5)	N/A	00	

1. In a registered DIMM, data is delayed an additional clock cycle due to the on-DIMM pipeline register (that is, Device CL [clock cycles] + 1 = DIMM $\overline{\text{CAS}}$ latency).
2. cc = Checksum Data byte, 00-FF (Hex).
3. "R" = Alphanumeric revision code, A-Z, 0-9.
4. rr = ASCII coded revision code byte "R".
5. ww = Binary coded decimal week code, 01-52 (Decimal) ' 01-34 (Hex).
6. yy = Binary coded decimal year code, 00-99 (Decimal) ' 00-63 (Hex).
7. ss = Serial number data byte, 00-FF (Hex).
8. Setup and hold values assume a 1 Volt/ns slew rate.



Serial Presence Detect (Part 2 of 3)

Byte #	Description	SPD Entry Value	Serial PD Data Entry (Hexadecimal)	Notes	
26	Maximum Data Access Time (t_{AC}) from Clock at CLX-1 (CL = 1.5)	N/A	00		
27	Minimum Row Precharge Time (t_{RP})	20.0ns	50		
28	Minimum Row Active to Row Active Delay (t_{RRD})	15.0ns	3C		
29	Minimum \overline{RAS} to CAS Delay (t_{RCD})	20.0ns	50		
30	Minimum Active to Precharge Time (t_{RAS})	PC200	50.0ns	32	
		PC266B	45.0ns	2D	
31	Module Bank Density - 32Mx64, x72	256MB	40		
32	Address and Command Setup Time before Clock	PC200	1.2ns	C0	
		PC266B	1.0ns	A0	
33	Address and Command Hold Time after Clock	PC200	1.2ns	C0	
		PC266B	1.0ns	A0	
34	Data/Data Mask Input Setup Time before Clock	PC200	0.6ns	60	
		PC266B	1.0ns	A0	
35	Data/Data Mask Input Hold Time after Clock	PC200	0.6ns	60	
		PC266B	1.0ns	A0	
36-61	Reserved	Undefined	00		
62	SPD Revision	0	00		
63	Checksum for Bytes 0 - 62	Checksum Data	cc	2	
64-71	Manufacturers' JEDEC ID Code	IBM	A400000000000000		
72	Module Manufacturing Location	Toronto, Canada	91		
		Vimercate, Italy	53		
73-90	Module Part Number	PC200	32Mx64	ASCII '16M32644HG"R" -10HT	31364D33323634344847rr 2D313048542020
			32Mx72	ASCII '16M32734HG"R" -10HT	31364D33323733344847rr 2D313048542020
			64Mx64	ASCII '16M64644HG"R" -10HT	31364D36343634344847rr 2D313048542020
			64Mx72	ASCII '16M64734HG"R" -10HT	31364D36343733344847rr 2D313048542020
		PC266B	32Mx64	ASCII '16M32644HG"R" -8ET	31364D33323634344847rr 2D384554202020
			32Mx72	ASCII '16M32734HG"R" -8ET	31364D33323733344847rr 2D384554202020
			64Mx64	ASCII '16M64644HG"R" -8ET	31364D36343634344847rr 2D384554202020
			64Mx72	ASCII '16M64734HG"R" -8ET	31364D36343733344847rr 2D384554202020
91-92	Module Revision Code	"R" plus ASCII blank	rr20	4	
93-94	Module Manufacturing Date	Year/Week Code	yyww	5, 6	

1. In a registered DIMM, data is delayed an additional clock cycle due to the on-DIMM pipeline register (that is, Device CL [clock cycles] + 1 = DIMM \overline{CAS} latency).
2. cc = Checksum Data byte, 00-FF (Hex).
3. "R" = Alphanumeric revision code, A-Z, 0-9.
4. rr = ASCII coded revision code byte "R".
5. ww = Binary coded decimal week code, 01-52 (Decimal) ' 01-34 (Hex).
6. yy = Binary coded decimal year code, 00-99 (Decimal) ' 00-63 (Hex).
7. ss = Serial number data byte, 00-FF (Hex).
8. Setup and hold values assume a 1 Volt/ns slew rate.



Serial Presence Detect (Part 3 of 3)

Byte #	Description	SPD Entry Value	Serial PD Data Entry (Hexadecimal)	Notes
95-98	Module Serial Number	Serial Number	ssssssss	7
99-127	Reserved	Undefined	00	
128-255	Open for Customer Use	Undefined	00	

1. In a registered DIMM, data is delayed an additional clock cycle due to the on-DIMM pipeline register (that is, Device CL [clock cycles] + 1 = DIMM $\overline{\text{CAS}}$ latency).
2. cc = Checksum Data byte, 00-FF (Hex).
3. "R" = Alphanumeric revision code, A-Z, 0-9.
4. rr = ASCII coded revision code byte "R".
5. ww = Binary coded decimal week code, 01-52 (Decimal) ' 01-34 (Hex).
6. yy = Binary coded decimal year code, 00-99 (Decimal) ' 00-63 (Hex).
7. ss = Serial number data byte, 00-FF (Hex).
8. Setup and hold values assume a 1 Volt/ns slew rate.



Absolute Maximum Ratings

Symbol	Parameter	Rating	Units	
V_{IN}, V_{OUT}	Voltage on I/O pins relative to V_{SS}	-0.5 to $V_{DDQ} + 0.5$	V	
V_{IN}	Voltage on Inputs relative to V_{SS}	SDRAM device	-0.5 to +2.7	V
		Serial PD device	-0.3 to +6.5	V
V_{DD}	Voltage on V_{DD} supply relative to V_{SS}	-0.5 to +2.7	V	
V_{DDQ}	Voltage on V_{DDQ} supply relative to V_{SS}	-0.5 to +2.7	V	
V_{DDSPD}	Voltage on V_{DDSPD} supply relative to V_{SS}	-0.3 to +5.5	V	
T_A	Operating Temperature (Ambient)	0 to +70	°C	
T_{STG}	Storage Temperature (Plastic)	-55 to +150	°C	
P_D	Power Dissipation	TBD	W	
I_{OUT}	Short Circuit Output Current	50	mA	

Note: Stresses greater than those listed under “Absolute Maximum Ratings” may cause permanent damage to the device. This is a stress rating only, and functional operation of the device at these or any other conditions above those indicated in the operational sections of this specification is not implied. Exposure to absolute maximum rating conditions for extended periods may affect reliability.

Capacitance

Parameter	Symbol	Max.	Units	Notes	
Input Capacitance: $CK_0, \overline{CK_0}$	C_{I1}	7	pF	1	
Input Capacitance: $A_0-A_{12}, BA_0, BA_1, \overline{WE}, \overline{RAS}, \overline{CAS}, CKE_0, CKE_1, \overline{SO}, \overline{S1}$	C_{I2}	7	pF	1	
Input Capacitance: \overline{RESET}	C_{I3}	7	pF	1	
Input Capacitance: SA_0-SA_2, SCL	C_{I4}	9	pF	1	
Input/Output Capacitance: $DQ_0-63, DQS_0-8, DM_0-8, CB_0-7$	32Mx64/72	C_{IO1}	10	pF	1, 2, 3
	64Mx64/72	C_{IO2}	15	pF	
Input/Output Capacitance: SDA	C_{IO3}	11	pF		

- $V_{DDQ} = V_{DD} = 2.5V \pm 0.2V, f = 100MHz, T_A = 25^\circ C, V_{OUT} (DC) = V_{DDQ}/2, V_{OUT} (Peak to Peak) = 0.2V.$
- DM inputs are grouped with I/O pins reflecting the fact that they are matched in loading to DQ and DQS to facilitate trace matching at the board level.
- CB_0-7, DQS_8 and DM_8 are used on x72 DIMM configurations only.

Electrical Characteristics and DC Operating Conditions

(0°C ≤ T_A ≤ 70°C; V_{DDQ} = 2.5V ± 0.2V, V_{DD} = + 2.5V ± 0.2V, see AC Characteristics)

Symbol	Parameter	Min	Max	Units	Notes	
V _{DD}	Supply Voltage	2.3	2.7	V	1	
V _{DDQ}	I/O Supply Voltage	2.3	2.7	V	1	
V _{SS} , V _{SSQ}	Supply Voltage I/O Supply Voltage	0	0	V		
V _{REF}	I/O Reference Voltage	1.15	1.35	V	1, 2	
V _{TT}	I/O Termination Voltage (System)	V _{REF} - 0.04	V _{REF} + 0.04	V	1, 3	
V _{DDSPD}	Supply Voltage SPD Supply Voltage	2.3	2.7	V		
V _{IH(DC)}	Input High (Logic1) Voltage	DQ0-63, CB0-7, DQS0-8, DM0-8	V _{REF} + 0.15	V _{DDQ} + 0.3	V	1
		Address and control inputs	V _{REF} + 0.18	V _{DDQ} + 0.3		
		RESET	1.7	V _{DDQ} + 0.3		
V _{IL(DC)}	Input Low (Logic0) Voltage	DQ0-63, CB0-7, DQS0-8, DM0-8	- 0.3	V _{REF} - 0.15	V	1
		Address and control inputs	-0.3	V _{REF} - 0.18		
		RESET	- 0.3	0.8		
V _{IN(DC)}	Input Voltage Level, CK and $\overline{\text{CK}}$ Inputs	- 0.3	V _{DDQ} + 0.3	V	1	
V _{ID(DC)}	Input Differential Voltage, CK and $\overline{\text{CK}}$ Inputs	0.36	V _{DDQ} + 0.6	V	1, 4	
I _I	Input Leakage Current Any input 0V ≤ V _{IN} ≤ V _{DD} (All other pins not under test = 0V)	Address and control inputs	- 5	5	μA	1
		DQ0-63, CB0-7, DQS0-8, DM0-8	- 5	5		
		CK and $\overline{\text{CK}}$	- 10	10		
I _{OZ}	Output Leakage Current (DQs are disabled; 0V ≤ V _{out} ≤ V _{DDQ})	DQ0-63, CB0-7, DQS0-8, DM0-8	- 5	5	μA	1
		SDA	- 1	1		
I _{OH}	Output High Current (V _{OUT} = 1.95V)	- 15.2		mA	1	
I _{OL}	Output Low Current (V _{OUT} = 0.35V)	15.2		mA	1	

- Inputs are not recognized as valid until V_{REF} stabilizes.
- V_{REF} is expected to be equal to 0.5 V_{DDQ} of the transmitting device, and to track variations in the DC level of the same. Peak-to-peak noise on V_{REF} may not exceed 2% of the DC value.
- V_{TT} is not applied directly to the DIMM. V_{TT} is a system supply for signal termination resistors, is expected to be set equal to V_{REF} and must track variations in the DC level of V_{REF}.
- V_{ID} is the magnitude of the difference between the input level on CK and the input level on $\overline{\text{CK}}$.

AC Characteristics

(Notes 1-5 apply to the following Tables; Electrical Characteristics and DC Operating Conditions, AC Operating Conditions, Operating, Standby, and Refresh Currents, and Electrical Characteristics and AC Timing.)

1. All voltages referenced to V_{SS} .
2. Tests for AC timing, I_{DD} , and electrical, AC and DC characteristics, may be conducted at nominal reference/supply voltage levels, but the related specifications and device operation are guaranteed for the full voltage range specified.
3. Outputs measured with equivalent load. Refer to the AC Output Load Circuit below.
4. AC timing and I_{DD} tests may use a V_{IL} to V_{IH} swing of up to 1.5V in the test environment, but input timing is still referenced to V_{REF} (or to the crossing point for CK, \overline{CK}), and parameter specifications are guaranteed for the specified AC input levels under normal use conditions. The minimum slew rate for the input signals is 1V/ns in the range between $V_{IL(AC)}$ and $V_{IH(AC)}$ unless otherwise specified.
5. The AC and DC input level specifications are as defined in the SSTL_2 Standard (i.e. the receiver effectively switches as a result of the signal crossing the AC input level, and remains in that state as long as the signal does not ring back above (below) the DC input LOW (HIGH) level.

AC Output Load Circuit Diagram

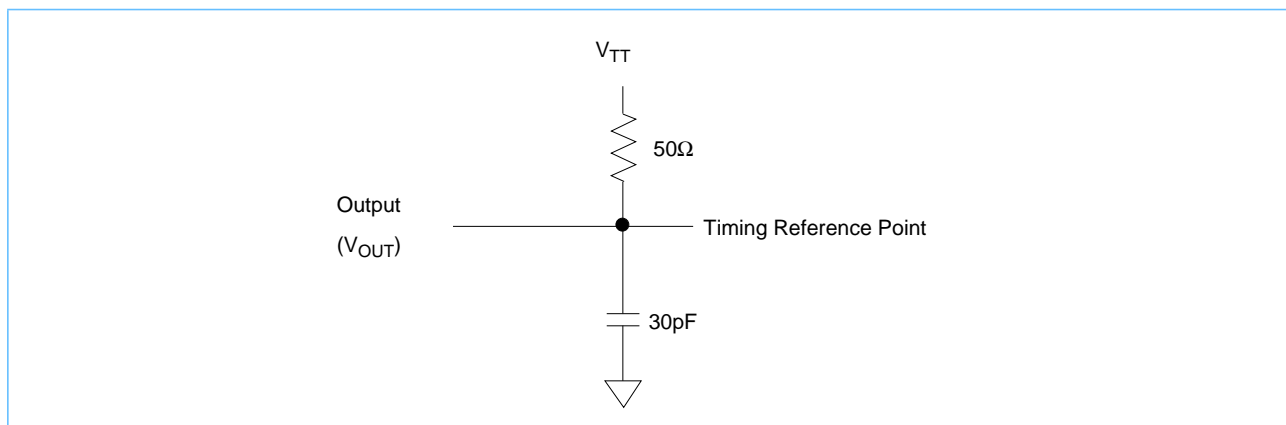

AC Operating Conditions ($0^\circ\text{C} \leq T_A \leq 70^\circ\text{C}$; $V_{DDQ} = 2.5\text{V} \pm 0.2\text{V}$; $V_{DD} = 2.5\text{V} \pm 0.2\text{V}$, See AC Characteristics)

Symbol	Parameter/Condition	Min	Max	Unit	Notes	
$V_{IH(AC)}$	Input High (Logic 1) Voltage.	DQ0-63, CB0-7, DQS0-8, DM0-8	$V_{REF} + 0.31$		V	1, 2
		Address and control inputs	$V_{REF} + 0.35$			
$V_{IL(AC)}$	Input Low (Logic 0) Voltage.	DQ0-63, CB0-7, DQS0-8, DM0-8		$V_{REF} - 0.31$	V	1, 2
		Address and control inputs		$V_{REF} - 0.35$		
$V_{ID(AC)}$	Input Differential Voltage, CK and \overline{CK} Inputs	0.7	$V_{DDQ} + 0.6$	V	1, 2, 3	
$V_{IX(AC)}$	Input Differential Pair Cross Point Voltage, CK and \overline{CK} Inputs	$(0.5 \cdot V_{DDQ}) - 0.2$	$(0.5 \cdot V_{DDQ}) + 0.2$	V	1, 2, 4	
f_{SSC}	SSC modulation frequency	30	50	KHz		
Δ_{SSC}		0	-50	%		

1. Input slew rate = 1V/ns.
2. Inputs are not recognized as valid until V_{REF} stabilizes.
3. V_{ID} is the magnitude of the difference between the input level on CK and the input level on \overline{CK} .
4. The value of V_{IX} is expected to equal $0.5 \cdot V_{DDQ}$ of the transmitting device and must track variations in the DC level of the same.

Operating, Standby, and Refresh Currents ($0^{\circ}\text{C} \leq T_A \leq 70^{\circ}\text{C}$; $V_{DDQ} = 2.5\text{V} \pm 0.2\text{V}$; $V_{DD} = 2.5\text{V} \pm 0.2\text{V}$, See AC Characteristics)

Symbol	Parameter/Condition	x72		x64		Unit	Notes
		2 Bank	1 Bank	2 Bank	1 Bank		
I_{DD0}	Operating Current: one bank; active / precharge; $t_{RC} = t_{RC\ MIN}$; $t_{CK} = t_{CK\ MIN}$; DQ, DM, and DQS inputs changing twice per clock cycle; address and control inputs changing once per clock cycle	TBD	TBD	TBD	TBD	mA	1, 2
I_{DD1}	Operating Current: one bank; active / read / precharge; Burst = 2; $t_{RC} = t_{RC\ MIN}$; CL = 2.5; $t_{CK} = t_{CK\ MIN}$; $I_{OUT} = 0\text{mA}$; address and control inputs changing once per clock cycle	TBD	TBD	TBD	TBD	mA	1, 2
I_{DD2P}	Precharge Power-Down Standby Current: all banks idle; power-down mode; $CKE \leq V_{IL\ MAX}$; $t_{CK} = t_{CK\ MIN}$	TBD	TBD	TBD	TBD	mA	1, 2
I_{DD2N}	Idle Standby Current: $\overline{CS} \geq V_{IH\ MIN}$; all banks idle; $CKE \geq V_{IH\ MIN}$; $t_{CK} = t_{CK\ MIN}$; address and control inputs changing once per clock cycle	TBD	TBD	TBD	TBD	mA	1, 2
I_{DD3P}	Active Power-Down Standby Current: one bank active; power-down mode; $CKE \leq V_{IL\ MAX}$; $t_{CK} = t_{CK\ MIN}$	TBD	TBD	TBD	TBD	mA	1, 2
I_{DD3N}	Active Standby Current: one bank; active / precharge; $\overline{CS} \geq V_{IH\ MIN}$; $CKE \geq V_{IH\ MIN}$; $t_{RC} = t_{RAS\ MAX}$; $t_{CK} = t_{CK\ MIN}$; DQ, DM, and DQS inputs changing twice per clock cycle; address and control inputs changing once per clock cycle	TBD	TBD	TBD	TBD	mA	1, 2
I_{DD4R}	Operating Current: one bank; Burst = 2; reads; continuous burst; address and control inputs changing once per clock cycle; DQ and DQS outputs changing twice per clock cycle; CL = 2.5; $t_{CK} = t_{CK\ MIN}$; $I_{OUT} = 0\text{mA}$	TBD	TBD	TBD	TBD	mA	1, 2
I_{DD4W}	Operating Current: one bank; Burst = 2; writes; continuous burst; address and control inputs changing once per clock cycle; DQ and DQS inputs changing twice per clock cycle; CL = 2.5; $t_{CK} = t_{CK\ MIN}$	TBD	TBD	TBD	TBD	mA	1, 2
I_{DD5}	Auto-Refresh Current: $t_{RC} = t_{RFC\ MIN}$	TBD	TBD	TBD	TBD	mA	1, 2
I_{DD6}	Self-Refresh Current: $CKE \leq 0.2\text{V}$	TBD	TBD	TBD	TBD	mA	1, 2, 3

1. I_{DD} specifications are tested after the device is properly initialized.
2. Input slew rate = 1V/ns.
3. Enables on-chip refresh and address counters.



Electrical Characteristics & AC Timing

(0 °C ≤ T_A ≤ 70 °C; V_{DDQ} = 2.5V ± 0.2V; V_{DD} = 2.5V ± 0.2V, See AC Characteristics) (Part 1 of 3)

Symbol	Parameter	PC266B		PC200		Unit	Notes	
		Min	Max	Min	Max			
t _{AC}	DQ output access time from CK/ $\overline{\text{CK}}$	- 0.75	+ 0.75	- 0.8	+ 0.8	ns	1-4, 9	
t _{DQSCK}	DQS output access time from CK/ $\overline{\text{CK}}$	- 0.75	+ 0.75	- 0.8	+ 0.8	ns	1-4, 9	
t _{CH}	CK high-level width	0.40	0.60	0.40	0.60	t _{CK}	1, 2	
t _{CL}	CK low-level width	0.40	0.60	0.40	0.60	t _{CK}	1, 2	
t _{CK}	Clock cycle time	DIMM CL = 3.5	7.5	15	8	15	ns	1, 2
t _{CK}		DIMM CL = 3.0	8	15	10	15	ns	1, 2
t _{DH}	DQ and DM input hold time (to DQS)	0.5		0.6		ns	1, 3	
t _{DS}	DQ and DM input setup time (to DQS)	0.5		0.6		ns	1, 3	
t _{DIPW}	DQ and DM input pulse width (each input)	1.75		2		ns	1, 3	
t _{HZ}	Data-out high-impedance time from CK/ $\overline{\text{CK}}$	- 0.75	+ 0.75	- 0.8	+ 0.8	ns	1-4, 5, 9	
t _{LZ}	Data-out low-impedance time from CK/ $\overline{\text{CK}}$	- 0.75	+ 0.75	- 0.8	+ 0.8	ns	1-4, 5, 9	
t _{DQSQ}	DQS-DQ skew (DQS & associated DQ signals)		+ 0.5		+ 0.6	ns	1, 3, 4	
t _{DQSQA}	DQS-DQ skew (DQS & all DQ signals)		+ 0.5		+ 0.6	ns	1, 3, 4	
t _{QH}	Data output hold from DQS output valid time	t _{CH/CL} (Min) -1.0 ns		t _{CH/CL} (Min) -0.75 ns		ns	1, 3, 4	
t _{DQSS}	Write command to first DQS latching transition	0.75	1.25	0.75	1.25	t _{CK}	1, 2, 3, 9	

1. Input slew rate = 1V/ns
2. The CK/ $\overline{\text{CK}}$ input reference level (for timing reference to CK/ $\overline{\text{CK}}$) is the point at which CK and $\overline{\text{CK}}$ cross: the input reference level for signals other than CK/ $\overline{\text{CK}}$, is V_{REF}.
3. Inputs are not recognized as valid until V_{REF} stabilizes.
4. The Output timing reference level, as measured at the timing reference point indicated in AC Characteristics (Note 3) is V_{TT}.
5. t_{HZ} and t_{LZ} transitions occur in the same access time windows as valid data transitions. These parameters are not referred to a specific voltage level, but specify when the device is no longer driving (HZ), or begins driving (LZ).
6. The maximum limit for this parameter is not a device limit. The device operates with a greater value for this parameter, but system performance (bus turnaround) degrades accordingly.
7. The specific requirement is that DQS be valid (HIGH, LOW, or some point on a valid transition) on or before this CK edge. A valid transition is defined as monotonic and meeting the input slew rate specifications of the device. When no writes were previously in progress on the bus, DQS will be transitioning from Hi-Z to logic LOW. If a previous write was in progress, DQS could be HIGH, LOW, or transitioning from HIGH to LOW at this time, depending on t_{DQSS}.
8. A maximum of eight Autorefresh commands can be posted to any given DDR SDRAM device.
9. This parameter is specified at the SDRAM. For system-level timing analysis, the on-DIMM clock skew must be included in addition to the SDRAM timing parameter (0.20ns).
10. This command is specified at the SDRAM. For system-level timing analysis simulation of the DIMM design file is highly recommended. This simulation will take into account DIMM adders to the specified values.
11. This parameter is specified at the register input receiver and includes DIMM-related timing adjustments. Simulation with the DIMM design file is highly recommended.
12. The time from asynchronous switching of $\overline{\text{RESET}}$ from low to high until the registers are stable and ready to accept an input signal.
13. The time in which the system must maintain valid levels on the clocks and address and control signals after the $\overline{\text{RESET}}$ low has been applied.

Electrical Characteristics & AC Timing

(0 °C ≤ T_A ≤ 70 °C; V_{DDQ} = 2.5V ± 0.2V; V_{DD} = 2.5V ± 0.2V, See AC Characteristics) (Part 2 of 3)

Symbol	Parameter	PC266B		PC200		Unit	Notes
		Min	Max	Min	Max		
t _{DQSL,H}	DQS input low (high) pulse width (write cycle)	0.35		0.35		t _{CK}	1, 3
t _{DSS}	DQS falling edge to CK setup time (write cycle)	0.2		0.2		t _{CK}	1, 2, 3, 9
t _{DSH}	DQS falling edge hold time from CK (write cycle)	0.2		0.2		t _{CK}	1, 2, 3, 9
t _{MRD}	Mode register set command cycle time	15		16		ns	1, 2, 3
t _{WPRES}	Write preamble setup time	0		0		ns	1, 2, 3, 7, 9
t _{WPST}	Write postamble	0.40	0.60	0.40	0.60	t _{CK}	1, 3, 6
t _{WPRE}	Write preamble	0.25		0.25		t _{CK}	1, 3
t _{IH}	Address and control input hold time	Input slew rate ≥ 1 V/ns	0.95		0.95	ns	11
		Input slew rate ≥ 0.5, < 1 V/ns	1.1		1.1		
t _{IS}	Address and control input setup time	Input slew rate ≥ 1 V/ns	0.95		0.95	ns	11
		Input slew rate ≥ 0.5, < 1 V/ns	1.1		1.1		
t _{ACT}	Register activation time	22	–	22	–	ns	12
t _{INACT}	Register deactivation time	22	–	22	–	ns	13
t _{RPRE}	Read preamble	0.9	1.1	0.9	1.1	t _{CK}	1, 3
t _{RPST}	Read postamble	0.40	0.60	0.40	0.60	t _{CK}	1, 3

1. Input slew rate = 1V/ns
2. The CK/ $\overline{\text{CK}}$ input reference level (for timing reference to CK/ $\overline{\text{CK}}$) is the point at which CK and $\overline{\text{CK}}$ cross: the input reference level for signals other than CK/ $\overline{\text{CK}}$, is V_{REF}.
3. Inputs are not recognized as valid until V_{REF} stabilizes.
4. The Output timing reference level, as measured at the timing reference point indicated in AC Characteristics (Note 3) is V_{TT}.
5. t_{HZ} and t_{LZ} transitions occur in the same access time windows as valid data transitions. These parameters are not referred to a specific voltage level, but specify when the device is no longer driving (HZ), or begins driving (LZ).
6. The maximum limit for this parameter is not a device limit. The device operates with a greater value for this parameter, but system performance (bus turnaround) degrades accordingly.
7. The specific requirement is that DQS be valid (HIGH, LOW, or some point on a valid transition) on or before this CK edge. A valid transition is defined as monotonic and meeting the input slew rate specifications of the device. When no writes were previously in progress on the bus, DQS will be transitioning from Hi-Z to logic LOW. If a previous write was in progress, DQS could be HIGH, LOW, or transitioning from HIGH to LOW at this time, depending on t_{DQSS}.
8. A maximum of eight Autorefresh commands can be posted to any given DDR SDRAM device.
9. This parameter is specified at the SDRAM. For system-level timing analysis, the on-DIMM clock skew must be included in addition to the SDRAM timing parameter (0.20ns).
10. This command is specified at the SDRAM. For system-level timing analysis simulation of the DIMM design file is highly recommended. This simulation will take into account DIMM adders to the specified values.
11. This parameter is specified at the register input receiver and includes DIMM-related timing adjustments. Simulation with the DIMM design file is highly recommended.
12. The time from asynchronous switching of $\overline{\text{RESET}}$ from low to high until the registers are stable and ready to accept an input signal.
13. The time in which the system must maintain valid levels on the clocks and address and control signals after the $\overline{\text{RESET}}$ low has been applied.



Electrical Characteristics & AC Timing

(0 °C ≤ T_A ≤ 70 °C; V_{DDQ} = 2.5V ± 0.2V; V_{DD} = 2.5V ± 0.2V, See AC Characteristics) (Part 3 of 3)

Symbol	Parameter	PC266B		PC200		Unit	Notes
		Min	Max	Min	Max		
t _{RAS}	Active to Precharge command	45	120,000	50	120,000	ns	1, 2, 3
t _{RC}	Active to Active/Auto-refresh command period	65		70		ns	1, 2, 3
t _{RFC}	Auto-refresh to Active/Auto-refresh command period	75		80		ns	1, 2, 3
t _{RCD}	Active to Read or Write delay	20		20		ns	1, 2, 3
t _{RP}	Precharge command period	20		20		ns	1, 2, 3
t _{RRD}	Active bank A to Active bank B command	15		15		ns	1, 2, 3
t _{WR}	Write recovery time	15		15		ns	1, 2, 3
t _{DAL}	Auto precharge write recovery + precharge time	35		35		ns	1, 2, 3
t _{WTR}	Internal write to read command delay	1		1		t _{CK}	1, 3
t _{XSNR}	Exit self-refresh to non-read command	75		80		ns	1, 3
t _{XSRD}	Exit self-refresh to read command	200		200		t _{CK}	1, 3
t _{REFI}	Average Periodic Refresh Interval		7.8		7.8	μs	1, 3, 8

1. Input slew rate = 1V/ns
2. The CK/ \overline{CK} input reference level (for timing reference to CK/ \overline{CK}) is the point at which CK and \overline{CK} cross: the input reference level for signals other than CK/ \overline{CK} , is V_{REF}.
3. Inputs are not recognized as valid until V_{REF} stabilizes.
4. The Output timing reference level, as measured at the timing reference point indicated in AC Characteristics (Note 3) is V_{TT}.
5. t_{HZ} and t_{LZ} transitions occur in the same access time windows as valid data transitions. These parameters are not referred to a specific voltage level, but specify when the device is no longer driving (HZ), or begins driving (LZ).
6. The maximum limit for this parameter is not a device limit. The device operates with a greater value for this parameter, but system performance (bus turnaround) degrades accordingly.
7. The specific requirement is that DQS be valid (HIGH, LOW, or some point on a valid transition) on or before this CK edge. A valid transition is defined as monotonic and meeting the input slew rate specifications of the device. When no writes were previously in progress on the bus, DQS will be transitioning from Hi-Z to logic LOW. If a previous write was in progress, DQS could be HIGH, LOW, or transitioning from HIGH to LOW at this time, depending on t_{DQSS}.
8. A maximum of eight Autorefresh commands can be posted to any given DDR SDRAM device.
9. This parameter is specified at the SDRAM. For system-level timing analysis, the on-DIMM clock skew must be included in addition to the SDRAM timing parameter (0.20ns).
10. This command is specified at the SDRAM. For system-level timing analysis simulation of the DIMM design file is highly recommended. This simulation will take into account DIMM adders to the specified values.
11. This parameter is specified at the register input receiver and includes DIMM-related timing adjustments. Simulation with the DIMM design file is highly recommended.
12. The time from asynchronous switching of \overline{RESET} from low to high until the registers are stable and ready to accept an input signal.
13. The time in which the system must maintain valid levels on the clocks and address and control signals after the \overline{RESET} low has been applied.

Wiring and Topology

This section contains the information needed to understand the timing relationships presented in the AC Characteristics section. Because the system designer must measure all signals at the first receiving device (SDRAM DQ pin for data, register input pin for address and controls, and PLL check input pin for clock), the following pages provide detailed information on these inputs. In some cases DIMM timing adjustments are listed in the specifications, and in some cases it is recommended that the customer determine this information via simulation. This section enables the customer to understand the device pinouts on the DIMM, the net structures, and the loading associated with these devices. For detailed timing analysis, contact an IBM Marketing Representative for simulation models. System-level modeling is strongly recommended to determine delay adders of the entire net structure in the customer's application.

Pin Assignments for the 256 Mbit DDR SDRAM Planar Component (top view)

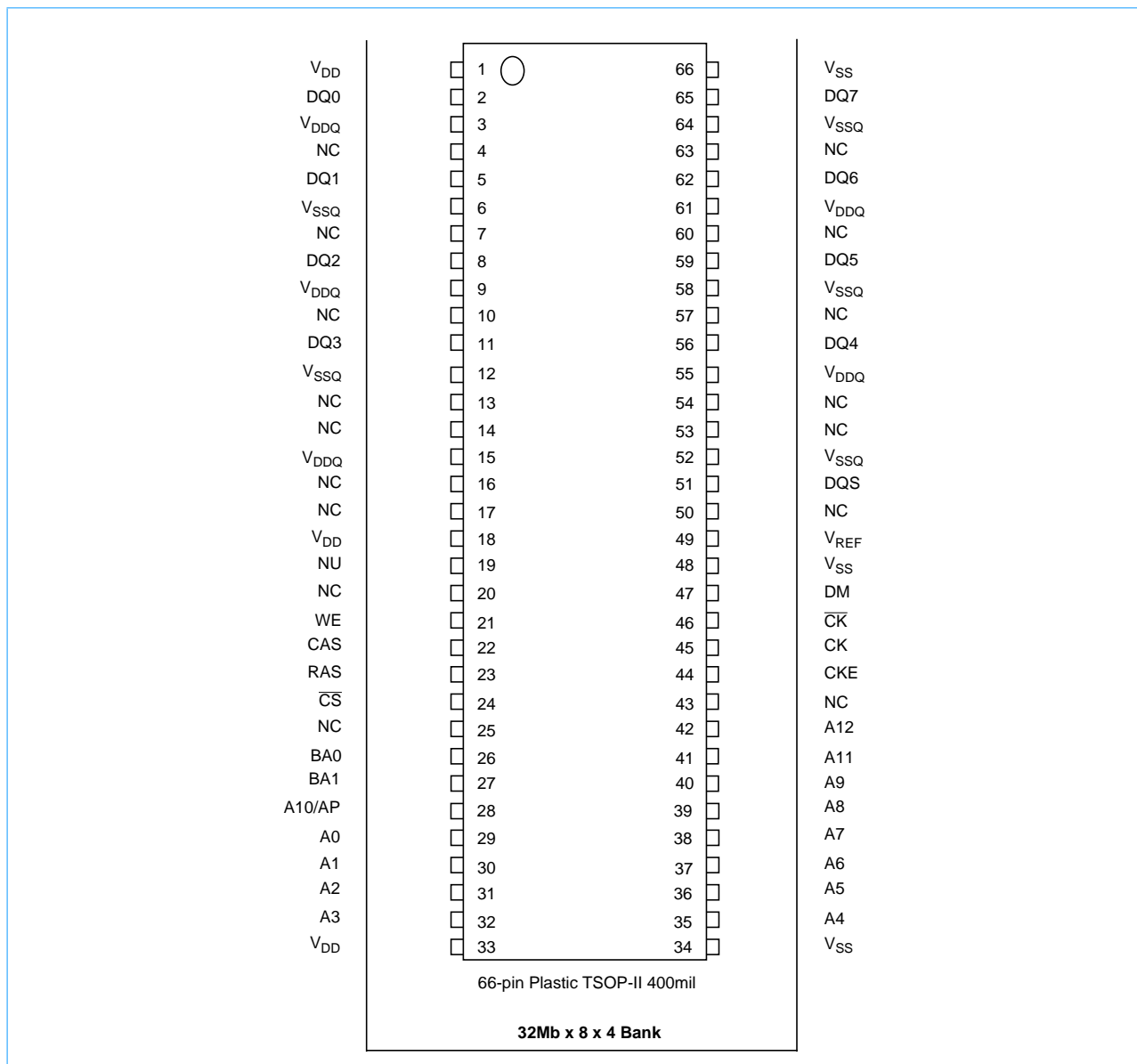



The table below describes the DQ and CB wiring information for each SDRAM on the DIMM. Note that the DQ wiring is different from that described in the Block Diagram.

SDRAM Wiring Information

DQ SDRAM Designator	DQ SDRAM Pin Number	Device Position to DIMM Tab I/O ¹																	
		D0	D1	D2	D3	D4	D5	D6	D7	D8	D9	D10	D11	D12	D13	D14	D15	D16	D17
DQ0	2	3	8	23	24	32	43	48	59	CB3	0	11	20	31	35	40	51	60	CB4
DQ1	5	7	12	19	28	36	47	52	63	CB7	4	15	16	27	39	44	55	56	CB5
DQ2	8	2	9	22	25	33	42	49	58	CB2	1	10	17	26	34	45	50	61	CB0
DQ3	11	6	13	18	29	37	46	53	62	CB6	5	14	21	30	38	41	54	57	CB1
DQ4	56	5	14	21	30	38	41	54	57	CB1	6	13	18	29	37	46	53	62	CB6
DQ5	59	1	10	17	26	34	45	50	61	CB0	2	9	22	25	33	42	49	58	CB2
DQ6	62	4	15	16	27	39	44	55	56	CB5	7	12	19	28	36	47	52	63	CB7
DQ7	65	0	11	20	31	35	40	51	60	CB4	3	8	23	24	32	43	48	59	CB3

1. These numbers can be associated with the corresponding DIMM tab pin by referencing the DIMM connector pinout on pages 5 and 6 of this document. Example: DQ7 at the DIMM tab (pin 99) is wired to SDRAM device position D0, pin 5 and D9, pin 62.

Note: 64Mx72 uses DDR SDRAM device positions D0-D17
 64Mx64 uses D0-D15 only
 32Mx72 uses D0-D8 only
 32Mx64 uses D0-D7 only

Data, CB, DQS, and DM Net Structures

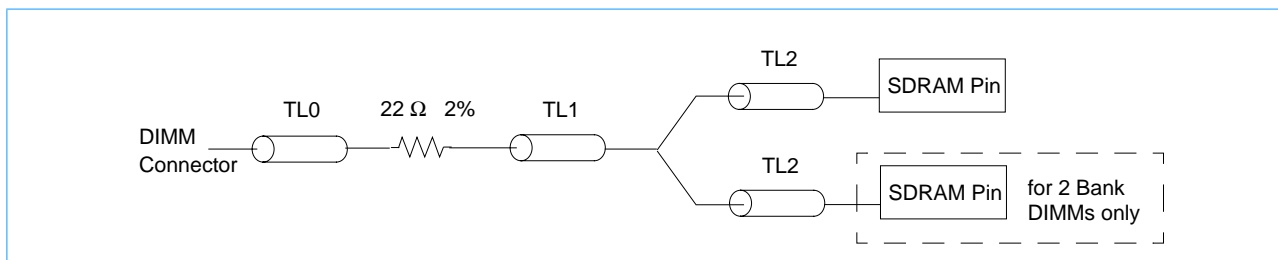

Note: Transmission Lines (TL) are represented as cylinders and are labeled with length designators. These are the only lines which represent physical trace segments. For more detailed topology information please refer to the DDR SDRAM Registered DIMM Design Specification.

Trace Lengths for Data Net Structure

TL0		TL1		TL2		Total		Unit
Min	Max	Min	Max	Min	Max	Min	Max	
0.125	0.193	0.581	0.670	0.370	0.439	1.145	1.296	inches

The table below describes the input wiring for each clock on the DIMM.

Clock Input Wiring

CK0, $\overline{\text{CK0}}$	CK1, $\overline{\text{CK1}}$, CK2, $\overline{\text{CK2}}$
PLL CLK input pin 13, 14	NC

Clock Topology

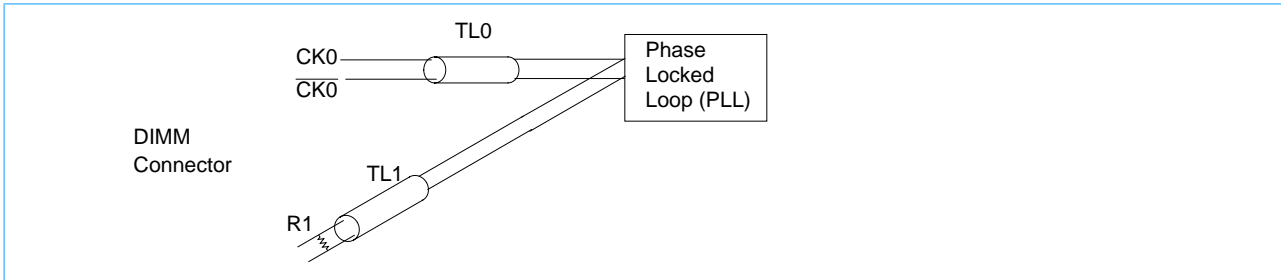

Trace Lengths

TL0	TL1	R1 [ohms]	Unit
1.00	0.066	120	inches

The table below describes the address and control information for each signal on the DIMM.

Register Input Wiring

Register Pin Number	Register 1 Signal	Register 2 Signal	Notes
25	NC	A0	
26	CKE1	A10	1
29	CKE0	BA1	
30	A12	NC	
31	A11	BA0	
32	A9	$\overline{\text{RAS}}$	
33	A7	$\overline{\text{WE}}$	
40	A8	NC	
41	A5	NC	
42	A6	NC	
43	A4	$\overline{\text{SI}}$	1
44	A3	$\overline{\text{CAS}}$	
47	A2	$\overline{\text{S0}}$	
48	A1	NC	

1. CKE1 and $\overline{\text{SI}}$ register inputs are grounded and are NC at the DIMM connector in the single bank cases.

Address/Control Signal Net Structure

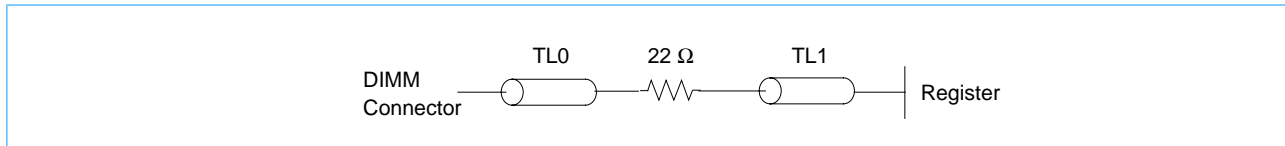

Trace Lengths

TL0		TL1		Units
Min	Max	Min	Max	
0.131	0.225	0.563	0.665	inches

Note: Each signal has one register input load in order to aid in system level timings.



Functional Description and Timing Diagrams

Refer to IBM 256Mb Synchronous DDR DRAM datasheet (Document 29L0011.E36997) for functional description and timing diagrams.

Refer to the IBM Application Note *Power Up and Power Management on DDR RDIMMs* for new DDR DIMM features that facilitate controlled power up and minimize power consumption.



Preliminary

IBM16M64644HGA IBM16M32644HGA
IBM16M64734HGA IBM16M32734HGA
32/64Mx64/72 1 or 2 Bank Registered DDR SDRAM Module

Layout Drawing for 32Mx64/x72 1 Bank Registered DIMM

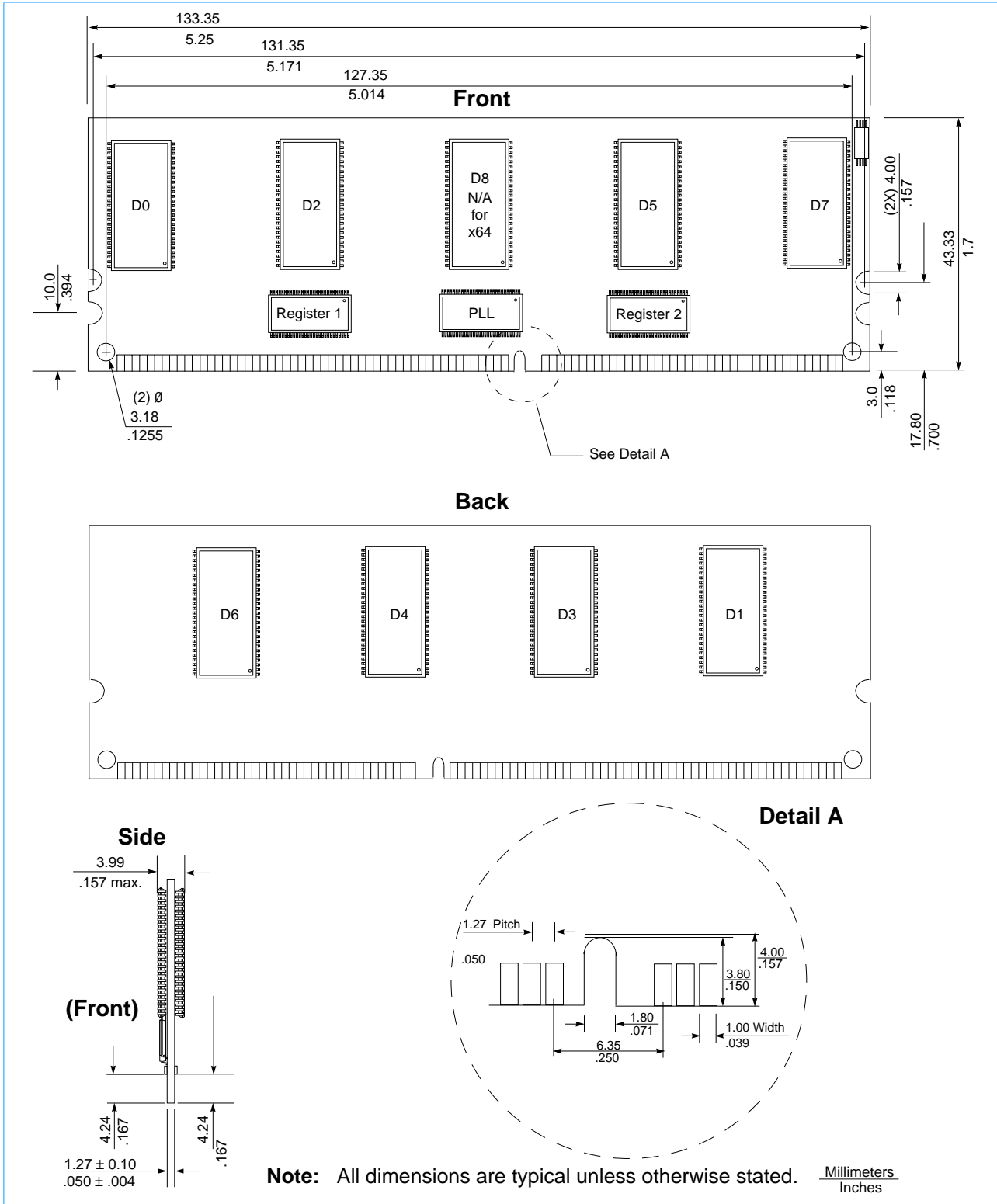

Layout Drawing for 32Mx64/x72 2 Bank Registered DIMM

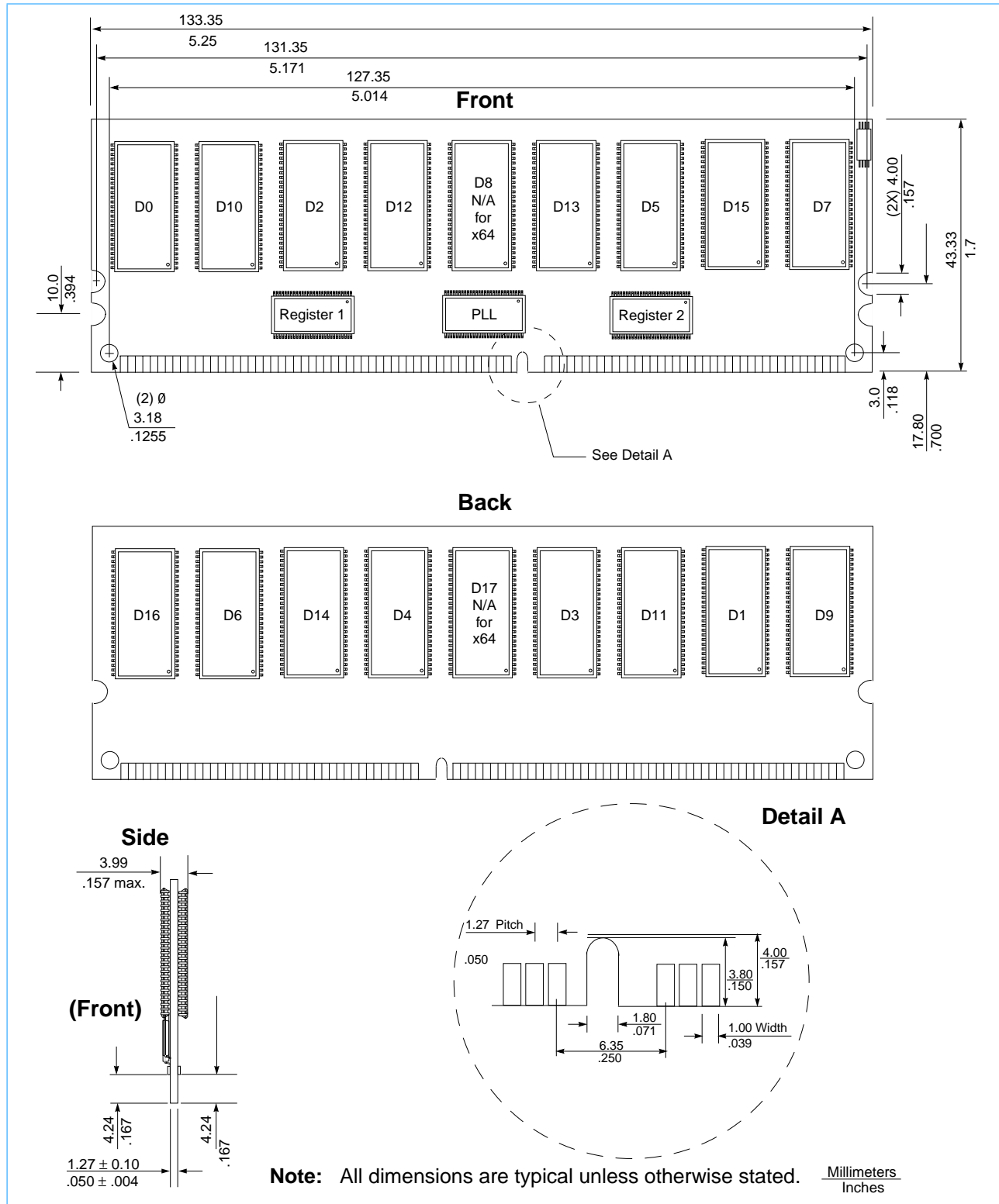



IBM16M64644HGA IBM16M32644HGA
IBM16M64734HGA IBM16M32734HGA

Preliminary

32/64Mx64/72 1 or 2 Bank Registered DDR SDRAM Module

Revision Log

Rev	Contents of Modification
3/00	Initial release.



© Copyright International Business Machines Corporation 1999, 2000

All Rights Reserved
Printed in the United States of America March 2000

The following are trademarks of International Business Machines Corporation in the United States, or other countries, or both.

IBM IBM Logo

Other company, product and service names may be trademarks or service marks of others.

All information contained in this document is subject to change without notice. The products described in this document are NOT intended for use in implantation or other life support applications where malfunction may result in injury or death to persons. The information contained in this document does not affect or change IBM product specifications or warranties. Nothing in this document shall operate as an express or implied license or indemnity under the intellectual property rights of IBM or third parties. All information contained in this document was obtained in specific environments, and is presented as an illustration. The results obtained in other operating environments may vary.

THE INFORMATION CONTAINED IN THIS DOCUMENT IS PROVIDED ON AN "AS IS" BASIS. In no event will IBM be liable for damages arising directly or indirectly from any use of the information contained in this document.

IBM Microelectronics Division
1580 Route 52, Bldg. 504
Hopewell Junction,
NY 12533-6351

The IBM home page can be found at
<http://www.ibm.com>

The IBM Microelectronics Division home page
can be found at <http://www.chips.ibm.com>

19L7358.0H2502.
3/00