

LAN Components TLA Series

Conformity to RoHS Directive

PULSE TRANSFORMERS

TLA-3T101LF(-T)/108LF(-T) ISO8802.3(IEEE802.3) 10BASE2/5/-T

FEATURES

- Product conforming to RoHS directive.
- Can be mounted with lead-free solder (260°C max.).
- 16-pin SMD package(1.27mm=50mil pin pitch).
- Using the high-quality and wide-band ferrite cores for LAN.
- Packaging specification is taping and bulk(TLA-3T10□LF-T: Tape and reel, TLA-3T10 □LF: Bulk).

GENERAL SPECIFICATIONS

Pulse transformer	3	
Port	1	
Temperature ranges	Operating	0 to +70°C
	Storage	-40 to +85°C
Withstanding voltage	Erms:2000V[60s]	

SHAPES AND DIMENSIONS

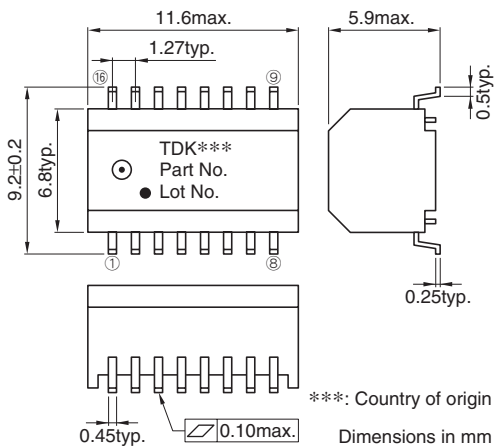

CIRCUIT DIAGRAM

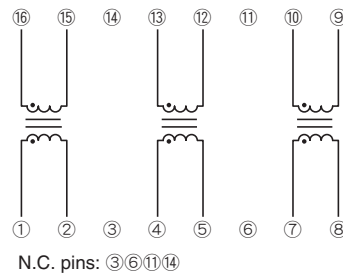

RECOMMENDED PC BOARD PATTERN

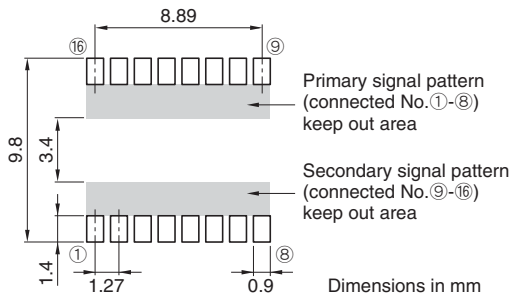

ELECTRICAL CHARACTERISTICS

Part No.	Turns ratio ①②:⑯⑰ ④⑤:⑬⑭ ⑦⑧:⑩⑨	Inductance (μH)typ.[100kHz]	Leakage inductance (μH)max.[100kHz] ①-②[⑯-⑰ shorted] ④-⑤[⑬-⑭ shorted] ⑦-⑧[⑩-⑨ shorted]	Inter-winding stray capacitance (pF)max.[100kHz] ①②-⑯⑰ ④⑤-⑬⑭ ⑦⑧-⑩⑨	DC resistance (Ω)max. ①-②,⑯-⑰ ④-⑤,⑬-⑭ ⑦-⑧,⑩-⑨
TLA-3T101LF(-T)	1:1	100	0.25	10	0.35, 0.35
TLA-3T108LF(-T)	1:1	75	0.25	10	0.35, 0.35

• Ta=25°C

• Conformity to RoHS Directive: This means that, in conformity with EU Directive 2002/95/EC, lead, cadmium, mercury, hexavalent chromium, and specific bromine-based flame retardants, PBB and PBDE, have not been used, except for exempted applications.

• All specifications are subject to change without notice.

PACKAGING STYLES

Quantity : 1000pieces/reel

TAPE DIMENSIONS

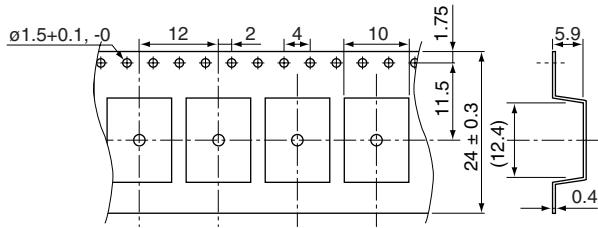

Dimensions in mm

REEL DIMENSIONS

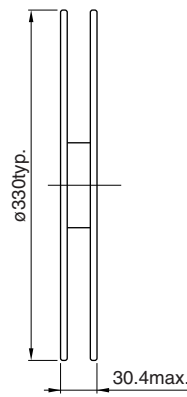
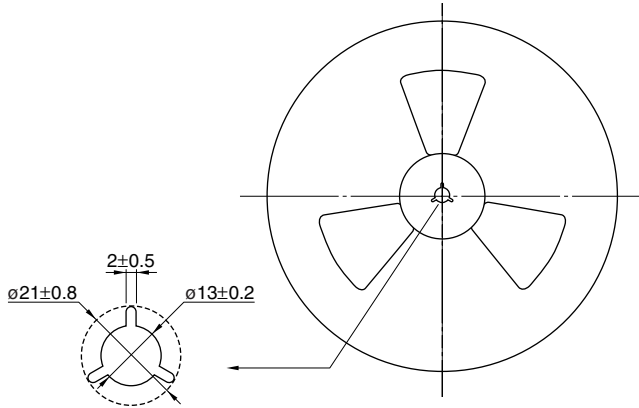

Dimensions in mm

RECOMMENDED SOLDERING CONDITION

REFLOW SOLDERING

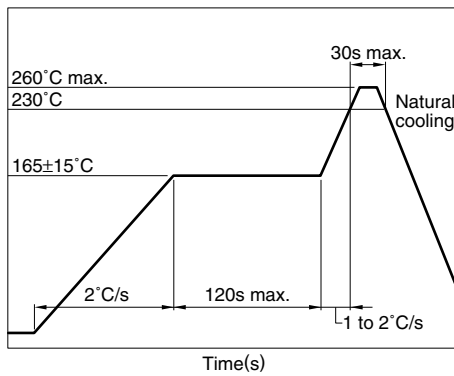

- Temperature is measured at the terminal portion of product (Using thermocoupler for measurement).
- This profile is reference data we recommend. Please check in your actual process.
- For reliable soldering, the thickness of solder paste screen should be over the terminal co-planality.
- The cutted end of terminal has no plating(out of subject of solder ability).

RECOMMENDED CONDITION FOR LONG TERM STORE

When it stores for a long term, please avoid place of high temperature and high humidity. Recommend that it uses after the delivery within 1year.

Temperature range: +5 to +30°C

Humidity: 60(%)RH max.