

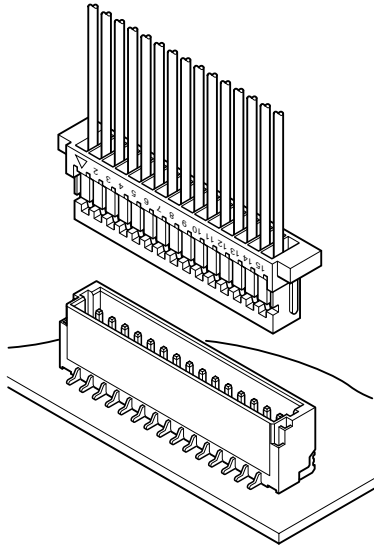

# SH CONNECTOR

1.0mm pitch/Disconnectable Crimp style connectors



The world's first 1.0mm pitch crimp style connector.

- Compact, low profile design
- Compatible with the SR insulation displacement connectors
- Housing lances

## Specifications

- Current rating: 1.0A AC, DC (AWG #28)
  - Voltage rating: 50V AC, DC
  - Temperature range: -25°C to +85°C  
(including temperature rise in applying electrical current)
  - Contact resistance: Initial value/20m Ω max.  
After environmental testing/40m Ω max.
  - Insulation resistance: 100M Ω min.
  - Withstanding voltage: 500V AC/minute
  - Applicable wire: Conductor size/AWG #32 to #28  
Insulation O.D./0.4 to 0.8mm
- \* RoHS compliant products are published.  
\* Refer to "General Instruction and Notice when using Terminals and Connectors" at the end of this catalog.  
\* Contact JST for details.

## Standards

- Ⓜ Recognized E60389
- Ⓢ Certified LR20812

## PC board layout (viewed from component side) and Assembly layout

### Top entry type

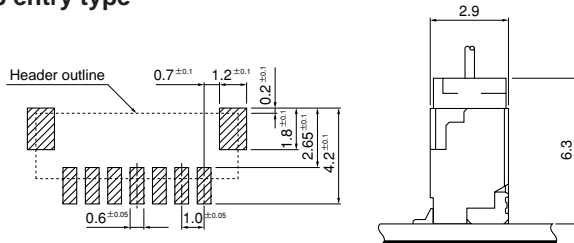

### Side entry type

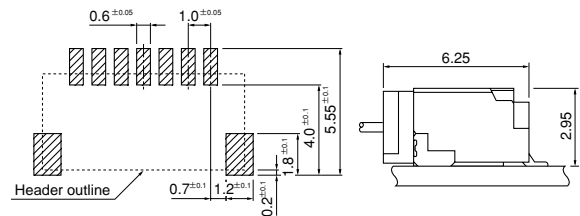

Note: 1. Tolerances are non-cumulative:  $\pm 0.05\text{mm}$  for all centers.  
2. The dimensions above should serve as a guideline. Contact JST for details.

## Contact

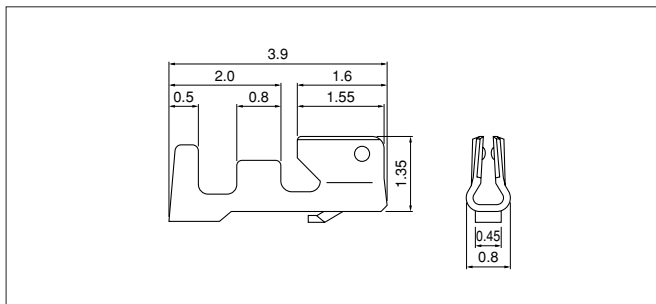

Model No.	Applicable wire			Qty / reel
	mm <sup>2</sup>	AWG#	Insulation O.D. (mm)	
SSH-003T-P0.2-H	0.032 ~ 0.08	32~28	0.4~0.8	23,000

### Material and Finish

Phosphor bronze, tin-plated (reflow treatment)

### RoHS compliance

Note: Contact JST for gold-plated products.

Contact	Crimping machine	Applicator		
		Crimp applicator	Dies	Crimp applicator with dies
SSH-003T-P0.2-H	AP-K2N	MKS-L-10-3	MK/SSH/L-003-02	APLMK SSH/L003-02
		*MKS-SC	SC/SSH/L-003-02	APLSC SSH/L003-02

Note: \*Strip-crimp applicator  
Contact JST for applicable wires in case that it is not usable due to wire size.

# SH CONNECTOR

## Housing

### With protrusions

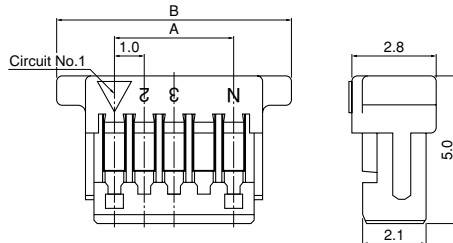

### Without protrusions

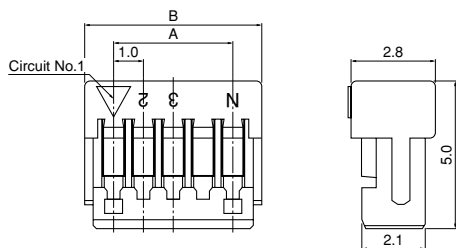

Circuits	Model No.		Dimensions (mm)			Q'ty / box
	With protrusions	Without protrusions	A	B		
2	SHR-02V-S-B	SHR-02V-S	1.0	5.0	3.0	2,000
3	SHR-03V-S-B	SHR-03V-S	2.0	6.0	4.0	2,000
4	SHR-04V-S-B	SHR-04V-S	3.0	7.0	5.0	2,000
5	SHR-05V-S-B	SHR-05V-S	4.0	8.0	6.0	2,000
6	SHR-06V-S-B	SHR-06V-S	5.0	9.0	7.0	2,000
7	SHR-07V-S-B	SHR-07V-S	6.0	10.0	8.0	2,000
8	SHR-08V-S-B	SHR-08V-S	7.0	11.0	9.0	2,000
9	SHR-09V-S-B	SHR-09V-S	8.0	12.0	10.0	2,000
10	SHR-10V-S-B	SHR-10V-S	9.0	13.0	11.0	2,000
11	SHR-11V-S-B	SHR-11V-S	10.0	14.0	12.0	2,000
12	SHR-12V-S-B	SHR-12V-S	11.0	15.0	13.0	2,000
13	SHR-13V-S-B	SHR-13V-S	12.0	16.0	14.0	2,000
14	SHR-14V-S-B	SHR-14V-S	13.0	17.0	15.0	2,000
15	SHR-15V-S-B	SHR-15V-S	14.0	18.0	16.0	2,000
20	SHR-20V-S-B	—	19.0	23.0	21.0	1,000

### Material

PBT, UL94V-0, natural (white)

### RoHS compliance

## Shrouded header

The shrouded headers are interchangeable with those of the SR insulation displacement connectors.

### Top entry type

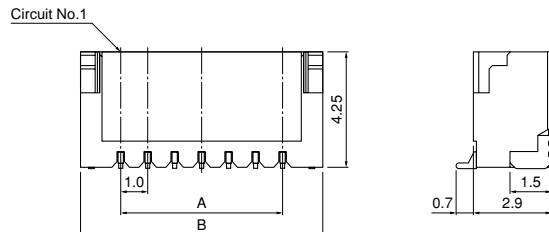

### Side entry type

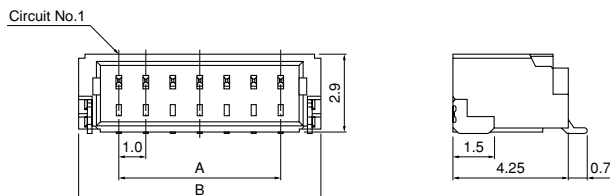

Circuits	Model No.		Dimensions (mm)		Q'ty / reel	
	Top entry type	Side entry type	A	B	Top entry type	Side entry type
2	BM02B-SRSS-TB	SM02B-SRSS-TB	1.0	4.0	1,500	3,000
3	BM03B-SRSS-TB	SM03B-SRSS-TB	2.0	5.0	1,500	3,000
4	BM04B-SRSS-TB	SM04B-SRSS-TB	3.0	6.0	1,500	3,000
5	BM05B-SRSS-TB	SM05B-SRSS-TB	4.0	7.0	1,500	3,000
6	BM06B-SRSS-TB	SM06B-SRSS-TB	5.0	8.0	1,500	3,000
7	BM07B-SRSS-TB	SM07B-SRSS-TB	6.0	9.0	1,500	3,000
8	BM08B-SRSS-TB	SM08B-SRSS-TB	7.0	10.0	1,500	3,000
9	BM09B-SRSS-TB	SM09B-SRSS-TB	8.0	11.0	1,500	3,000
10	BM10B-SRSS-TB	SM10B-SRSS-TB	9.0	12.0	1,500	3,000
11	BM11B-SRSS-TB	SM11B-SRSS-TB	10.0	13.0	1,500	3,000
12	BM12B-SRSS-TB	SM12B-SRSS-TB	11.0	14.0	1,500	3,000
13	BM13B-SRSS-TB	SM13B-SRSS-TB	12.0	15.0	1,500	3,000
14	BM14B-SRSS-TB	SM14B-SRSS-TB	13.0	16.0	1,500	3,000
15	BM15B-SRSS-TB	SM15B-SRSS-TB	14.0	17.0	1,500	3,000
20	—	SM20B-SRSS-TB	19.0	22.0	—	3,000

### Material and Finish

Contact: Copper alloy, copper-undercoated, tin-plated (reflow treatment)  
Housing: PA, UL94V-0, natural (ivory)  
Solder tab: Brass, copper-undercoated, tin-plated (reflow treatment)

### RoHS compliance

This product displays (LF)(SN) on a label.  
Note: 1. The products listed above are supplied on embossed-tape.  
2. Contact JST for the headers with gold-plated pins.  
3. Contact JST for the top entry type headers with suction cap.

# SH CONNECTOR

## Taping specifications

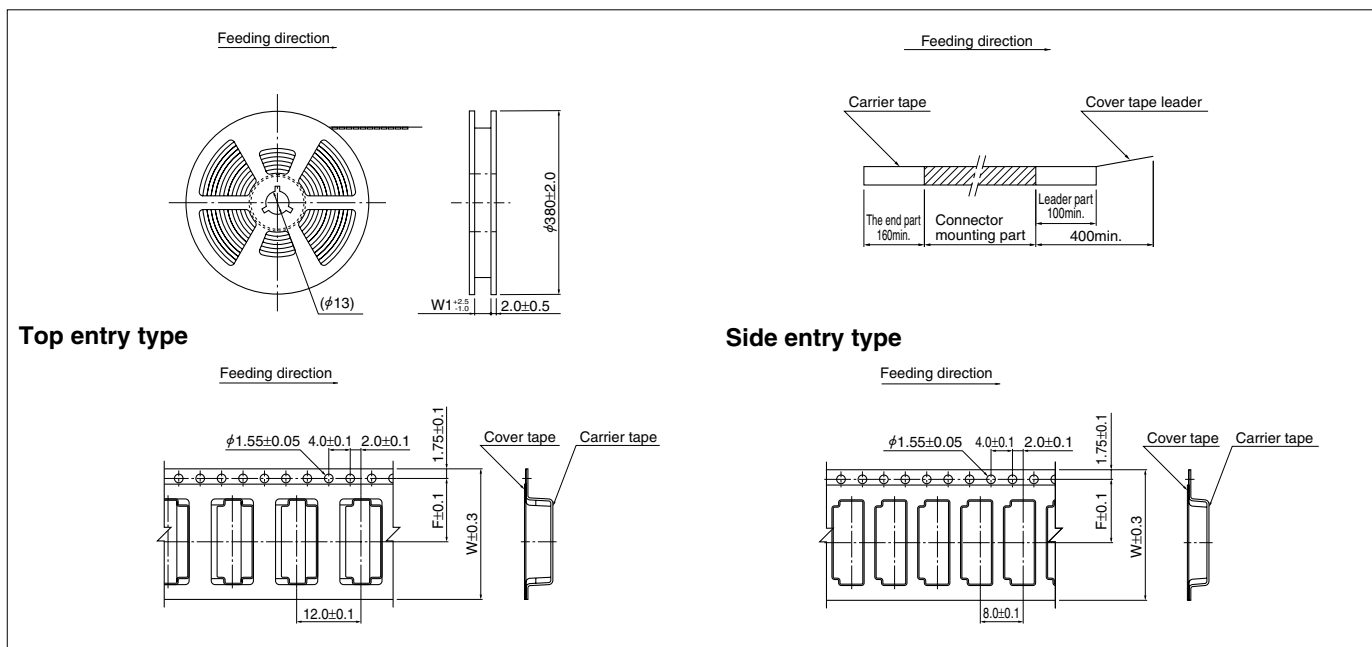

Circuits	Taping dimensions (mm)				Reel dimensions (mm)		Q'ty / reel	
	F		W		W1		Top entry type	Side entry type
	Top entry type	Side entry type	Top entry type	Side entry type	Top entry type	Side entry type		
2	5.5	5.5	12.0	12.0	13.5	13.5	1,500	3,000
3	5.5	5.5	12.0	12.0	13.5	13.5	1,500	3,000
4	7.5	5.5	16.0	12.0	17.5	13.5	1,500	3,000
5	7.5	7.5	16.0	16.0	17.5	17.5	1,500	3,000
6	7.5	7.5	16.0	16.0	17.5	17.5	1,500	3,000
7	7.5	7.5	16.0	16.0	17.5	17.5	1,500	3,000
8	11.5	7.5	24.0	16.0	25.5	17.5	1,500	3,000
9	11.5	11.5	24.0	24.0	25.5	25.5	1,500	3,000
10	11.5	11.5	24.0	24.0	25.5	25.5	1,500	3,000
11	11.5	11.5	24.0	24.0	25.5	25.5	1,500	3,000
12	11.5	11.5	24.0	24.0	25.5	25.5	1,500	3,000
13	11.5	11.5	24.0	24.0	25.5	25.5	1,500	3,000
14	11.5	11.5	24.0	24.0	25.5	25.5	1,500	3,000
15	11.5	11.5	24.0	24.0	25.5	25.5	1,500	3,000
20	-	20.2	-	44.0	-	45.5	-	3,000

Note: 1. Specifications conform to JIS C 0806. The tape width, connector loading recess square hole dimensions, etc. are determined by the number of circuits and external shape of the connector to be loaded.  
 2. Specifications are subject to change without prior notice.